

\$8.40

## Theory of Operation

### COMPUTER MODEL 920

SDS 900005D

March 1966



SCIENTIFIC DATA SYSTEMS • 1649 Seventeenth Street • Santa Monica, Calif. • (213) 871-0960

## PREFACE

The SDS 900 Series Computers are solid state, general purpose, digital machines which use a parallel, random access, coincident current, magnetic core memory and serial arithmetic operation.

These computers are completely modular, contain all silicon components, and have positive true logic. Internal operations are binary and two's complement arithmetic is used.

This manual is presented in four sections. These cover Computer Logic, W Buffer and Input/Output Operations, Magnetic Core Memory, and BCD Typewriter and Tape Punch. Each section has its own lists of Contents and Illustrations which define the referenced pages.

## TABLE OF CONTENTS

Section		Page
I	COMPUTER LOGIC	
	INTRODUCTION	1.1
	BASIC COMPUTER STRUCTURE AND OPERATION	1.3
	INSTRUCTION AND WORD FORMAT	1.7
	Instruction Format	1.7
	Data Word Format	1.8
	Two's Complement Arithmetic	1.8
	PULSE COUNTER	1.15
	Pulse Decoding	1.16
	PHASE CONTROL	1.17
	Phases	1.17
	Phase Counter	1.18
	Single-Cycle Instructions	1.20
	Two-Cycle Instructions	1.20
	Three-Cycle Conditional Skip Instructions	1.21
	Two-Cycle Conditional Skip Instructions	1.21
	Three-Cycle Memory Increment or Decrement Instructions	1.22
	Multiplication and Division Instructions	1.23
	N-Cycle Shift Instructions	1.23
	Three-Cycle Plus N Output Instructions	1.24
	Four-Cycle Plus N Input Instructions	1.24
	Three-Cycle Store Instructions	1.25
	One-Cycle Unconditional Branch Instructions	1.26
	Program Operator Instructions	1.26
	REGISTERS	1.27
	P Register	1.27
	S Register	1.28

## Contents

### TABLE OF CONTENTS (Cont.)

Section	Page
M Register	1.29
C Register	1.32
O Register	1.33
A Register	1.34
B Register	1.35
X Register	1.35
Word Assembly Register (WAR)	1.36
MEMORY CONTROL	1.39
ADDER	1.43
INSTRUCTION OPERATORS	1.45
Index Operation	1.45
Indirect Address Operation	1.46
Program Operator	1.46
MANUAL AND TIMING CONTROL	1.51
Interrupt	1.51
Time-Share (Memory Interlace)	1.58
Control Switch	1.61
Register Switch	1.65
Manual Control Switches	1.67
Start and Fill Switches	1.69
INSTRUCTIONS	1.73
Skip and Branch Instructions (01, 40, 50, 52, 53, 70, 72, 73, 74, 41, 43, 51)	1.73
Memory Increment Instructions (60, 61)	1.79
Store Instructions (35, 36, 37)	1.79
Load Instructions (71, 75, 76, 77)	1.80
Input Instructions (30, 32, 33)	1.81
Output Instructions (10, 12, 13)	1.83

## TABLE OF CONTENTS (Cont.)

Section	Page
Control Instructions (23, 00, 02, 20)	1.84
Logical Instructions (14, 16, 17)	1.85
Register Change Instructions (46)	1.86
Shift Instructions (66, 67)	1.87
Arithmetic Instructions (54, 55, 56, 57, 63, 64, 65)	1.91
Multiply Example	1.95
Divide Example	1.100
MEMORY PARITY	1.101
Parity Generation	1.101
Parity Checking	1.101
IMPLEMENTATION	1.103
Gates	1.103
Inverters, Buffer Amplifiers and Flip-Flops	1.106
DICTIONARY OF COMPUTER LOGIC TERMS	1.111
CONDENSED COMPUTER LOGIC EQUATIONS	1.117
A Register	1.117
B Register	1.119
C Register	1.121
S Register	1.143
Scope Signals	1.152
SKS	1.154
X Register	1.156
II	
W BUFFER AND INPUT/OUTPUT OPERATIONS	
INTRODUCTION	2.1
GENERAL W BUFFER OPERATION	2.3
Input Process ( $\overline{W9}$ )	2.6
Output Process ( $W9$ )	2.17

## Contents

### TABLE OF CONTENTS (Cont.)

Section	Page
Scan ( $\overline{W9}$ W10 W11)	2.28
Erase (W9 W10 W11)	2.29
Fill	2.31
Time-Share Interlace	2.32
Photo-Reader 1	2.38
DICTIONARY OF BUFFER LOGIC TERMS	2.41
W BUFFER AND INPUT/OUTPUT EQUATIONS	2.45
Unit Address Register	2.45
Input/Output	2.45
Character Counter	2.45
Clock Counter	2.46
Computer Interlock	2.46
Interrupt Signals	2.46
Time-Share Calling Signal	2.46
Halt Detector	2.47
Error Detector	2.47
Single Character Register	2.47
Load W from C	2.48
Clock Signal	2.48
Word Assembly Register	2.49
Clear and Set Signals	2.49
Halt Interlock	2.49
Magnetic Tape Control Signals	2.49
INTERLACE LOGIC	2.50
PHOTO-READER 1	2.52
Enable Signal	2.52
Pinch Roller and Lamp Drivers	2.52

## TABLE OF CONTENTS (Cont.)

Section	Page
Reader Signals	2.52
Brake Driver	2.52
Y BUFFER OPERATIONS	2.53
Y BUFFER EQUATIONS	2.55
Unit Address Register	2.55
Input/Output	2.55
Character Counter	2.55
Clock Counter	2.56
Computer Interlock	2.56
Interrupt Signals	2.56
Time-Share Calling Signal	2.56
Halt Detector	2.57
Error Detector	2.57
Single Character Register	2.57
Load Y from C	2.58
Clock Signal	2.58
Word Assembly Register	2.59
Clear and Set Signals	2.59
Halt Interlock	2.59
Magnetic Tape Control Signals	2.59
III	
MAGNETIC CORE MEMORY	
INTRODUCTION	3.1
MAGNETIC CORE STORAGE THEORY	3.5
BASIC OPERATION	3.9
Addressing	3.9
Read Cycle	3.13
Write Cycle	3.16

## Contents

### TABLE OF CONTENTS (Cont.)

Section	Page
MEMORY EXPANSION	3.19
MODULE OPERATION	3.21
Decoder	3.21
Selector Control	3.21
XY Selector	3.21
Current Regulator	3.24
Voltage Regulator	3.24
Z Driver	3.24
Sense Amplifier	3.24
Discriminator	3.28
IV BCD TYPEWRITER AND TAPE PUNCH	
INTRODUCTION	4.1
Functional Description	4.3
TYPEWRITER CODES	4.4
Theory of Operation - Input	4.5
Theory of Operation - Output	4.7
Adjustments	4.10
DICTIONARY OF BCD TYPEWRITER LOGIC TERMS	4.15
BCD TYPEWRITER LOGIC EQUATIONS	4.17
TAPE PUNCH	4.19
Functional Description	4.19
Theory of Operation	4.19
Circuit Considerations	4.24
Adjustments	4.24
DICTIONARY OF TAPE PUNCH LOGIC TERMS	4.29
TAPE PUNCH LOGIC EQUATIONS	4.30



## LIST OF ILLUSTRATIONS

Figure	Title	Page
1	Basic Computer Structure Information Flow	1.4
2	Instruction List	1.10
3	Instruction Decoding	1.13
4	Pulse Sequence	1.14
5	Phase Sequence Chart	1.19
6	Accessing an Instruction	1.31
7	Computer Memory Cycle	1.40
8	Program Operator	1.49
9	Priority Interrupt System	1.52
10	Interrupt Timing A	1.54
11	Interrupt Timing B	1.55
12	Interrupt Timing C	1.56
13	Interrupt Timing D	1.57
14	Interlace Timing (Time-Share)	1.60
15	Control Switch	1.63
16	Control Panel	1.64
17	Timing: Instruction 41 (BRX)	1.76
18	Timing: Instructions 30, 32	1.82
19	W Buffer Information Flow	2.5
20	Input Timing Chart	2.7
21	Input Signal Characteristics	2.9
22	Information Flow Diagram Phototape	2.10
23	Termination Timing A Phototape Input	2.12
24	Termination Timing B Phototape Input	2.13
25	Information Flow Diagram Magnetic Tape	2.14
26	Input Timing Magnetic Tape	2.15
27	Input Termination Timing Magnetic Tape	2.16

## Illustrations

### LIST OF ILLUSTRATIONS (Cont.)

Figure	Title	Page
28	Flow Diagram Output Process	2. 18
29	Output Timing Chart 1	2. 20
30	Output Timing Chart 2	2. 21
31	Output Termination Timing (Except Magnetic Tape)	2. 22
32	Output Termination Timing Magnetic Tape	2. 23
33	Output Timing Chart Punch	2. 24
34	Output Timing Chart Magnetic Tape	2. 26
35	Forward Scan Timing Magnetic Tape	2. 27
36	Reverse Scan Timing Magnetic Tape	2. 30
37	Information Flow Diagram Interlace Operation	2. 33
38	Loading the Interlace Register	2. 35
39	Input/Output Timing Time-Share	2. 36
40	Input Termination Timing Time-Share	2. 37
41	Block Diagram - Magnetic Core Memory	3. 2
42	Hysteresis Loop	3. 5
43	Memory Block Diagram	3. 11
44	Operation of Address 3037	3. 12
45	Computer Memory Cycle	3. 14
46	Memory Digit Plane Diagram	3. 15
47	Block Diagram - Memory Expansion	3. 20
48	Decoder and Selector Control Logic	3. 22
49	XY Selector Logic	3. 23
50	Voltage Regulator and Current Regulator	3. 25
51	Z Driver Schematic	3. 26
52	Sense Amplifier and Discriminator Logic	3. 27
53	Typewriter Inputs	4. 12
54	Typewriter Output Cycle - Lower Case Characters	4. 13

## LIST OF ILLUSTRATIONS (Cont.)

Figure	Title	Page
55	Typewriter Outputs - Lower Case Character - Upper Case Character - Lower Case Character	4. 14
56	Manually Controlled Paper Feed	4. 20
57	Punching Data with Leader	4. 26
58	Punching Data with No Leader and Toggle Switch in "Auto"	4. 27
59	Punching Data with No Leader and Toggle Switch in "Run"	4. 28

SECTION I  
COMPUTER LOGIC

## INTRODUCTION

The Computer Logic Section describes the logical operation of the computer in detail. It is primarily intended for engineering, checkout, training and maintenance use. Descriptions are presented with the assumption that the reader has a working knowledge of Boolean algebra and basic digital operations.

For proper use of this publication, the reader should be familiar with the SDS Reference Manual for this computer.



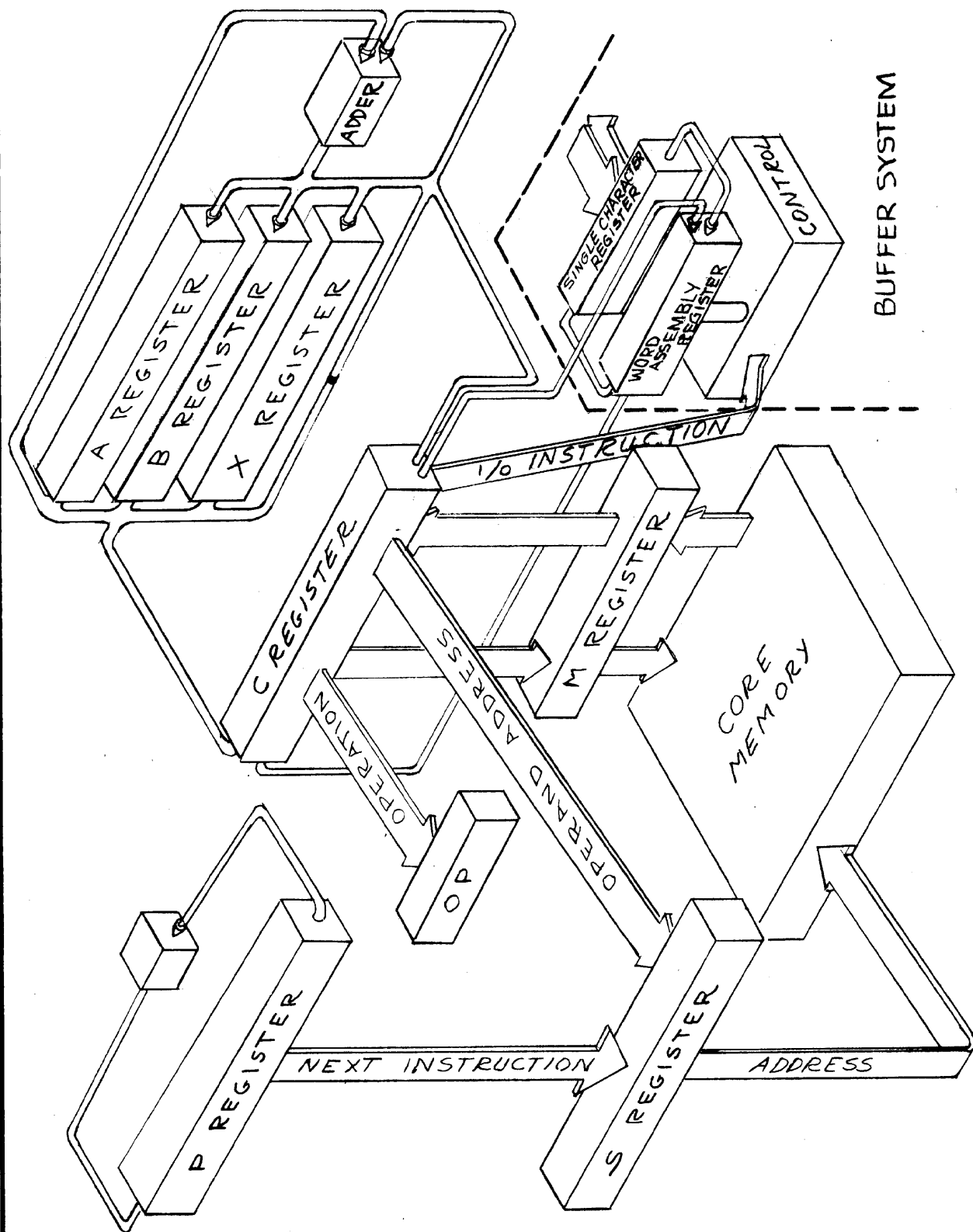

FIGURE 1  
 BASIC COMPUTER STRUCTURE  
 INFORMATION FLOW

Depending upon the instruction to be executed, the address field containing the memory address of the desired operand is transferred in parallel to the S register. For example, the M register accepts the operand from memory and transfers it in parallel to the C register. At this point the code of the operation to be performed is held in the O register and the operand, upon which the operation is to be performed, is held in the C register.

During the execution of the instruction the operand is serially shifted out of the C register and into the Word Assembly register (WAR), Adder, A register, B register, or X register.

During the execution of "Store" instructions the operand address of the instruction is transferred to the S register to set up the Store address. The data to be stored is then shifted into the C register from its present location, and the information is transferred in parallel to the M register which stores it in memory.

To communicate with external devices such as a photo-reader, magnetic tape unit, punch and typewriter, the computer uses the WAR with its associated single character register (SCR) as shown in Figure 1. During an input process 6-bit characters from the external device are transferred into the SCR in parallel. When the Buffer "control" detects that a character has been received, it shifts the character into the WAR, and when the WAR contains the desired number of characters, a signal is sent to the computer to store the information held in the WAR into memory.

On output, the inverse operation is used; the information is shifted from the C register to the WAR and the computer returns to its previous program. The WAR now shifts one character at a time into the SCR where it is sent out in parallel to the external device in operation. When the buffer control detects that the WAR is empty, it signals the computer to load the WAR with another word for output.

When studying the information which follows, frequently refer to the Reference Manual to properly integrate the programming nomenclature and discussion with that of the internal operation.



## LOGICAL DESCRIPTION

## INSTRUCTION AND WORD FORMAT

The instruction list for the computer is shown in Figure 2. The instructions are numbered from 00 through 77 octally and are listed with their respective mnemonic codes and execution times. The execution time for a specific instruction is the number of word times (machine cycles) which elapse during the accessing of the instruction and its complete execution, including the accessing or storing of any operands.

### INSTRUCTION FORMAT

The instruction format is:

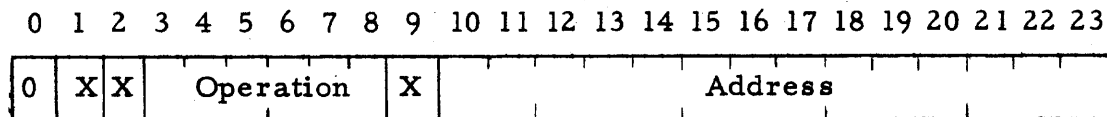

- 0 : Relative address bit (not used in logic)
- 1 : Index bit
- 2 : Program operator
- 3 —————> 8 : 6-bit instruction code
- 9 : Indirect address bit
- 10 —————> 23 : 14-bit address

The programming functions of the above fields are:

#### Index Register Bit:

A "1" in this position causes the contents of bits 10 through 23 of the index register (X register) to be added to the address portion of the instruction prior to execution.

#### Program Operator Bit:

A "1" in this position causes the program operator bit and the 6 bits of the instruction code to be interpreted as an entry address for a subroutine.

#### Instruction Code:

The 6 bits of the instruction code contain the 2-digit octal code for the instruction to be executed. This information is transferred to the "O" register flip-flops, 01, 02, 03, 04, 05, and 06.

### Indirect Address Bit:

A "1" in this position causes the computer to interpret bits 10 through 23 of the instruction (possibly modified by indexing) as the memory location where the effective address of the instruction may be found. A "0" causes bits 10 through 23 of the instruction to be interpreted as the effective address.

### Address:

The address is defined by bits 10 through 23 of the instruction. The address generally represents the memory location of the operand.

### DATA WORD FORMAT

The data word format is:

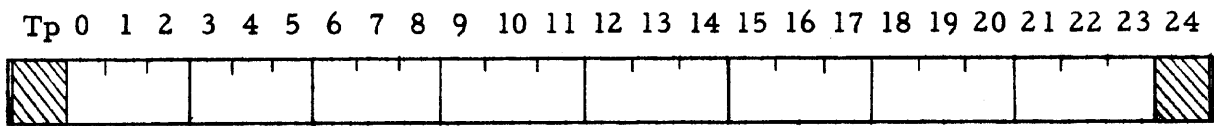

Arithmetic is performed using the binary two's complement number system. The sign bit can then be considered to be integral with the data word. Data words consist of eight octal digits, each octal digit consisting of three binary digits (bits).

During all serial operations the 23rd bit position (least significant end) appears first in time.

### TWO'S COMPLEMENT ARITHMETIC

Considering the machine to be a fixed point, fractional computer, using two's complement arithmetic, any number stored in memory can be expressed by the following general formula:

$$N = A_0 (-2^0) + A_1 (+2^{-1}) + A_2 (+2^{-2}) + \dots + A_{23} (+2^{-23}),$$

or it can be expressed as:

$$N = \sum_{i=1}^{23} A_i (2^{-i}) - A_0$$

From this it can be seen that the largest allowable positive number is:

$$0.111111111111111111111111$$

The minimum positive number is:

0.000000000000000000000000

The maximum negative number is:

1.000000000000000000000000

The minimum negative number is:

1.111111111111111111111111

Numbers of negative magnitude are expressed in two's complement form and arithmetic operations, where the operands and answers are within the allowable range, maintain the negative numbers in two's complement form.

Time	Code	Mne- monic	Function	Time	Code	Mne- monic	Function
1	00	HLT	Halt	1, 2	40	SKS	Skip if M not set
1	01	BRU	Branch to M	1, 2	41	BRX	(X) + 1 → X, branch if X9 = 1
1	02	EOM	Energize M	2	42	BRM	(P) → M, BRU → M + 1
	03				43		
	04				44		
	05				45		
	06			1	46	*	
	07				47		
2+	10	MIY	(M) → Y when ready	2, 3	50	SKE	Skip if (A) = (M)
	11			2	51	BRR	(M) + 1 → P (BRU)
2+	12	MIW	(M) → W when ready	2, 3	52	SKB	No skip if (B)(M) = 1 anywhere
3+	13	POT	Parallel out, when ready	2, 3	53	SKN	Skip if (M) negative
2	14	ETR	Extract	2	54	SUB	(A) - (M) → A
	15			2	55	ADD	(A) + (M) → A
2	16	MRC	Merge: (A) or (M) → A	2	56	SUC	(A) - (M) - Carry → A
2	17	EOR	Exclusive OR	2	57	ADC	(A) + (M) + Carry → A

\* Instructions where the address is used in addition to the instruction code to define the specific operation (See page 1.12)

FIGURE 2  
INSTRUCTION LIST

Time	Code	Mne- monic	Function	Time	Code	Mne- monic	Function
1	20	NOP	No operation	3	60	SKR	(M) - 1 → M Skip if negative
	21			3	61	MIN	(M) + 1 → M
	22			3	62	XMA	(M) ← (A) (Exchange)
1	23	EXU	Execute	3	63	ADM	(M) + (A) → M
	24			4	64	MUL	Multiply
	25			28	65	DIV	Divide
	26			**	66	*	** 2 + N/2 even
	27			**	67	*	2 + (N + 1)/2 odd
3+	30	YIM	(Y) → M when ready	2, 3	70	SKM	Skip if (A) = (M) on B mask
	31			2	71	LDX	(M) → X
3+	32	WIM	(W) → M when ready	2, 3	72	SKA	No skip if (A) (M) = 1 anywhere
4+	33	PIN	Parallel in, when ready	2, 3	73	SKG	Skip if (A) > (M)
	34			2, 3	74	SKD	Difference Exponents and Skdp
3	35	STA	(A) → M	2	75	LDB	(M) → B
3	36	STB	(B) → M	2	76	LDA	(M) → A
3	37	STX	(X) → M	2	77	EAX	Eff. address → X

\* Instructions where the address is used in addition to the instruction code to define the specific operation (see page 1.12).

FIGURE 2  
INSTRUCTION LIST (CONTINUED)

### Instruction code 46

The specific operation to be executed for instruction code 46 is determined by the bits in the address portion of the instruction as follows:

#### Address Bit

23	Clear A
22	Clear B
21	Copy (A) into B
20	Copy (B) into A
19	Copy (B) into X
18	Copy (X) into B
17	Bits 15-23 only
16	Copy (X) into A
15	Copy (A) into X
14	Copy -(A) into A

where the above functions can operate simultaneously if they do not conflict.

### Instruction codes 66 and 67

66	0	00NN	Right shift AB
66	2	00NN	Right cycle AB
67	0	00NN	Left shift AB
67	2	00NN	Left cycle AB
67	1	00NN	Normalize AB

The last two digits of the address specify the number of shifts or cycles to take place.

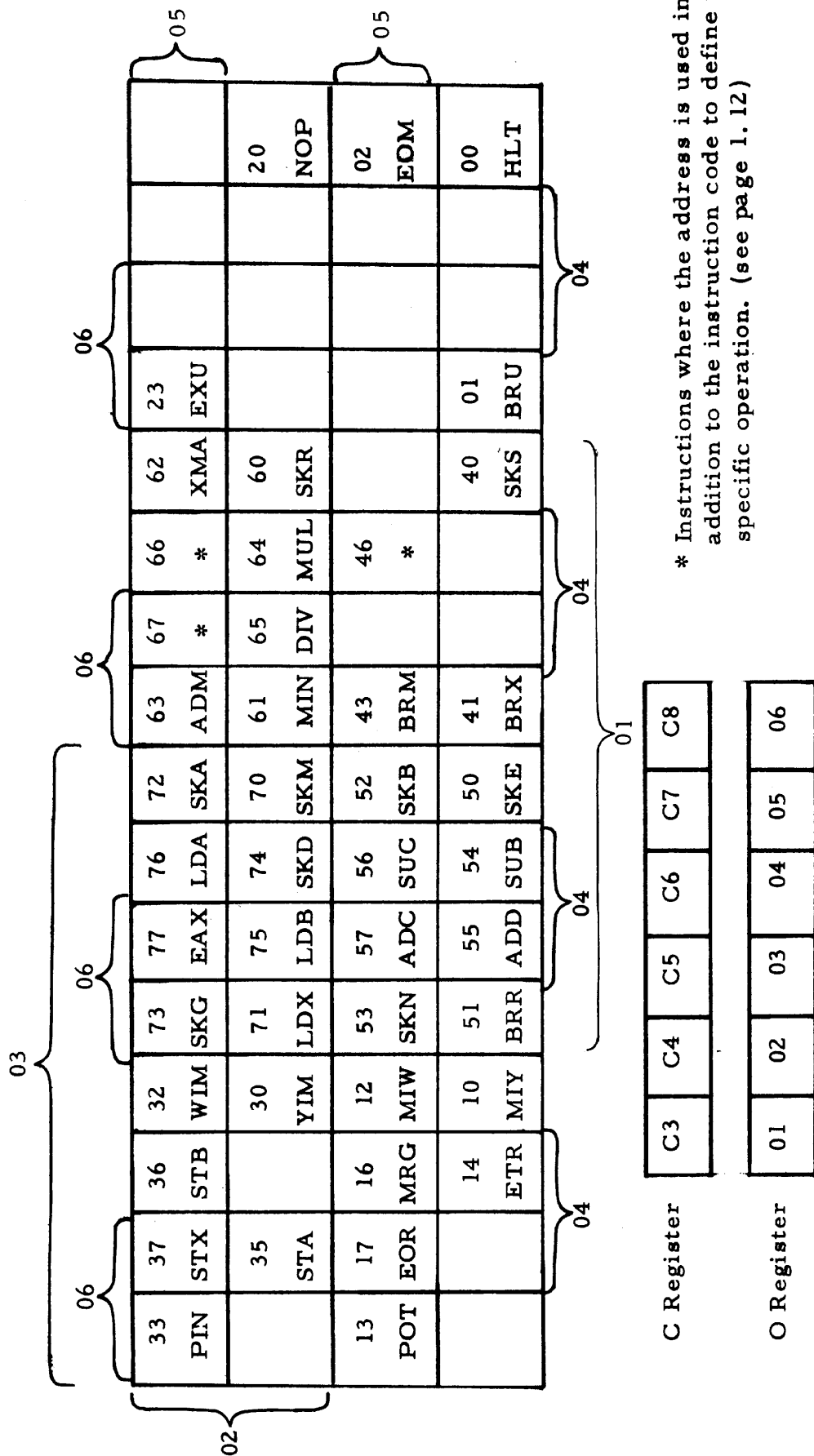

\* Instructions where the address is used in addition to the instruction code to define the specific operation. (see page 1.12)

FIGURE 3  
INSTRUCTION DECODING



PULSE COUNTER								
Gray Count	Pulse Time		Q1	Q2	Q3	Q4	Q5	Q6
0	T1	↓	0	0	0	0	0	1
1	T0		0	0	0	0	1	0
6	END Tp	↓	0	0	1	0	1	1
7	START T24		0	0	1	0	0	0
8	T23		0	1	1	0	0	1
9	T22		0	1	1	0	1	0
10	T21		0	1	1	1	1	1
11	T20		0	1	1	1	0	0
12	T19		0	1	0	1	0	1
13	T18		0	1	0	1	1	0
14	T17		0	1	0	0	1	1
17	T16		1	1	0	0	1	0
18	T15		1	1	0	1	1	1
19	T14		1	1	0	1	0	0
20	T13		1	1	1	1	0	1
21	T12		1	1	1	1	1	0
22	T11		1	1	1	0	1	1
23	T10	1	1	1	0	0	0	
24	T9	1	0	1	0	0	1	
25	T8	1	0	1	0	1	0	
26	T7	1	0	1	1	1	1	
27	T6	1	0	1	1	0	0	
28	T5	1	0	0	1	0	1	
29	T4	1	0	0	1	1	0	
30	T3	1	0	0	0	1	1	
31	T2	↓	1	0	0	0	0	

FIGURE 4  
PULSE SEQUENCE

## PULSE COUNTER

A pulse counter consisting of flip-flops Q1, Q2, Q3, Q4, Q5 and Q6 that counts the pulses that make up the twenty-six pulse times of each computer word.

The pulse counter is a modified gray code counter with Q1 as the most significant bit.

The gray code is off-set from the 26-bit pulse count and certain counts are eliminated to facilitate decoding and counter design.

Note that computer pulse times are designated in reverse order, with respect to time.

Q6 acts as a straight binary counter generating the output which is counted by the gray code counter Q1 through Q5.

$$\begin{aligned} sQ6 &= \overline{Q6} \\ rQ6 &= Q6 \end{aligned}$$

The least significant gray code stage Q5 counts in gray sequence with the addition of (Q1 + Q3) on the reset side to force a skip of gray counts 15 and 16.

$$\begin{aligned} sQ5 &= \overline{Q5} Q6 \\ rQ5 &= Q5 Q6 (Q1 + Q3) \end{aligned}$$

Q4 counts in gray sequence with the addition of (Q1 + Q3) on the set side to force the skip of gray counts 2, 3, 4 and 5.

$$\begin{aligned} sQ4 &= \overline{Q4} Q5 \overline{Q6} (Q1 + Q3) \\ rQ4 &= Q4 Q5 \overline{Q6} \end{aligned}$$

Q3 counts in gray sequence with the addition of T0 to force the skip of gray counts 2, 3, 4 and 5.

$$\begin{aligned} sQ3 &= \overline{Q3} Q4 \overline{Q5} \overline{Q6} + T0 \\ rQ3 &= Q3 Q4 \overline{Q5} \overline{Q6} \end{aligned}$$

Q2 and Q1 count in a gray sequence but the forced skip of gray counts 2, 3, 4, 5, 15 and 16 simplifies their set and reset expressions.

$$\begin{aligned} sQ2 &= \overline{Q1} \overline{Q5} \overline{Q6} \\ rQ2 &= Q1 \overline{Q4} \overline{Q5} \\ sQ1 &= \overline{Q3} Q5 Q6 \\ rQ1 &= \overline{Q3} \overline{Q4} \overline{Q5} \end{aligned}$$

## PULSE DECODING

Several multiple and single pulse times are decoded from the pulse counter for use in the computer logic:

$$\text{Data word, } \overline{T_p} \overline{T_{24}} = Q_1 + Q_2 + \overline{Q_3}$$

$$\text{Most significant or Sign bit, } T_0 = \overline{Q_1} \overline{Q_2} \overline{Q_3} Q_5$$

$$\text{Least significant bit, } T_{23} = \overline{Q_1} Q_2 \overline{Q_4} \overline{Q_5}$$

$$\text{Guard and first bit of word, } T_{24} = \overline{Q_1} \overline{Q_2} Q_3 \overline{Q_5}$$

$$\text{Guard and last bit of word, } T_p = \overline{Q_1} \overline{Q_2} Q_3 Q_5$$

$$\text{Address field, } (T_{23} - T_{10}) = Q_2$$

$$\text{Indirect address bit, } T_9 = Q_1 \overline{Q_2} Q_3 \overline{Q_4} \overline{Q_5}$$

For additional requirements, the following pulse times are also decoded:

$$(T_{22} - T_{17}) = \overline{Q_1} Q_2 \overline{T_{23}}$$

$$(T_{21} + T_{22}) = \overline{Q_1} Q_2 Q_3 Q_5$$

$$T_{14} = Q_1 Q_2 \overline{Q_3} \overline{Q_5}$$

$$T_{10} = Q_1 Q_2 \overline{Q_4} \overline{Q_5}$$

$$(T_5 - T_0) = \overline{Q_2} \overline{Q_3}$$

$$T_1 = \overline{Q_1} \overline{Q_3} \overline{Q_4} \overline{Q_5}$$

## PHASE CONTROL

The various internal operations, such as transfers of information, clearing registers, read from memory, etc., which must take place during the reading and execution of instructions, are controlled by eight phases, designated phase  $\emptyset 0$  through phase  $\emptyset 7$ . A general description of these eight phases is given below, followed by more detailed discussions on control of the phase sequence by the instruction code.

### PHASES

A phase chart is shown on page 1.19 which indicates the phase sequencing for the various operation codes. Usually, each dot on the diagram represents one cycle time from  $T_p$  until the next  $T_p$ .

#### Phase 0 ( $\emptyset 0$ )

This phase is the beginning of all instructions. Instructions start at  $\emptyset 0 T_{24}$ , with the new instruction in the C register and the instruction register cleared to "NOP" (20).

Indexing and indirect addressing are processed in phase  $\emptyset 0$ . Also, the memory regenerates the instruction (writes it back in memory because of destructive read-out) and fetches the operand. This process may require more than one cycle time, as in the case of indirect addressing, executing and transferring. This phase steps directly to phase  $\emptyset 5$  (at  $\emptyset 0 T_{24}$ ) for some instructions requiring only one cycle time for execution.

At  $\emptyset 0 T_{24}$  the instruction code is transferred to the OP code register (01, 02, 03, 04, 05 06).

#### Phase 1 ( $\emptyset 1$ )

This phase is the set-up or preparation phase for the shift, multiplication and division instructions. Phase 1 inhibits pulsing the memory for an operand.

#### Phase 2 ( $\emptyset 2$ )

This phase is the wait phase for the input/output instructions, (10), (12), (13); (30), (32), (33). The computer waits in this phase until the data is ready. If the data is ready before the instruction is given, then phase  $\emptyset 2$  is by-passed, except for the parallel input/output instructions, (13), (33), where phase  $\emptyset 2$  will last only one cycle time for data to be transferred.

#### Phase 3 ( $\emptyset 3$ )

This phase is the execution phase for shifting, multiplication and division. It usually requires several word times. The duration of this phase in shifting is dependent upon the number of shifts required.

#### Phase 4 ( $\phi_4$ )

This phase is the second cycle time of three-cycle instructions which write data into the memory. These three cycles are  $\phi_0 \rightarrow \phi_4 \rightarrow \phi_7$ . During phase  $\phi_4$  the P register is incremented for accessing the next instruction, and the word to be stored is shifted serially into the C register.

#### Phase 5 ( $\phi_5$ )

This phase is the execution phase for some single-cycle instructions. The C register does not shift and parity is not checked.

#### Phase 6 ( $\phi_6$ )

This phase is the main execution phase of instructions requiring an operand, but no memory modification. These instructions are the two-cycle instructions, and include conditional skips which may require three cycles.

#### Phase 7 ( $\phi_7$ )

During this phase memory regeneration (or new storage) and next instruction access are performed. The P register is not incremented unless the Skip flip-flop is high.

#### End Cycles

An End is defined as the last cycle of execution for the particular instruction being performed. The End term designates that the next phase is to be phase  $\phi_0$  unless the instruction causes a skip.

$$\text{End} = \phi_5 + \phi_6 + \phi_7 + \phi_0 (- - - -)$$

The last term is for unconditional branches.

#### PHASE COUNTER

A three-flip-flop counter, F1, F2 and F3, controls the sequence and advancement of phases:

$$\overline{F1} \overline{F2} \overline{F3} = \phi_0$$

$$\overline{F1} \overline{F2} F3 = \phi_1$$

$$\overline{F1} F2 \overline{F3} = \phi_2$$

$$\overline{F1} F2 F3 = \phi_3$$

$$F1 \overline{F2} \overline{F3} = \phi_4$$

$$F1 \overline{F2} F3 = \phi_5$$

$$F1 F2 \overline{F3} = \phi_6$$

$$F1 F2 F3 = \phi_7$$

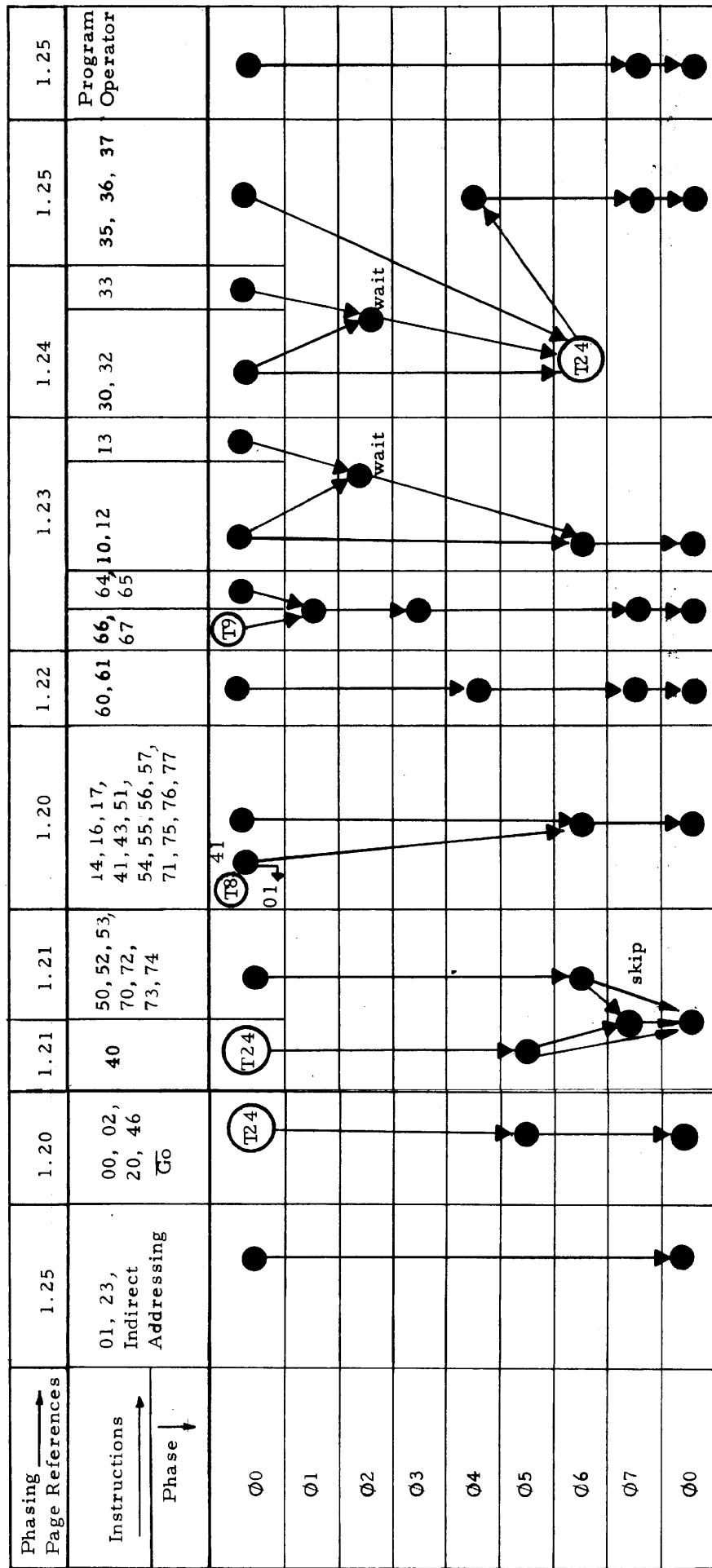
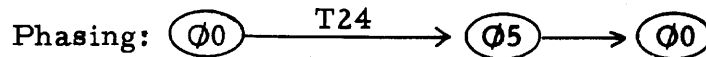

FIGURE 5  
PHASE SEQUENCE CHART

The following discussion indicates the actions of the phase counter during execution of the various instruction groups shown in the phase diagram.

### SINGLE-CYCLE INSTRUCTIONS



Instructions 00, 02, 20 and 46 advance directly to phase  $\emptyset 5$  from phase  $\emptyset 0$ .

$$sF1 = T24 \bar{I}a \emptyset 0 Go \left[ \overline{C5 C8 C2 (C3 + C4)} \right] + - - -$$

$$sF3 = T24 \bar{I}a \emptyset 0 Go \left[ \overline{C5 C8 C2 (C3 + C4)} \right] + - - -$$

The output of the C register flip-flops must be used for the instruction code, as the transfer to the O register is not made until T24.

The  $\bar{I}a$  term represents the indirect address flip-flop and need not be considered for this instruction group. Go is the control term which allows computation.

To reset to phase  $\emptyset 0$ , F1 and F3 are reset at the first Tp,

$$rF1 = Tp \text{ End } \bar{S}k$$

$$rF3 = Tp \text{ End } \bar{S}k$$

where:

$$\text{End} = F1 F3 \bar{T}s + F1 F2 \bar{T}s + - - -$$

Ts is a time-share signal and freezes the internal operation of the computer for two machine cycles while external devices control access to memory. Sk is the flip-flop which signals for a skip condition and need not be considered in this instruction group.

### TWO-CYCLE INSTRUCTIONS

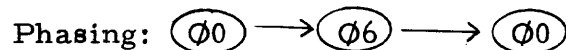

Instructions 14, 16, 17, 41, 43, 51, 54, 55, 56, 57, 71, 75, 76 and 77 advance to phase  $\emptyset 6$  from  $\emptyset 0$  at the first Tp, if there was no indirect addressing.

$$sF1 = Tp \bar{I}a \emptyset 0 03 04 + Tp \bar{I}a \emptyset 0 01 \bar{04} + - - -$$

$$sF2 = Tp \bar{I}a \emptyset 0 03 + Tp \bar{I}a \emptyset 0 01 \bar{02} + - - -$$

If there had been an indirect addressing bit, Ia would be true and phase  $\emptyset 0$  would have been extended one or more additional word times until Ia was reset by the effective address. The computer resets to phase  $\emptyset 0$  at the first Tp of phase  $\emptyset 6$ .

$$rF1 = Tp \text{ End } \bar{S}k$$

$$rF2 = Tp \text{ End } \bar{S}k + - - -$$

### THREE-CYCLE CONDITIONAL SKIP INSTRUCTIONS

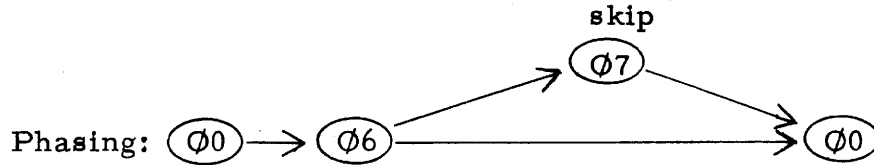

Instructions 50, 52, 53, 70, 72, 73 and 74 advance to phase  $\Phi 6$  at the end of phase  $\Phi 0$ .

$$sF1 = T_p \bar{I}a \Phi 0 01 \bar{0}4 + T_p \bar{I}a \Phi 0 03 04$$

$$sF2 = T_p \bar{I}a \Phi 0 03 + - - -$$

$$rSk = \Phi 0 T0 + - - -$$

These instructions are conditional skip instructions where the Sk (Skip) flip-flop is left in a set condition at the end of phase  $\Phi 6$ , if a skip is to occur. If Sk is true, the phase counter advances to phase  $\Phi 7$ .

$$sF3 = T_p Sk \bar{T}s + - - -$$

Sk will be reset during phase  $\Phi 7$ .

$$rSk = \Phi 7 T0 + - - -$$

If Sk was left in a reset condition at the end of phase  $\Phi 6$ , the phase counter will reset directly to phase  $\Phi 0$ .

$$rF1 = T_p \text{End } \bar{S}k$$

$$rF2 = T_p \text{End } \bar{S}k + - - -$$

$$rF3 = T_p \text{End } \bar{S}k$$

Note that phase  $\Phi 6$  and  $\Phi 7$  are both end cycle phases, and if a skip occurs, End will be true for two cycles. The conditions under which Sk is set during phase  $\Phi 6$  are discussed in the material on "Skip and Branch Instructions".

### TWO-CYCLE CONDITIONAL SKIP INSTRUCTIONS

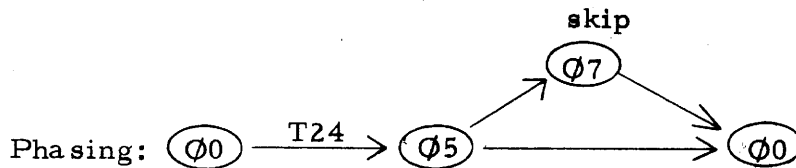

Instruction 40 advances directly to phase  $\Phi 5$  at  $\Phi 0 T24$ .

$$sF1 = T24 \bar{I}a \Phi 0 \text{Go } \left[ \bar{C}5 \bar{C}8 \bar{C}2 (\bar{C}3 + \bar{C}4) \right] + - - -$$

$$sF3 = T24 \bar{I}a \Phi 0 \text{Go } \left[ \bar{C}5 \bar{C}8 \bar{C}2 (\bar{C}3 + \bar{C}4) \right] + - - -$$

This phase advancement is identical to the single-cycle operation discussed under Phase Control.

During phase  $\Phi 5$ , instruction 40 tests to see if M (external signal) is in a true or false condition. If the signal is false, then the Sk (Skip) flip-flop will be set and a skip will occur.



$$sSk = T0 \overline{\phi 5} 01 \overline{04} \text{ (external signal) } + - - -$$

If  $Sk$  is set at  $T0$ , then the phase counter advances to phase  $\phi 7$  at  $Tp$  to perform the skip.

$$sF2 = Tp \overline{Ts} Sk - - - + - - -$$

At the completion of phase  $\phi 7$ , or at the completion of phase  $\phi 5$ , (if the skip condition were false and  $Sk$  was not set) the phase counter is reset to phase  $\phi 0$ .

$$rF1 = Tp \text{ End } \overline{Sk}$$

$$rF2 = Tp \text{ End } \overline{Sk} + - - -$$

$$rF3 = Tp \text{ End } \overline{Sk}$$

$Sk$  is reset during phase  $\phi 7$ .

$$rSk = \phi 7 T0 + - - -$$

Note that phases  $\phi 5$  and  $\phi 7$  are both end-cycle phases, and if a skip occurs, **End** will be true for two cycles.

### THREE-CYCLE MEMORY INCREMENT OR DECREMENT INSTRUCTIONS

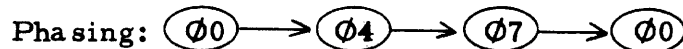

Instructions 60 and 61 advance to phase  $\phi 4$  at the completion of phase  $\phi 0$ . During  $\phi 0$  indexing or indirect addressing may have been performed.

$$sF1 = Tp \overline{Ia} \phi 0 01 \overline{04} + - - -$$

At the completion of phase  $\phi 4$  (one cycle), during which the contents of memory are decremented for 60 or incremented for 61, the phase counter is advanced to phase  $\phi 7$ .

$$sF2 = Tp \overline{Ts} \phi 4 + - - -$$

$$sF3 = Tp \overline{Ts} \phi 4 + - - -$$

If during  $\phi 4$  of a 60 instruction  $C$  is negative,  $Sk$  will be set causing a skip to occur during  $\phi 7$ . During phase  $\phi 7$  the modified number is stored in memory and the next instruction is accessed. At the completion of phase  $\phi 7$  the counter is reset to phase  $\phi 0$ .

$$rF1 = Tp \text{ End } \overline{Sk}$$

$$rF2 = Tp \text{ End } \overline{Sk} + - - -$$

$$rF3 = Tp \text{ End } \overline{Sk}$$

## MULTIPLICATION AND DIVISION INSTRUCTIONS



Instructions 64 and 65 require four phases. Each phase has a duration of one cycle time in multiplication. In division, phase  $\emptyset 3$  lasts 25 cycles ( $\emptyset 3 \overline{S8}$  for 24 cycles,  $\emptyset 3 S8$  for one cycle).  $F3$  is set at  $\emptyset 0 T_p$  to form  $\emptyset 1$ .

$$sF3 = T_p \overline{Ia} \emptyset 0 \overline{02} \overline{03} \overline{04} + \dots$$

At the following  $T_p$  the phase counter progresses to  $\emptyset 3$ .

$$sF2 = \emptyset 1 T_p + \dots$$

During  $\emptyset 3$  the  $S_k$  flip-flop is set to force  $\emptyset 7$ .

$$sSk = \emptyset 3 \overline{05} \overline{06} T_{24} \quad (64)$$

$$+ \emptyset 3 T_0 S8 \quad (65)$$

+ - - -

$$sF1 = T_p \overline{Ts} S_k + \dots$$

Instruction 65 requires  $S8$  to be set before  $S_k$  is set.  $S8$  is set after 24 cycles that are counted in flip-flops  $S9$  through  $S13$ .

$$\text{Count } S = S_s = \emptyset 3 T_{23} \overline{Mh}$$

$$sS8 = \overline{F1} F3 \overline{Ts} T_p \overline{S9} \overline{S10} \overline{S11} \overline{S12} \overline{S13} (\overline{04} \overline{05} \overline{06})$$

+ - - -

The  $P$  register is incremented in phase  $\emptyset 7$  since  $S_k$  is set.

$$sIa = T_{24} \emptyset 7 S_k + \dots$$

## N-CYCLE SHIFT INSTRUCTIONS

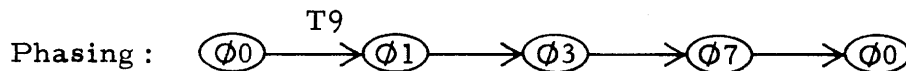

Instructions 66 and 67 terminate phase  $\emptyset 0$  at pulse time  $T_9$  to advance to phase  $\emptyset 1$  for pulse times  $T_8$  through  $T_p$ .

$$sF3 = T_9 \overline{Ia} \emptyset 0 \overline{02} \overline{03} \overline{04} \overline{05} + \dots$$

During phase  $\emptyset 1$  (10 pulse times) the registers and shift counter are prepared for shifting. At  $T_p$  the counter advances to phase  $\emptyset 3$ .

$$sF2 = T_p \emptyset 1 + \dots$$

The shift operation occurs during phase  $\emptyset 3$  and is terminated when the  $S_k$  flip-flop is set, indicating that the shift counter has reached zero or that a normalized condition exists. Upon termination, the phase counter advances to phase  $\emptyset 7$  from phase  $\emptyset 3$  (or phase  $\emptyset 1$  if the shift count was originally zero).

$$sF1 = T_p S_k \overline{T_s} + - - -$$

$$sF2 = T_p S_k \overline{T_s} + - - -$$

During phase  $\phi_7$  the next instruction is accessed and at  $T_p$  the counter is reset to phase  $\phi_0$ .

$$rF1 = T_p \text{ End } \overline{S_k}$$

$$rF2 = T_p \text{ End } \overline{S_k} + - - -$$

$$rF3 = T_p \text{ End } \overline{S_k}$$

### THREE-CYCLE PLUS N OUTPUT INSTRUCTIONS

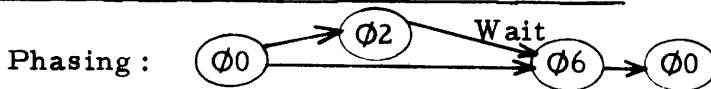

Instructions 10, 12 and 13 are output instructions which are interlocked with a flip-flop designated  $R_f$ , which indicates when the external device is "ready" for output. Instructions 10 and 12 advance the counter to phase  $\phi_6$ , if  $R_f$  is set during phase  $\phi_0$ .

$$sF1 = T_p \overline{T_s} \overline{01} \overline{03} \overline{04} \overline{I_a} \overline{F1} \overline{F3} R_f + - - -$$

$$sF2 = T_p \overline{I_a} \phi_0 \overline{03} + - - -$$

If  $R_f$  was not set, the counter is advanced to phase  $\phi_2$  (a wait phase).

$$sF2 = T_p \overline{I_a} \phi_0 \overline{03} + - - -$$

Instruction 13 always advances the counter to phase  $\phi_2$  for at least one cycle time.

When  $R_f$  is set during phase  $\phi_2$  the counter advances to phase  $\phi_6$ .

$$sF1 = T_p \overline{T_s} \overline{01} \overline{03} \overline{04} \overline{I_a} \overline{F1} \overline{F3} R_f + - - -$$

At the completion of phase  $\phi_6$ , during which output was executed, the counter is reset to phase  $\phi_0$ .

$$rF1 = T_p \text{ End } \overline{S_k}$$

$$rF2 = T_p \text{ End } \overline{S_k} + - - -$$

$$rF3 = T_p \text{ End } \overline{S_k}$$

$$rR_f = T_p \text{ End } \overline{S_k}$$

### FOUR-CYCLE PLUS N INPUT INSTRUCTIONS

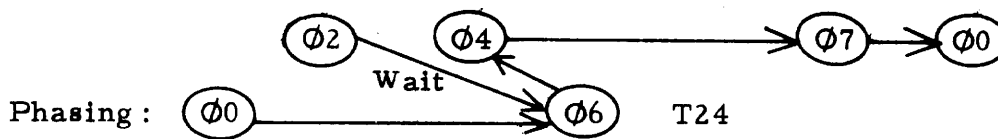

Instructions 30, 32 and 33 are input instructions which are interlocked with the Rf (Ready) flip-flop.

If Rf is not set during phase  $\Phi 0$ , the counter advances to phase  $\Phi 2$ .

$$sF2 = T_p \bar{I}_a \Phi 0 03 + - - -$$

Instruction 33 always advances the counter to phase  $\Phi 2$ . When Rf is set during phase  $\Phi 2$ , or if Rf was set during phase  $\Phi 0$ , the counter advances to phase  $\Phi 6$ .

$$sF1 = T_p \bar{T}_s \bar{01} 03 \bar{04} \bar{I}_a \bar{F1} \bar{F3} Rf + - - -$$

$$sF2 = T_p I_a \Phi 0 03 + - - -$$

The counter remains in phase  $\Phi 6$  for one pulse time (T24) and is reset to phase  $\Phi 4$  where the input is executed.

$$rF2 = \Phi 6 \bar{01} 02 03 T24 + - - -$$

At the completion of phase  $\Phi 4$  the counter is set to phase  $\Phi 7$ .

$$sF2 = T_p \bar{T}_s \Phi 4 + - - -$$

$$sF3 = T_p \bar{T}_s \Phi 4 + - - -$$

At the completion of phase  $\Phi 7$  the counter is reset to phase  $\Phi 0$  and Rf is reset.

$$rRf = T_p \text{End } \bar{S}_k$$

### THREE-CYCLE STORE INSTRUCTIONS

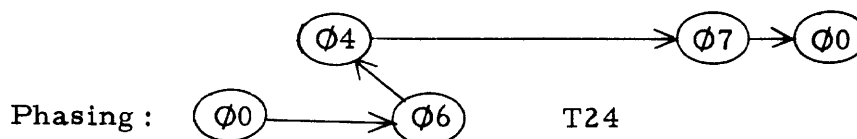

Instructions 35, 36 and 37 advance to phase  $\Phi 6$  at the completion of phase  $\Phi 0$ .

$$sF1 = T_p \bar{I}_a \Phi 0 03 04 + - - -$$

$$sF2 = T_p \bar{I}_a \Phi 0 03 + - - -$$

$$rF2 = T24 \Phi 6 \bar{01} 02 03 + - - -$$

After one pulse time in phase  $\Phi 6$  the counter is reset to phase  $\Phi 4$  where the information is shifted to the C register for storage. At the completion of phase  $\Phi 4$  the counter advances to phase  $\Phi 7$ .

$$sF2 = T_p \bar{T}_s \Phi 4 + - - -$$

$$sF3 = T_p \bar{T}_s \Phi 4 + - - -$$

During phase  $\phi 7$  the data is stored in memory and the next command is accessed. At the completion of phase  $\phi 7$  the counter is reset to phase  $\phi 0$ .

$$\begin{aligned} rF1 &= T_p \text{ End } \overline{S_k} \\ rF2 &= T_p \text{ End } \overline{S_k} + \dots \\ rF3 &= T_p \text{ End } \overline{S_k} \end{aligned}$$

### ONE-CYCLE UNCONDITIONAL BRANCH INSTRUCTIONS



The 01 (Unconditional Branch) and 23 (Execute) instructions occur within phase  $\phi 0$ , and there is no change in the phase counter. A similar operation occurs when there is an indirect address bit in the instruction and phase  $\phi 0$  is extended as a new address is read from memory.

### PROGRAM OPERATOR INSTRUCTIONS

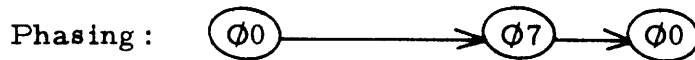

All instructions affected by the program operator bit act as follows:

The program operator bit acts as the instruction code and the counter is advanced to phase  $\phi 7$ .

$$\begin{aligned} sF1 &= T_p \overline{T_s} P_0 \dots + \dots \\ sF2 &= T_p \overline{T_s} P_0 \dots + \dots \\ sF3 &= T_p \overline{T_s} P_0 \dots + \dots \end{aligned}$$

During phase  $\phi 7$  the program operator bit and the instruction code are combined as an entry address to a subroutine and are transferred to the P register, which contains the address of the next instruction to be accessed. At the completion of phase  $\phi 7$  the phase counter is reset to phase  $\phi 0$ .

$$\begin{aligned} rF1 &= T_p \text{ End } \overline{S_k} \\ rF2 &= T_p \text{ End } \overline{S_k} + \dots \\ rF3 &= T_p \text{ End } \overline{S_k} \end{aligned}$$

## REGISTERS

There are nine registers in the SDS 920 Computer. These registers are implemented in three different methods. The S, M and O registers use the usual RS-type flip-flops. The P and C registers use flip-flops designated as "repeaters." These flip-flops will automatically reset, if there is no set input. However, these flip-flops will not set or reset unless they receive an "enable" signal.

The A, B, X and Word Assembly registers are one-word recirculating registers using dynamic, serial, shift circuits with repeater flip-flops at the "read and write" ends. To hold information, these registers must constantly circulate in a fashion similar to delay lines.

The first or "write" flip-flop (repeater) of the register is designated "w", i.e., Aw, and the last flip-flop, which may or may not be driven by an intermediate "read" flip-flop, is designated by an "n", i.e., An, which means "now". The "read" flip-flop is designated by "r", i.e., Ar.

During normal recirculation the output of the "n" (now) flip-flop is fed to the "w" (write) flip-flop which, in turn, feeds the dynamic register stages. The output of the last register stage either feeds the "n" (now) flip-flop directly or feeds an intermediate "r" (read) flip-flop which, in turn, feeds the "n" (now) flip-flop. In this case, the number of dynamic stages would be reduced by one to allow for the added delay of the "read" flip-flop. In the 920 a flip-flop Ae (early) is between Ar and An.

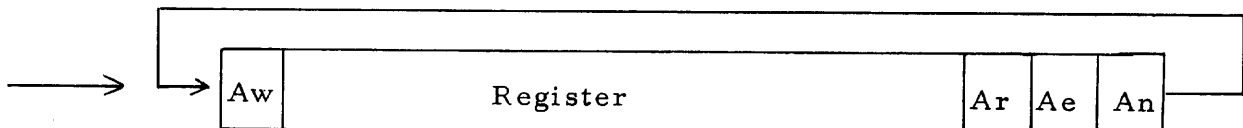

When writing into these recirculating registers a "not recirculate" term is enabled for the register involved, i.e., Anr (A register not recirculated).

### P REGISTER

#### Function:

The P register is the program counter. It contains the location from which the instruction was taken. It is increased by one, just preceding the time when the memory must be addressed for the next instruction. Since it must transfer its contents to the S (address) register in parallel, in order to keep the memory going at full rate, it is composed of 14 repeater flip-flops. These flip-flops are the repeater type since P is basically a shifting register. It is incremented by ring-shifting right for one complete revolution using the Ia flip-flop as a carry in a half adder.

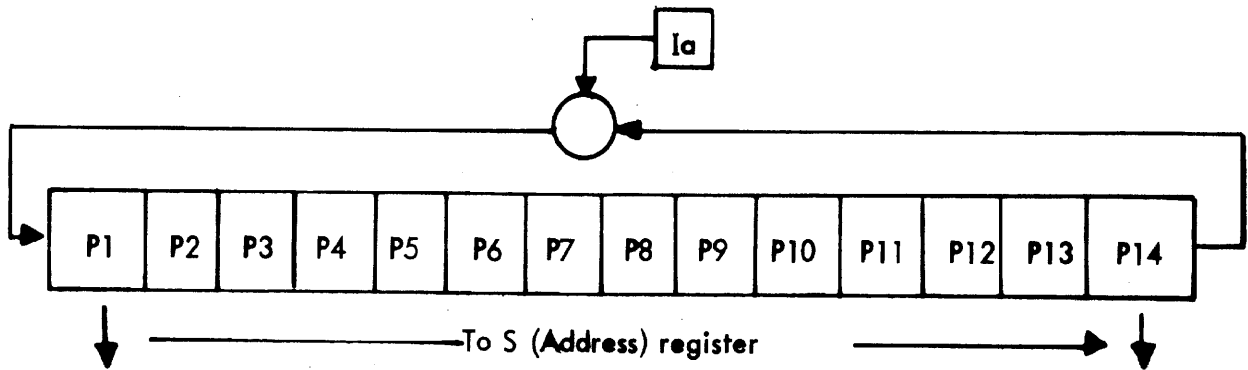

**Implementation:**

14 repeater flip-flops

**Control Terms:**

The P register is enabled by Pg. The P register recirculates during pulse times T23 through T10 and for phases  $\phi_4$ ,  $\phi_5$ ,  $\phi_6$  and  $\phi_7$ , and increments by one during phases  $\phi_4$ ,  $\phi_5$  and  $\phi_6$ , and sometimes during phase  $\phi_7$ .

$$Pg = Q2 \bar{T}_3 Go F1 - - - + - - -$$

For certain instruction codes incrementing will occur during phase  $\phi_7$ . Incrementing is performed using the Ia (Indirect Address) flip-flop as a carry in a half adder.

$$sIa = T24 F1 \bar{F}_3 \textcircled{1} + \bar{C}_2 \bar{C}_3 \bar{C}_8 (\bar{C}_3 + \bar{C}_4) \phi_0 \bar{Ia} T24 Go + T24 \phi_7 Sk + - - -$$

$$rIa = \bar{P14} F1 \bar{T24} - - - + T0 F1 + - - -$$

The sum is implemented on setting P1.

$$sP1 = \bar{Ia} P14 F1 - - - + Ia \bar{P14} F1 - - - + - - -$$

The P register is always loaded serially. The new instruction address is transferred to the S (Address) register at pulse time T9 of each End cycle.

$$Sxp = T9 \bar{Int} End + - - -$$

**S REGISTER**

**Function:**

The S register holds the address of the memory location to be accessed. It must remain in a static state when memory is actively reading or writing. The S register receives its address information in parallel from the P register, the C register (the address field of the instruction is in the C register), or from the interrupt address lines.

The S register does not shift and only receives information.

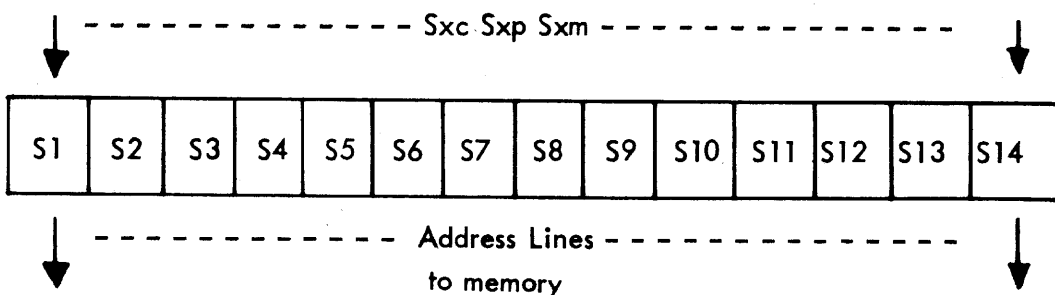

Implementation:

14 RS flip-flops

Control Terms:

The S register is reset or cleared by Sc just prior to receiving the address of the next instruction (T10 End), or the address of the operand (T10 00).

$$Sc = T10 (End + \overline{Ts} \overline{F1} \overline{F2}) + - - -$$

At T9 the S register receives the address of the next instruction from the P register.

$$Sxp = T9 \overline{Int} End + 00 \text{ (Branch Commands)}$$

During phase 00 the S register receives the address of the operand from the C register which now contains the instruction.

$$Sxc = T9 00 \overline{P0} \text{ (Ia + 03 + 02)}$$

During the "interrupt" operation the S register receives its address from external address lines designated "N", where "Int" is the Interrupt signal.

$$Sxn = T9 Int \overline{Ts}$$

The S register does not control the memory during shift instructions, multiplication and division. Instead, the individual S register flip-flops aid in the execution of those instructions. The basic equations for the S flip-flops are:

$$\begin{array}{l}
sS1 = C0 Sxc + P1 Sxp + - - - \\
rS1 = Sc + - - - \\
| \\
| \\
sS5 = C4 Sxc + P5 Sxp + N5 Sxn + - - - \\
rS5 = Sc + - - - \\
| \\
| \\
sS14 = C13 Sxc + P14 Sxp + N14 Sxn + - - - \\
rS14 = Sc + - - -
\end{array}$$

M REGISTER

Function:

The M register is the Read-Write register for the core memory. It receives the information from memory during a read process and holds the information for storing in memory during a write process.



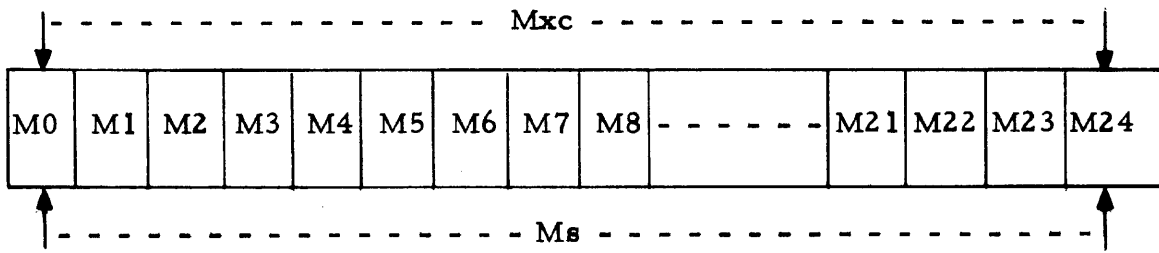

Implementation:

25 RS flip-flops

Control Terms:

The M register is cleared or reset by Mc just prior to receiving information to be stored or just prior to receiving information from memory. Mc also acts as the pulse which signals memory to start a read-write cycle.

Prior to writing new data:

$$M_c = T_p P_0 + T_p \overline{\phi_4} + T_p \overline{\phi_2} \overline{\phi_3} \phi_5 \phi_0 \overline{I_a} + \dots$$

Prior to reading:

$$M_c = Q_1 \overline{Q_2} Q_3 \overline{Q_4} Q_5 (F_1 + \overline{F_3} + T_s) (T_{sm} + \overline{T_s}) + \dots$$

Note that the above pulse time is T8 and phases are  $\phi_0, \phi_2, \phi_4, \phi_5, \phi_6, \phi_7$ , excluding phases  $\phi_1$  and  $\phi_3$ .

The contents of the C register are transferred to M for storage at T24, when writing new data into memory.

$$M_{xc} = T_{24} P_0$$

In this case, P0 is time-shared and remembers that the data in C is to be stored.

The equations for the M flip-flops are:

$$sM_0 = M_{d0} M_s + M_{xc} C_0$$

$$rM_0 = M_c$$



$$sM_{24} = M_{d24} M_s + M_{xc} C_{24}$$

$$rM_{24} = M_c$$

Ms is the strobe pulse which loads the M register from memory, and Md0 - Md24 represent the data signals from memory.

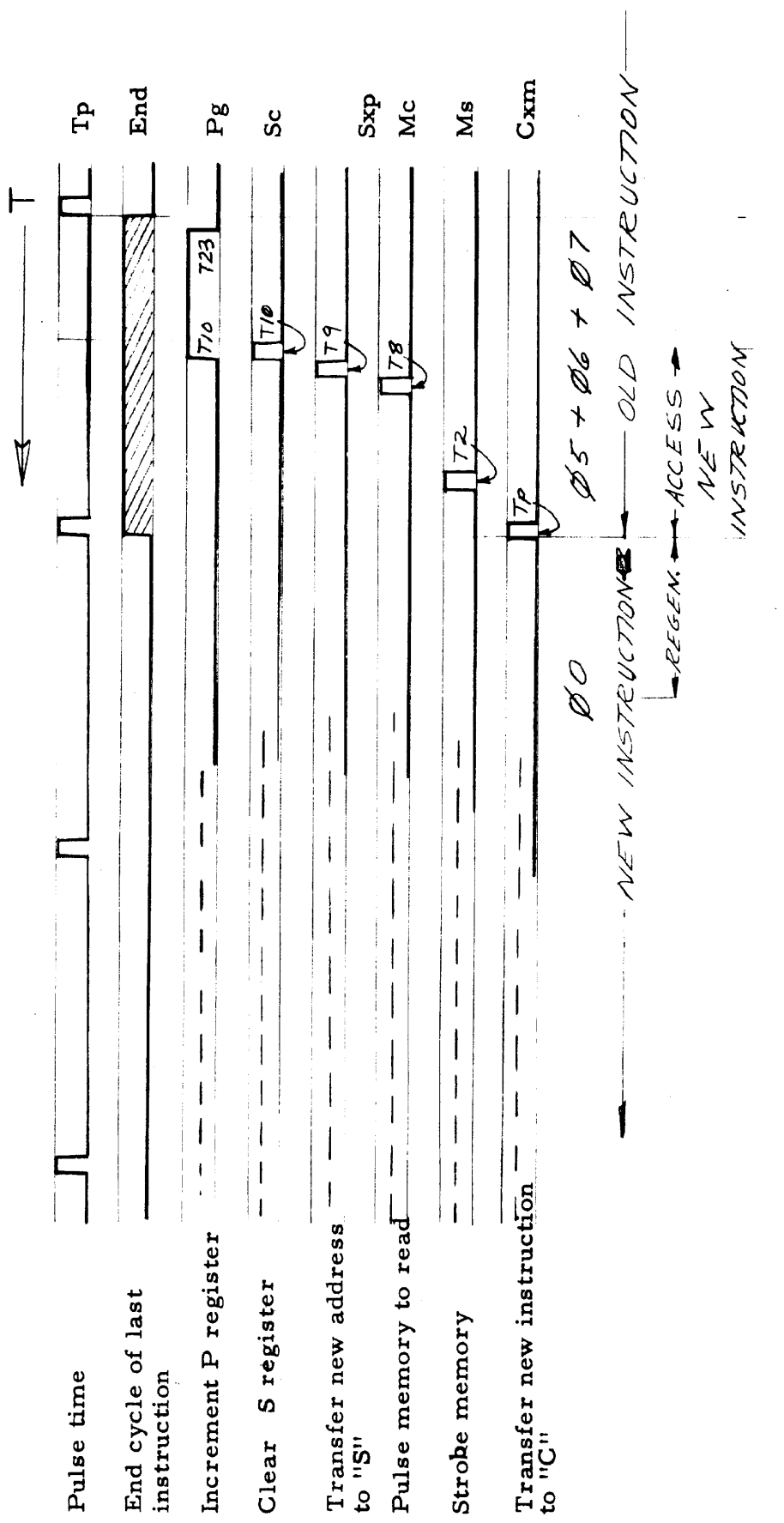
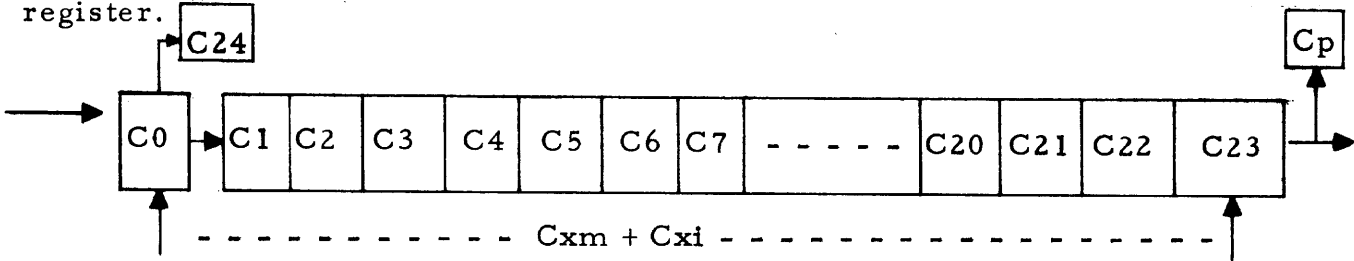

FIGURE 6  
ACCESSING AN INSTRUCTION

## C REGISTER

### Function:

The C register acts as a central transfer station for all information going to and from memory. During certain arithmetic operations C acts as an arithmetic register.



### Implementation:

24 repeater and 2 RS flip-flops.

### Control Terms:

The C register receives information in parallel from the M register. Instructions are transferred to the C register at  $T_p$  time of an End cycle.

$$C_{xm} = T_p \text{ End Go} + \dots$$

Operands are transferred to C from M during phase  $\phi_0$  with the exception of instructions 40, 41, 43, 46, which are branch, skip, or register change instructions.

$$C_{xm} = T_p \overline{\phi_0} \overline{\phi_0} [\overline{\phi_0} \overline{Ia} \overline{\phi_2} \overline{\phi_3} \overline{\phi_1}] + \dots$$

For instruction 33 the C register receives its information in parallel from external signals.

$$C_{xi} = \phi_2 \phi_2 \phi_6$$

The C register is shifted to the right by a term designated  $C_s$ .  $C_s$  shifts to the right during phases  $\phi_0$ ,  $\phi_1$ ,  $\phi_4$  and  $\phi_6$ ; it also shifts to the right during exchange of registers and time-share, which are discussed in their respective sections.

$$C_s = \overline{T_p} \overline{T_{24}} F_1 \overline{F_3} + \overline{T_p} \overline{T_{24}} \overline{F_1} \overline{F_2} + \dots$$

Since repeater flip-flops are used in the C register, it is "enabled" to receive information by a term designated  $C_g$ .

$$C_g = C_s' \overline{T_p} \overline{T_{24}} + C_{xm}' T_p + C_{xi} Q_1 + \dots$$

Some of the basic equations for the C register flip-flops are:

$$sC_0 = C_{xm} M_0 + C_{xi} C_{d0} + \textcircled{Kc_0}$$

$$+ \dots + \dots$$

(NOTE: Other  $C_0$  inputs are described in Instruction explanations.)

$$sC1 = C_s C0 + C_{xm} M1 + C_{xi} Cd1 + (Kc1)$$

$$sC23 = C_s C22 + C_{xm} M23 + C_{xi} Cd23 + (Kc23)$$

(Kci) is the Ci manual set button on the control panel.

## O REGISTER

### Function:

The O register usually contains the 6-bit instruction code during the execution of the instruction. This register does not shift and only receives information.

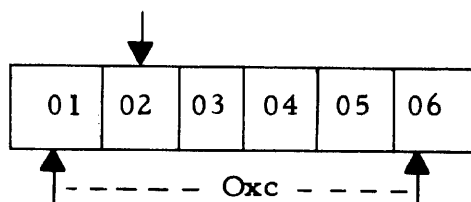

### Implementation:

6 RS flip-flops.

### Control Terms:

The O register is cleared or reset by a term designated Oc at the end of each End cycle and at the end of phase  $\emptyset 0$  for Instruction 23.

$$Oc = T_p \text{ End } \overline{Sk} + \overline{01} \overline{03} \overline{05} T_p \overline{Ia} + \dots$$

The O register is always reset to a (20) by setting 02 and resetting 01, 03, 04, 05 and 06,

The O register receives the instruction code from the C register at T24 of  $\emptyset 0$ .

$$Oxc = T_{24} \emptyset 0 \text{ Go } \overline{Ia} \overline{C2}$$

In this equation C2 represents the P0. (program operator) bit, in which case the instruction code would remain a (20).

The basic equations for the O register flip-flops are:

$s01 = Oxc C3$	$s04 = Oxc C6$
$r01 = Oc$	$r04 = Oc$
$s02 = Oc$	$s05 = Oxc C7$
$r02 = Oxc \overline{C4}$	$r05 = Oc$
$s03 = Oxc C5$	$s06 = Oxc C8$
$r03 = Oc$	$r06 = Oc$

## A REGISTER

### Function:

The A register is the accumulator for the computer and is employed in all arithmetic, logical and shifting operations.

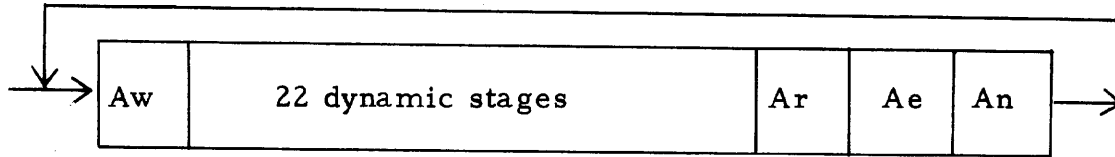

### Implementation:

The write flip-flop (repeater) is followed by 22 stages of dynamic relay. The "early" flip-flop (Ae) and the "now" flip-flop (An) are both RS flip-flops. The "read" circulation in the Aw and Ar flip-flops are always enabled. The A register is exactly 26 bits in length and must recirculate to maintain internally stored information as in a delay line.

### Control Terms:

The Ae flip-flop always reads Ar except when S8 is reset during right shift instructions.

$$\begin{aligned} sAe &= Ar \left[ (\overline{\phi 3 05 06}) (Q1 + Q2 + S8 \overline{Q3}) \right] + Ar S8 \\ rAe &= \overline{Ar} \left[ (\overline{\phi 3 05 06}) (Q1 + Q2 + S8 \overline{Q3}) \right] + \overline{Ar} S8 \end{aligned}$$

The An flip-flop reads Ae except during right shift.

$$\begin{aligned} sAn &= Ae \left[ (\overline{\phi 3 05 06}) (Q1 + Q2 + S8 \overline{Q3}) \right] \\ rAn &= \overline{Ae} \left[ (\overline{\phi 3 05 06}) (Q1 + Q2 + S8 \overline{Q3}) \right] \end{aligned}$$

The recirculation of the A register is inhibited by Anr (A not recirculate). The recirculation of the A register is blocked during the execution ( $\phi 6$ ) of logical instructions and Add and Subtract instructions.

$$Anr = \overline{02 03 04 \phi 6} + - - -$$

It is inhibited during the loading of A from memory (76).

$$Anr = 01 02 03 04 05 \overline{06} \phi 6 + - - -$$

It is inhibited during the register change (46) when applicable.

$$Anr = \overline{02 03 04 Ts} (C23 + C20 + C16) + - - -$$

It is also inhibited during Multiply (64), Divide (65), Right Shift (66) and Left Shift (67).

$$Anr = \phi 3 + - - -$$

The basic recirculation equation is:

$$sAw = \overline{Anr An Tp} + - - -$$

Ar is fed from the last dynamic stage of the A register.

## B REGISTER

### Function:

The B register acts as an extension of the least significant end of the A register for double precision operations and for shift operations. The B register holds operands for the multiply (64) and divide instructions (65).

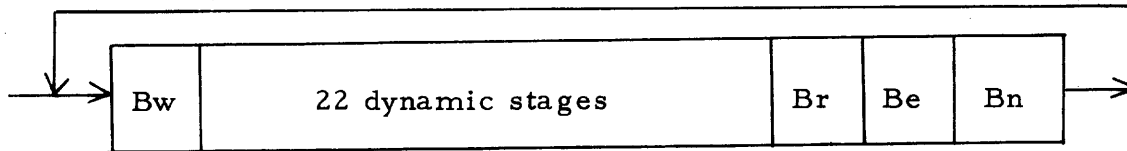

### Implementation:

The B register is implemented in the same manner as the A register.

### Control Terms:

The recirculation of the B register is inhibited by Bnr (B not recirculate). The contents of the B register are inhibited during the loading of B from memory (75).

$$Bnr = 01\ 02\ 03\ 04\ \overline{05}\ 06\ \emptyset6 + \dots$$

It is inhibited during the register change instruction (46) when applicable.

$$Bnr = \overline{02}\ \overline{03}\ 04\ \overline{T_s} (C22 + C21 + C18) + \dots$$

It is also inhibited during shift (66, 67) and Multiply, Divide (64, 65) instructions.

$$Bnr = \emptyset3 + \dots$$

The basic recirculation equation for the B register is shown below. Additional input terms are described under instructions.

$$sBw = \overline{Bnr}\ Bn + \dots$$

## X REGISTER

### Function:

The X register is the Index register. The least significant 14 bits will be added to the address of the instruction before execution if there is an index tag in position T1 of the instruction. Indexing takes place during phase  $\emptyset0$  and is discussed in detail under Indexing.

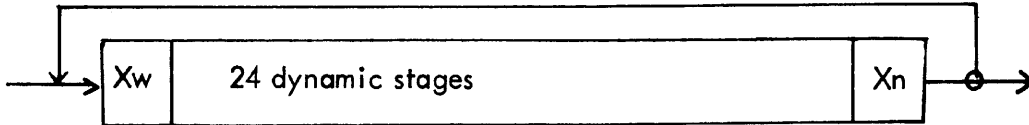

**Implementation:**

The Xw flip-flop (repeater) is followed by 24 stages of dynamic delay and the last dynamic stage feeds the Xn (now) repeater.

**Control Signals:**

The Xw and Xn repeaters are always enabled to maintain recirculation. Recirculation of the X register is inhibited by Xnr (X not recirculate) during certain instructions.

Recirculation is inhibited during the loading of X from memory (71),

$$Xnr = 01\ 02\ 03\ \overline{04}\ \overline{05}\ 06\ \emptyset 6\ +\ -\ -\ -$$

Increment X and branch (41),

$$Xnr = \emptyset 0\ 01\ \overline{02}\ \overline{03}\ \overline{05}\ I_a\ +\ -\ -\ -$$

and during normalize (67) and copy effective address to X (77),

$$Xnr = \emptyset 3\ 06\ S_2\ +\ 01\ 02\ 03\ 04\ 05\ 06\ \overline{I_a}\ \emptyset 0\ Q_2$$

S2 is time-shared during normalize. The basic recirculation term for the X register is:

$$sXw = \overline{Xnr}\ Xn\ +\ -\ -\ -$$

**WORD ASSEMBLY REGISTER (WAR)**

**Function:**

The WAR is part of the Buffer System and is described in detail in the W Buffer section. Its basic function is to hold information on input and output.

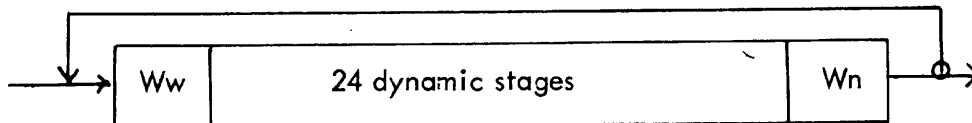

Implementation:

The WAR is implemented in the same manner as the X register.

Control Terms:

Refer to the W Buffer Section.



## MEMORY CONTROL

The computer generates the basic timing signals used by the core memory.

The M (memory) register receives the information in parallel from the sense amplifiers during reading and controls the Z inhibit lines to the core memory during writing.

The memory cycle is out of phase with the computer cycle. Reading is started at T7 and the word read is strobed into the M register at T2, so that the word is ready for the computer to use before T<sub>p</sub>. The memory write cycle is performed during the first part of the computer cycle, from T21 through T11.

The address that controls the memory is usually set up in the computer S register. This register is cleared at T10 time and loaded in parallel at T9 time from the C or P registers. At T8 the Mc signal clears the M register and starts the memory cycle. The memory is cycled every computer cycle, except when the computer is in phase Ø1 or Ø3 for shift, multiplication and division instructions, and except during the second cycle of a time-share interlace operation.

$$M_c = Q_1 \overline{Q_2} Q_3 \overline{Q_4} Q_5 (F_1 + \overline{F_3} + T_s) (T_{sm} + \overline{T_s})$$

where:

$$Q_1 \overline{Q_2} Q_3 \overline{Q_4} Q_5 = T_8$$

This signal (M<sub>c</sub>) clears the M register. It also sets M<sub>g</sub>, the flip-flop that gates all timing signals to the memory.

$$sM_g = M_c Q_1 \textcircled{Me} \overline{St}$$

$$rM_g = Q_1 Q_2 Q_3 \overline{Q_4} M_g = T_{11}$$

The  $\textcircled{Me}$  signal is a signal from the automatic "start-up, shut-down" relays and it is normally true.

The read timing signal is true from T7 through T0.

$$M_{rt} = M_g \overline{Q_2} (\overline{Q_3} + Q_4)$$

The contents of the addressed memory cell are strobed into the M register at T2 by M<sub>s</sub>.

$$M_s = M_g (T_5 - T_0) Q_1 \overline{Q_4} \overline{Q_5}$$

$$sM_0 = M_s M_{d0} + \dots$$

$$sM_{24} = M_s M_{d24} + \dots$$

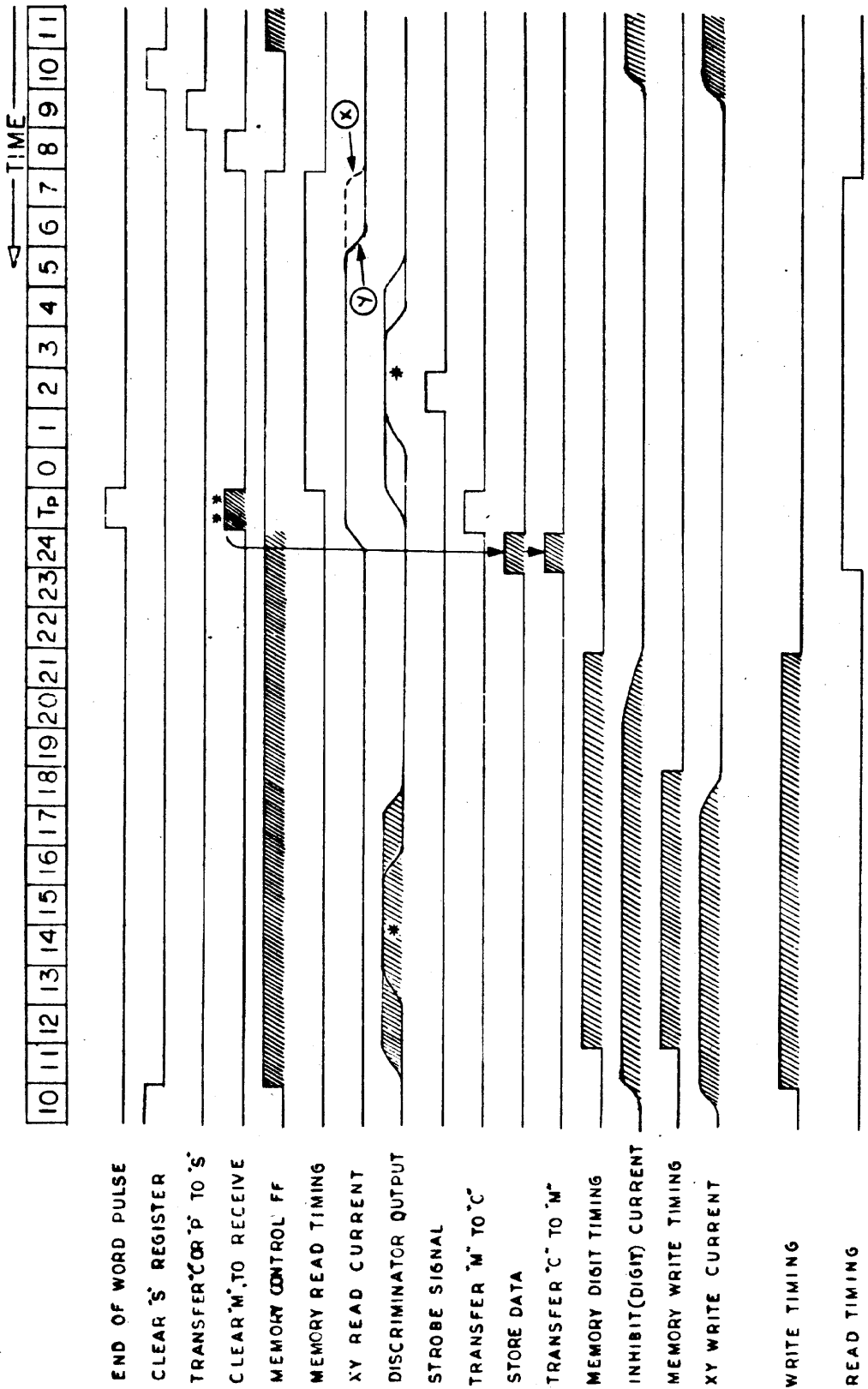

\* PULSE WIDTH MAY VARY.

\*\* ONLY IF DIFFERENT DATA IS TO BE STORED IN THAT ADDRESS.

TIME

FIGURE 7  
COMPUTER MEMORY CYCLE

If the M (memory) register is to be copied in parallel to the C register, it is done at  $T_p$  by  $C_{xm}$ . The contents of the M register are then regenerated (written back) into memory. If new information is to be stored in memory, then the M register is cleared at  $T_p$  by  $M_c$ .

This sets the P0 flip-flop, if it was not already set. P0 then remembers to transfer the contents of C to M at the following  $T_{24}$  time for storage.

$$sP0 = M_c T_p$$

$$rP0 = T_{24} P0$$

$$M_{xc} = T_{24} P0$$

The write timing signal to the memory is true from  $T_{18}$  through  $T_{12}$ .

$$M_{wt} = M_g Q_2 (Q_1 M_{dt} + \overline{Q_3} Q_5)$$

The two terms in the OR gate overlap in time so that there is no cross-over voltage spike.

The digit timing pulse supplied to the memory is true from  $T_{21}$  through  $T_{12}$ .

$$M_{dt} = M_g Q_2 (\overline{Q_3} + Q_4)$$

Two signals control the direction of the current through the cores, as the current must be reversed between the "Read" and "Write" periods.

$$R_w = \overline{Q_2} M_g$$

$$W_r = (Q_2 M_g) (M_{dt} + Q_1)$$

## ADDER

The adder is a full adder composed of the Xz (augend) input, the Yz (addend) input and the Cz carry flip-flop. It is completely serial and there is no "logical" delay through the adder.

The Yz input always delivers the word from memory. The adder is used in many instructions and during indexing. The basic equations are shown below. The adder is discussed in additional detail under Instructions and Indexing.

$$\begin{aligned} \text{Add} &= X_z Y_z C_z + X_z \overline{Y_z} \overline{C_z} \\ &+ \overline{X_z} Y_x \overline{C_z} + \overline{X_z} \overline{Y_z} C_z \end{aligned}$$

$$\begin{aligned} \overline{\text{Add}} &= \overline{X_z} \overline{Y_z} \overline{C_z} + \overline{X_z} Y_z C_z \\ &+ X_z \overline{Y_z} C_z + X_z Y_z \overline{C_z} \end{aligned}$$

## INSTRUCTION OPERATORS

### INDEX OPERATION

All instructions begin at  $\phi_0$  T24 with the instruction in the C register. During phase  $\phi_0$  the C register is shifted right, through the adder, and back to itself.

#### Shift C register:

$$Cs = \overline{T_p} \overline{T_{24}} \overline{F_1} \overline{F_2} + \dots$$

As it is shifted right, through the adder, it enters through Yz.

$$Yz = C_{23} \overline{F_1} \overline{F_3} + \dots$$

The carry flip-flop Cz starts in a reset condition.

$$rCz = \phi_0 \overline{I_x} \overline{T_p} + \dots$$

If there is an index bit in C1 at  $\phi_0$  T24, the Index flip-flop will be set.

$$sI_x = T_{24} \phi_0 C_1 + \dots$$

It is reset at the end of phase  $\phi_0$ .

$$rI_x = T_p \overline{M_h} + \dots \quad (\overline{M_h} \text{ is true except during the execution of the multiply instruction})$$

During the addition the Index register (X) is selected by Xz (augend input), if Ix is set.

$$Xz = X_n \overline{F_1} \overline{F_3} I_x \overline{T_s} + \dots$$

If the Index flip-flop Ix is not set, then zero will be added to the C register and the address will remain the same.

$$sC_0 = \phi_0 \text{ Add } Q_2 \overline{P_0} (\phi_0 \overline{I_a} \overline{O_2} \overline{O_3} O_1) + \dots$$

Note that the addition only takes place from T23 through T10. The last term is to inhibit indexing in this manner during branch instructions 41 and 43. Branch instructions (01, 41, and 43) are indexed by running the adder directly into P1.

$$sP_1 = (\phi_0 \overline{I_a} \overline{O_2} \overline{O_3}) \text{ Add}$$

$$P_g = \textcircled{Kr} Q_2 \overline{T_s} G_o \phi_0 \overline{I_a} \overline{O_2} \overline{O_3}$$

At T9 the address has shifted completely around so that it is in the upper half of the C register and, at this time, it is transferred in parallel to the S register in order to access the operand.

$$S_{xc} = T_9 \phi_0 \overline{P_0} ( \dots + O_3 + O_2 ) + \dots$$

## INDIRECT ADDRESS OPERATION

All instructions begin at  $\emptyset 0$  T24 with the complete instruction in the C register. At the end of pulse time T24 the 6-bit instruction code is transferred to the instruction register.

$$O_{xc} = T24 \emptyset 0 \overline{Ia} \overline{C2}$$

If the instruction contains an indirect address bit in C9 during T24  $\emptyset 0$ , the indirect address flip-flop, Ia, is set.

$$sIa = T24 \overline{Ia} \overline{Go} \emptyset 0 \overline{C2} C9 + \dots$$

C2 is the program operator bit which inhibits indirect addressing.

An indirect address bit programmed with a single-cycle instruction (except BRU and EXU) has no effect, since the Ia flip-flop is set in any event to increment the P register (Program Counter). The indirect addressing in this case is ignored.) For any other instruction the Ia flip-flop inhibits the phase count and allows an additional cycle of phase  $\emptyset 0$ .

Indexing may occur on the first address during phase  $\emptyset 0$  and at T9 the address (of the "indirect instruction") is transferred to the S register for accessing. At pulse time Tp the indirect instruction is transferred from M to the C register.

At T24 of this second cycle of phase  $\emptyset 0$  the transfer of the instruction code to the O register is inhibited by Ia.

$$O_{xc} = \emptyset 0 T24 \overline{Ia} \overline{C2} \overline{Go}$$

Ia is reset at this second T24 unless another indirect address bit is present. In this case it is not reset and another cycle of indirect address takes place.

$$rIa = T24 \emptyset 0 \overline{C9} Ia \overline{Go} + \dots$$

C9 represents the new indirect address bit. When Ia is finally reset at some T24, the real operand (effective address) is obtained from memory and the instruction is executed.

Indexing will take place on any indirect address cycle where an index bit is present.

## PROGRAM OPERATOR

When an instruction is executed that has a "program operator" bit, the computer stores the contents of the P register in memory word zero and transfers control to the address specified by the seven-bit instruction code, including the program operator bit itself. For example, an instruction,

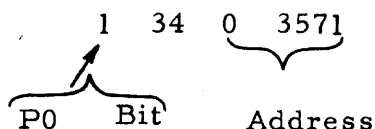

will cause a transfer to word 134 after storing the contents of the P register (location of above instruction) in word zero. The contents of the overflow flip-flop are stored in the sign position of word zero and the overflow flip-flop is reset. An indirect address bit is also stored in word zero. The addressed subroutine can then indirect address word zero, which, in turn, can indirect address the location of the above instruction, which, in turn, will address the operand in 03571.

At time  $\phi_0$  T24 (start of the instruction) the P0 (program operator) flip-flop is set, if C2 in the C register contains a "program operator" bit.

$$sP0 = C2 (\phi_0 \bar{I}a T24 Go) + \dots$$

It is reset at the start of the next cycle.

$$rP0 = T24 P0 + \dots$$

The operation takes two cycle times. The phasing is shown below with one cycle time in each phase.

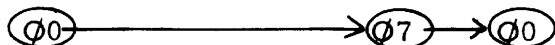

During  $\phi_0$  Q2 the P register is shifted into C for eventual storage in word zero.

$$sC0 = (P0 \phi_0) Q2 P14 + (P0 \phi_0) T9 + (P0 \phi_0) Of T0 + \dots$$

The second term above inserts an indirect address bit in word zero so that the true operand of the original instruction can be easily accessed indirectly. The third term inserts the contents of the Of (overflow) flip-flop in the sign position,

$$rOf = \phi_0 P0 T0 + \dots$$

and the overflow flip-flop is reset.

The O register is not set at  $\phi_0$  T24 as usual, because the transfer is inhibited.

$$Oxc = \phi_0 T24 \bar{I}a \bar{C}2 Go$$

The O register remains reset in the 20 (NOP) configuration. As P is shifting into C, the 7-bit instruction code, which is now the transfer address in C, is shifted into the P register.

$$sP1 = C8 P0 \phi_0 \bar{Q}1 Q2 + \dots$$

This is followed by 7 zeros into the P register.

$$Pg = (\text{Kr}) Q2 \bar{T}s Go P0 \phi_0 + \dots$$

At  $\phi_0$  Tp the memory register is cleared and memory is pulsed for storage,

$$Mc = Tp P0 + \dots$$

and at T24  $\phi_7$  the word constructed in C is transferred to the M register for storage and P0 is reset.

$$Mxc = T24 P0$$

$$rP0 = T24 P0 + \dots$$

The S register is cleared at T10  $\emptyset 0$ , as usual, for receiving the address of the operand,

$$Sc = T10 \overline{T_s} \overline{F1} \overline{F2} + \dots$$

But P0 inhibits the usual C to S transfer.

$$Sxc = T9 \emptyset 0 \overline{P0} (Ia + 03 + 02)$$

Therefore, the address remains zero. At T<sub>p</sub>  $\emptyset 0$  the phase changes to phase  $\emptyset 7$ .

$$sF1 = sF2 = sF3 = T_p \overline{T_s} P0 + \dots$$

During phase  $\emptyset 7$  word zero is stored, P is transferred to S at T9 and the instruction from this new address is accessed.

Note that address positions 100 through 177 must always be reserved for program operator instructions and that these instructions, in turn, must be BRU instructions to transfer to other starting locations outside the reserved field.



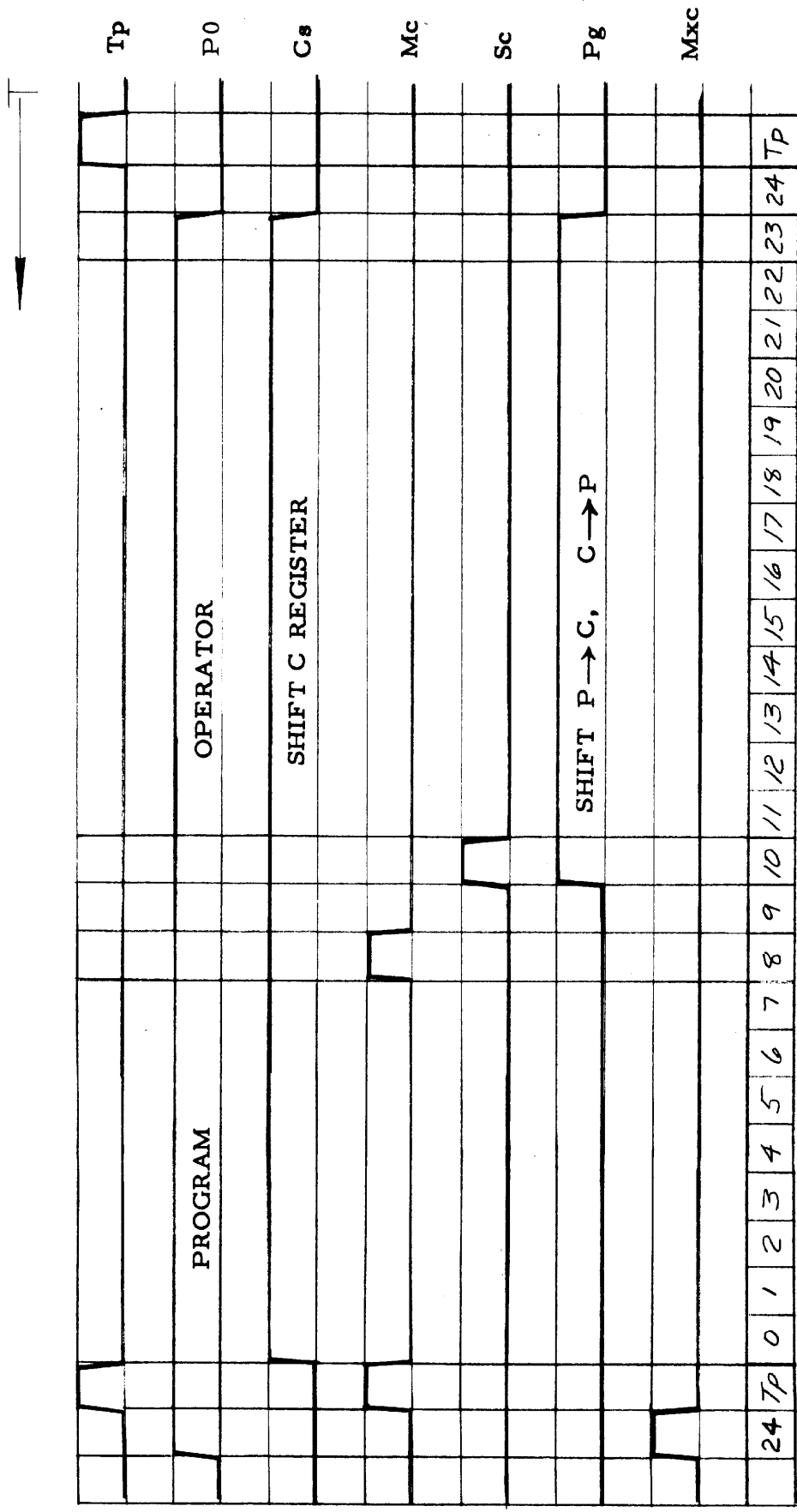

TIME →

FIGURE 8  
PROGRAM OPERATOR

## MANUAL AND TIMING CONTROL

### INTERRUPT

The computer can be interrupted by an external signal through the priority interrupt logic which causes the computer to access an address assigned to the interrupting channel. The location addressed usually contains a 43 (BRM) instruction, which stores the location of the present instruction and branches to the interrupt subroutine.

Interrupt channels 3 and 4 are designated  $I_3$  and  $I_4$ , with  $I_3$  being of higher priority. Interrupt channels can be used in additional groups of 16. When interrupt line  $I_4$  requests an interrupt, a flip-flop designated  $Is_4$  is set to establish the request.

$$sIs_4 = (\underline{T_{22}} - T_{17}) I_4$$

The underlined term is used as a clocking term.

If there are no higher priority requests present, then an "interrupt request" is sent to the computer,

$$Ir = \dots + Is_4 \overline{Is_3} \overline{Ip_4} \overline{Is_1} \overline{Is_2} + \dots$$

Note that a request will not be sent, if  $Is_3$  (a higher priority) is true, or priorities higher than  $Is_3$  are true. The computer will set the interrupt flip-flop ( $Int$ ) at  $T_{10}$  of the first end cycle, if a request is present.

$$sInt = T_{10} \text{ End } Ir$$

The time elapsed between the request signal  $Ir$  and the actual interrupt  $Int$  varies according to the length of time necessary to complete the instruction that the computer is performing when the request is made.

If the computer was halted from a Halt instruction (not a parity error), and the Control switch is in the "Run" position, an interrupt request will allow the computer to run.

$$rHt = K_g Int \overline{C_p} + \dots$$

$Ht$  is a Halt control flip-flop and  $C_p$  is the parity flip-flop.

When the  $Int$  (Interrupt) flip-flop is on, the transfer from P to S which usually takes place is inhibited.

$$S_{xp} = T_9 \text{ End } \overline{Int} + \dots$$

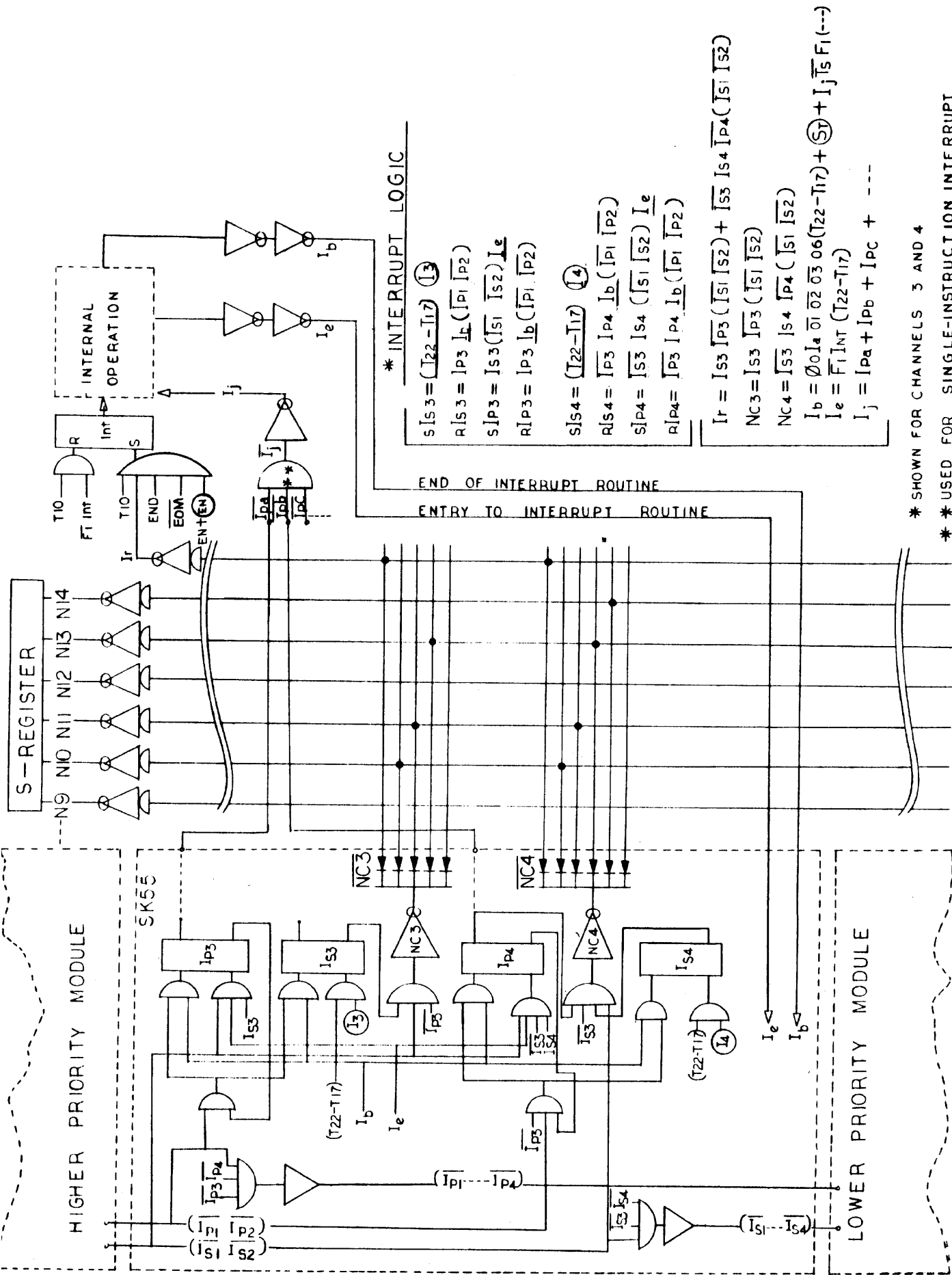

\* SHOWN FOR CHANNELS 3 AND 4  
 \*\* USED FOR SINGLE-INSTRUCTION INTERRUPT (APPLICABLE ON CHANNELS 5 → N ONLY)

PRIORITY INTERRUPT SYSTEM  
 FIGURE 9

Instead, ten address lines labeled N5 through N14, controlled by the priority interrupt system, are transferred to the least significant bits of S to address a pre-assigned subroutine.

$$S_{xn} = T9 \text{ Int } \overline{T_s}$$

$$sS14 = S_{xn} N14 \text{ (S5-S13 are set in a similar way.)}$$

During the first cycle after the last "End" an interrupt "acknowledgment" signal (Int  $\overline{F1}$ ) is sent back to the priority logic and the Int flip-flop is reset.

$$r\text{Int} = T10 (\text{Int } \overline{F1})$$

$\overline{F1}$  signifies that the computer is not in an End cycle. The interrupt acknowledgment signal sets a flip-flop labeled Ip4 (Ip3 for the higher channel) which, in turn, cancels the request and signifies that the computer is now in interrupt subroutine "4".

$$sIp4 = Is4 \overline{Is3} \underline{I_e} \overline{Is1} \overline{Is2}$$

$$I_r = - - - + \overline{Is3} Is4 \overline{Ip4} \overline{Is1} \overline{Is2}$$

If a higher priority interrupt ( $\textcircled{I3}$ ) occurs during the execution of interrupt subroutine "4", it will interrupt accordingly. Or if  $\textcircled{I3}$  requests an Interrupt before interrupt  $\textcircled{I4}$  is acknowledged, then interrupt  $\textcircled{I3}$  will be acknowledged instead and interrupt subroutine "4" will not begin until interrupt subroutine "3" is completed.

$$I_r = Is3 \overline{Ip3} (\overline{Is1} \overline{Is2}) + - - -$$

The end of an interrupt subroutine is signaled by a term labeled Ib, which is enabled by an 01 (BRU) instruction with indirect addressing.

$$I_b = (\textcircled{0} Ia \overline{01} \overline{02} \overline{03} 06) (T22 - T17)$$

This term will reset only the highest priority interrupt channel as the others are either in a request state or were interrupted in the execution of their routine.

$$rIs3 = Ip3 \underline{I_b} \overline{Ip1} \overline{Ip2} + \overline{St} \boxed{dc}$$

$$rIp3 = Ip3 \underline{I_b} \overline{Ip1} \overline{Ip2} + \overline{St} \boxed{dc}$$

$$rIs4 = \overline{Ip3} Ip4 \underline{I_b} \overline{Ip1} \overline{Ip2} + \overline{St} \boxed{dc}$$

$$rIp4 = \overline{Ip3} Ip4 \underline{I_b} \overline{Ip1} \overline{Ip2} + \overline{St} \boxed{dc}$$

If the end cycle that causes Int to be set is terminating a skip instruction and a skip occurs, the phase is changed to phase  $\textcircled{07}$  to increment P before the interrupt instruction is performed. In this case a higher priority interrupt request could occur during phase  $\textcircled{07}$ , but the N lines are transferred again during phase  $\textcircled{07}$  so that the higher priority subroutine would be entered. This is the reason for  $\overline{F1}$ . The computer cannot acknowledge the lower priority program because it will be entering a higher priority program instead. Study the interrupt timing diagrams for these relationships.

If  $T_s$  is set after Int is set and if a higher priority is set during the  $T_s$  time, the 43 instruction from the first interrupt will be executed before the higher priority interrupt begins because the acknowledgment of the interrupt is not qualified by  $\overline{T_s}$ ,

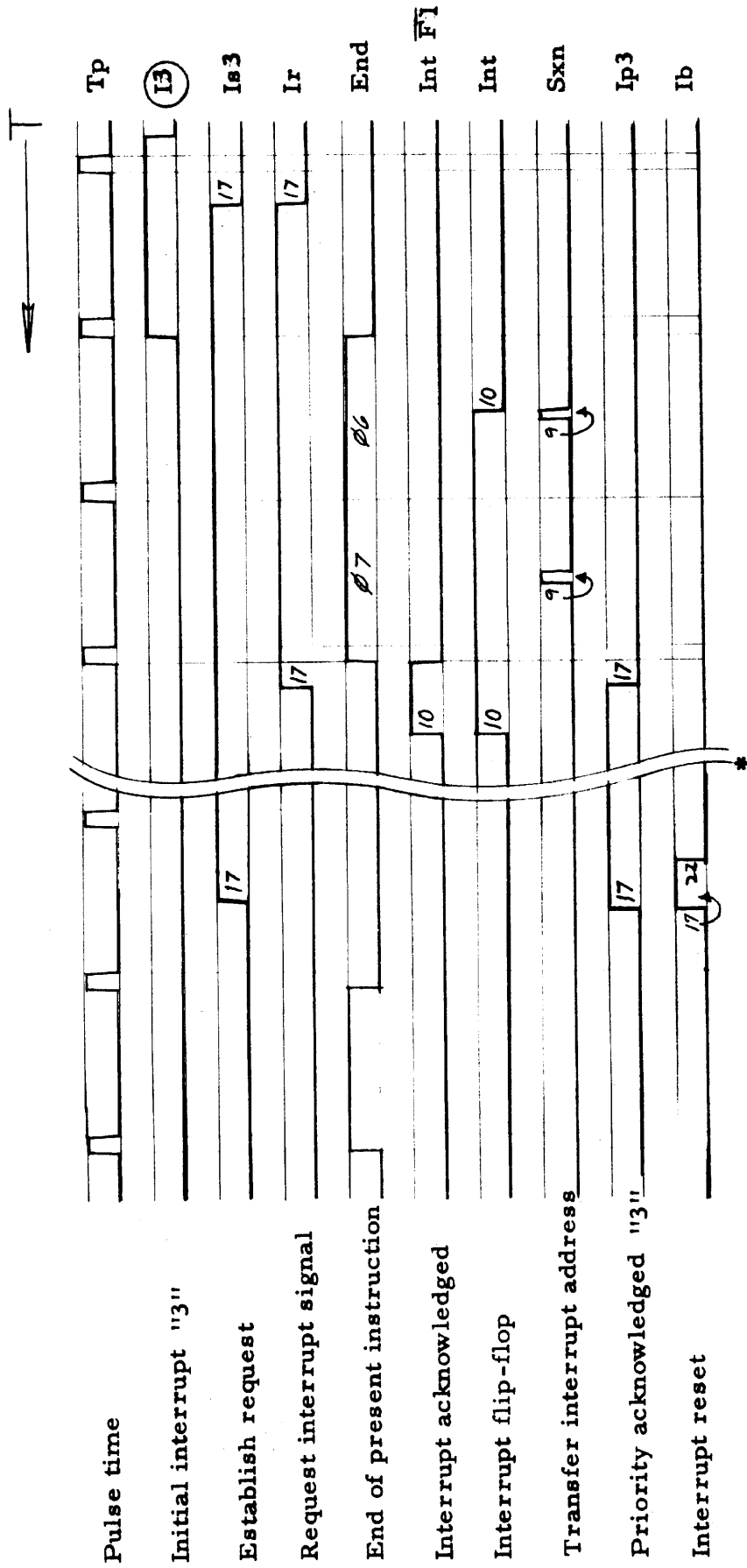

\* Execution of interrupt program

TIME

FIGURE 10  
INTERRUPT TIMING A

Channel 13

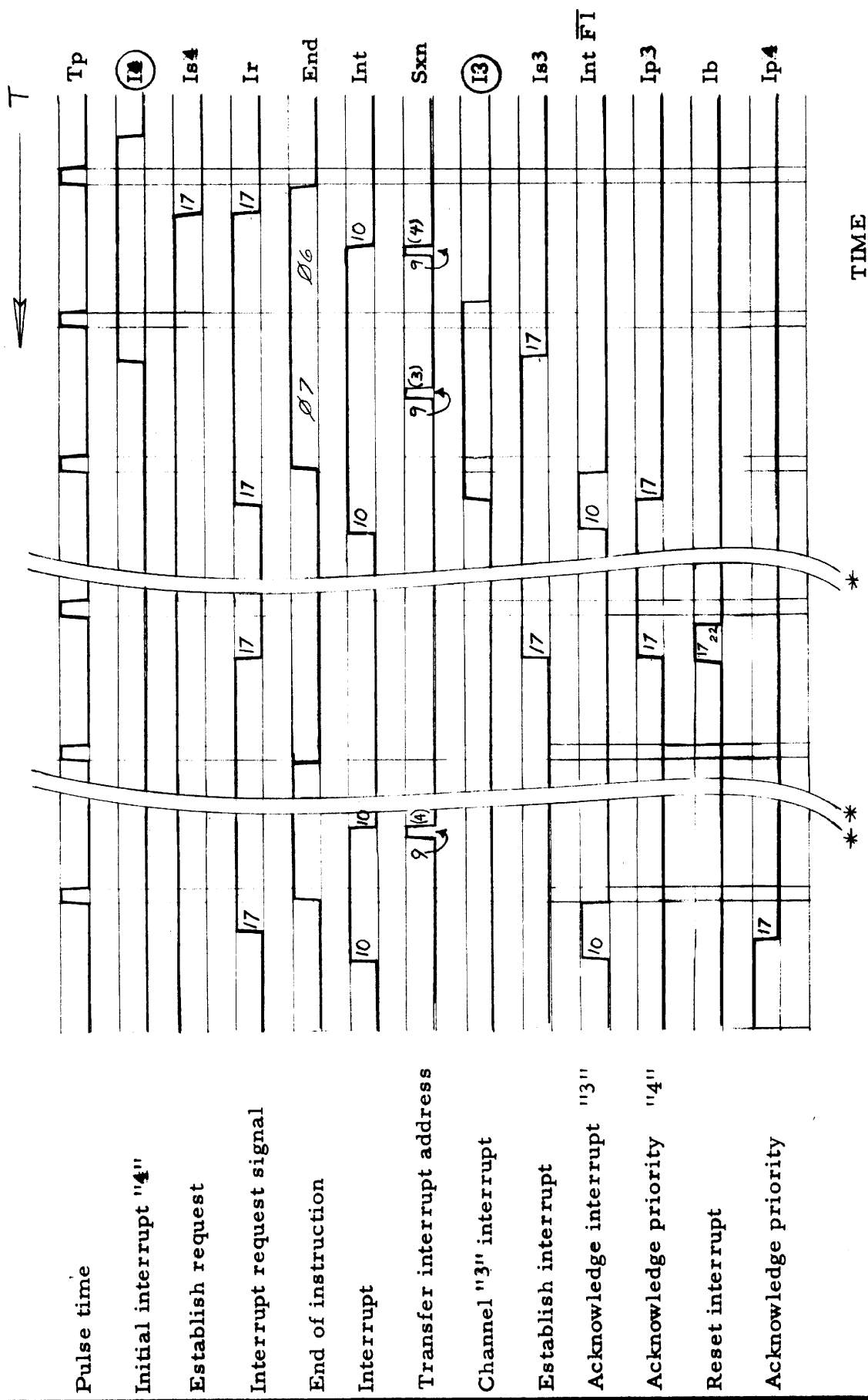

TIME

FIGURE 11

INTERRUPT TIMING B  
 "4" interrupted by "3" before "4" is acknowledged.

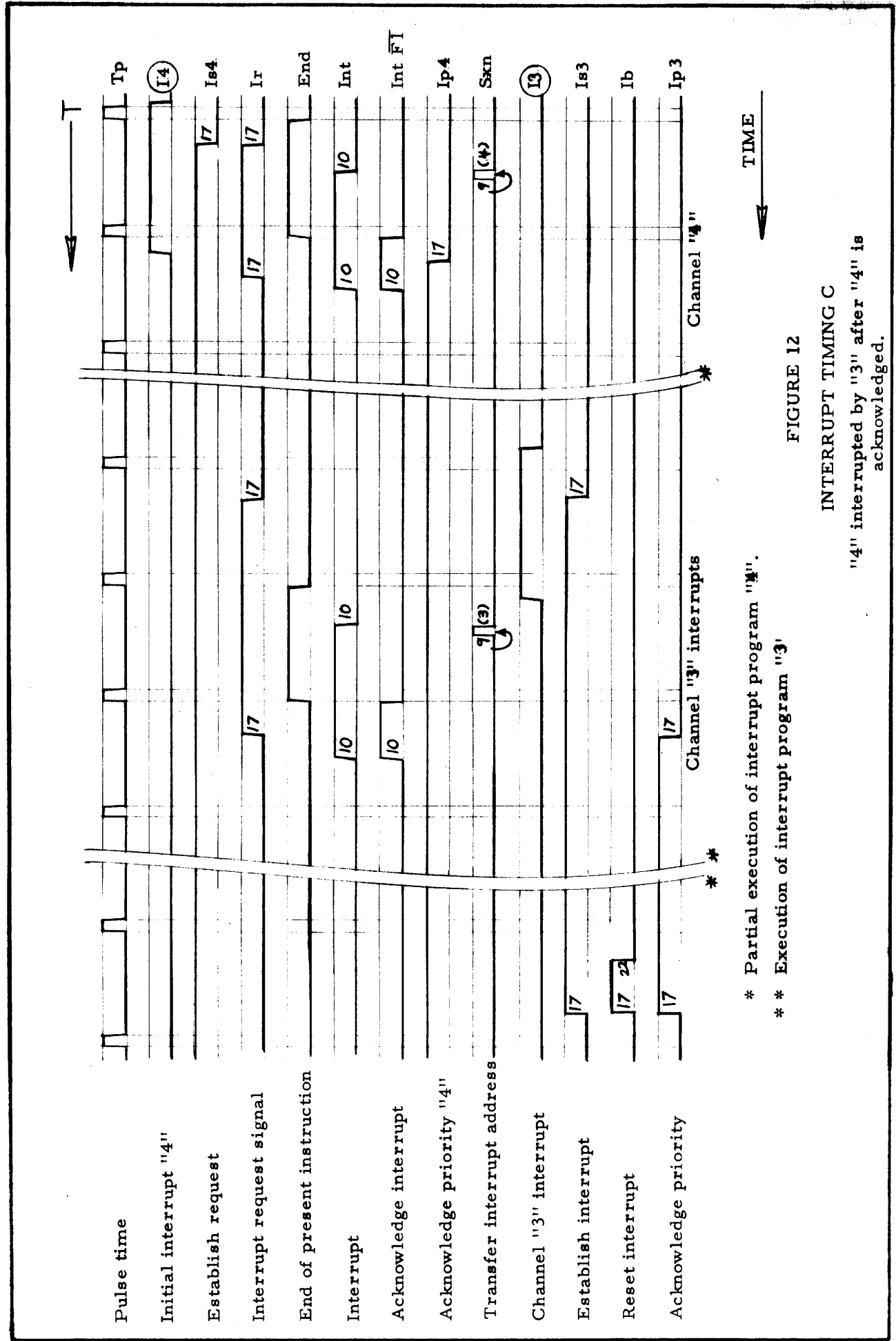

TIME

FIGURE 12  
INTERRUPT TIMING C

"4" interrupted by "3" after "4" is acknowledged.

\* Partial execution of interrupt program "4".  
\*\* Execution of interrupt program "3"

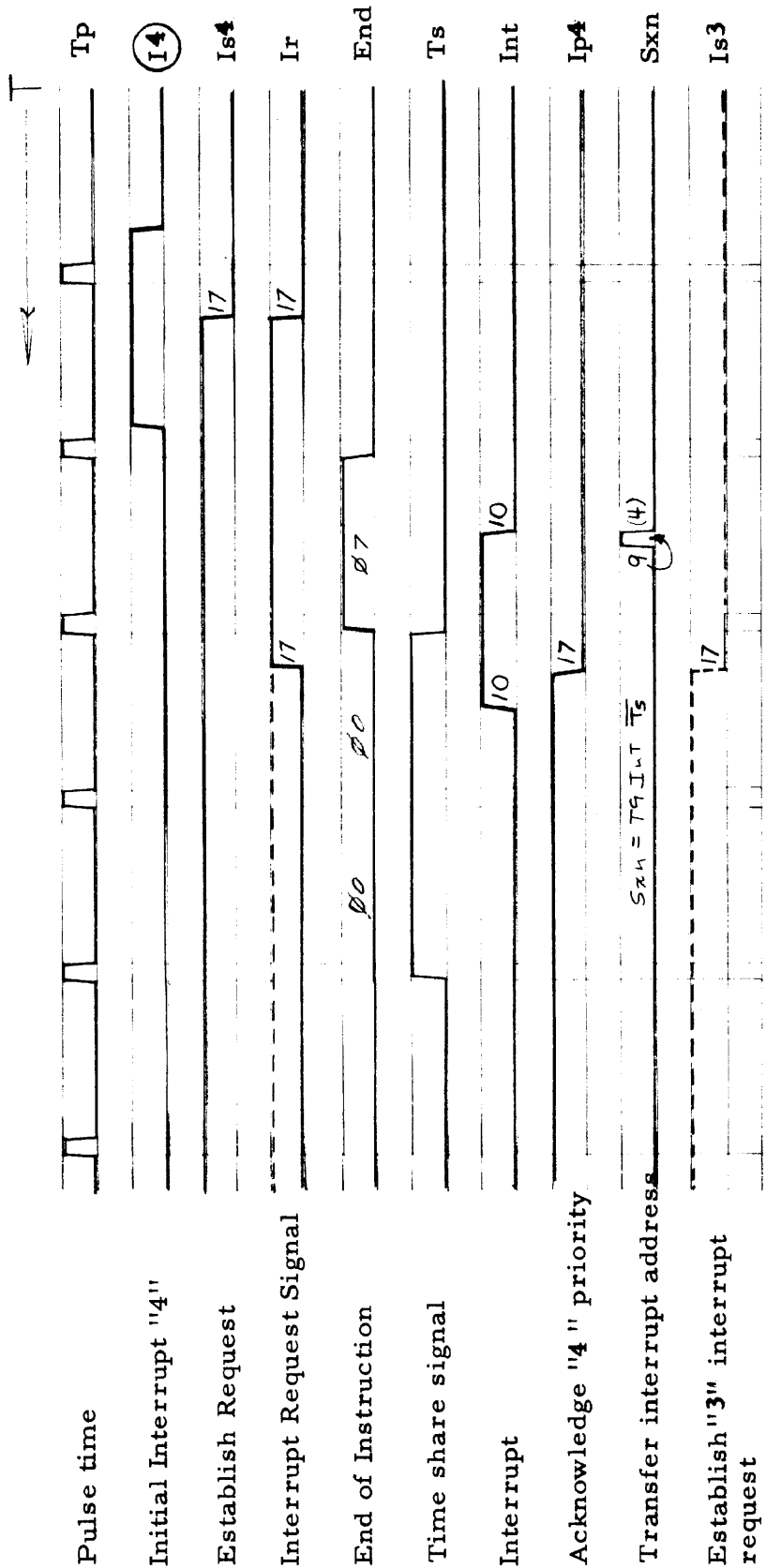

FIGURE 13  
 INTERRUPT TIMING D  
 Channels (14) and (13) in combination with  
 (Ts) Time-Share.



$$I_e = \text{Int } \overline{F1} (T22 - T17)$$

and the higher priority interrupt will require an end cycle to interrupt and the first end cycle will be the end cycle of the 43 instruction in the lower priority program. Refer to the interrupt timing diagram showing  $T_s$ .

When any interrupt subroutine is completed,  $I_b$ , which is caused by an indirect branch, resets the interrupt channel flip-flops, and the P register is then set to the value it had when the interrupt occurred. If an intervening priority channel is waiting, it will not be recognized until the end cycle of the indirect transfer instruction, by which time P has the proper contents to be stored by the intervening priority channel. Any of the external interrupt channels can be modified for execution of a single instruction (the P count is maintained). This is accomplished by generating an external term  $I_j$ , which represents any external signal designated as a single-instruction interrupt,

$$I_j = I_{pa} + I_{pb} + I_{pc} + \dots$$

where a, b, c, represent the numbers of the desired single-instruction, interrupt channels.

$I_j$  is used to block the incrementing of the P register by disabling the setting of  $I_a$  during phases  $\phi_4$  or  $\phi_6$ .

$$sI_a = T24 F1 \overline{F3} \overline{I_j} + \dots$$

$I_j$  is also used to immediately reset the interrupt system.

$$I_b = I_j \overline{T_s} F1 (T22 - T17) + \dots$$

$I_j$  is implemented as follows:

$$\overline{I_j} = \overline{I_{pa}} \overline{I_{pb}} \overline{I_{pc}} \dots$$

$$I_j = \overline{\overline{I_j}}$$

### TIME-SHARE (MEMORY INTERLACE)

With the optional W or Y Buffer time-share interlace equipment the memory can be automatically shared between the W and/or Y Buffer and the computer. Whenever the buffer has received a full word from a peripheral unit, it can momentarily stop the computer and insert the word into the memory without disrupting the program, and without any program control. Similarly, if either W or Y is being used for output, two memory cycles are taken from the computer to reload the buffer whenever the buffer is empty.

The W or Y buffer logic issues a  $T_{sw}$  or a  $T_{sy}$  (time-share request), respectively, to request use of the memory. At the next  $T_p$  time the  $T_s$  (time-share) flip-flop is set and the computer idles regardless of what it was doing.

$$T_{sw} = \overline{Wf} W0 \overline{Wh} (I_w)$$

$$T_{sy} = \overline{Yf} Y0 \overline{Yh} (I_y)$$

$$sT_s = (T_{sw} + (T_{sy})) T_p$$

Almost all control gates in the computer are disabled when Ts is set. The computer idles wherever it is for the two cycle times that Ts is on, and it resumes operation from that state when Ts is reset. A, B and X registers (dynamic) must recirculate.

Tsw, if true, does not go false until Ts Tp; therefore, Ts is always on for two cycles.

$$rTs = \overline{Tsw} \overline{Tsy} Tp \overline{Tsm} \quad (\overline{Kf})$$

Wp is set if the W Buffer is to use the memory; it is reset if the Y Buffer is to use the memory.

$$sWp = (\overline{Go} + Tsw) \overline{Tsy} \overline{Tsm} Tp$$

$$rWp = (Go \overline{Tsw} + \textcircled{Tsy}) \overline{Tsm} Tp + \dots$$

If both Tsw and Tsy are true at Tp, then Wp will be reset at Tp and the Y Buffer will get the first two Ts cycles. In this case Ts stays set for four cycles, two cycles for each of the two buffers. Wp will be complemented at the end of the second cycle. When Ts is set, almost all terms in the computer are disabled. Most of them are disabled since  $\overline{T_s}$  is ANDed into the expressions for the phases. For example, phase  $\phi_3 = \overline{F1} F2 F3 \overline{T_s}$ . There are exceptions. If P0 is on at Tp when Ts is being set, it causes the Mxc to write in memory at the next T24 regardless of Ts. But except for recirculating the shift registers, A, B and X, the computer basically does not change state while Ts is set. The phase counter is set in the phase that will be executed when Ts is reset. During Ts, the C register and the W register exchange serially (if  $\overline{Wp}$ , C and Y exchange).

$$Cs = Ts (\overline{T24} \overline{Tp})$$

$$sC0 = Ts Wn Wp \overline{Tp}$$

$$+ Ts \textcircled{Yn} \overline{Wp} \overline{Tp} + \dots$$

At Ts T10 the Tsm flip-flop is set for one cycle only.

$$sTsm = Ts T10 \overline{Tsm}$$

$$rTsm = T10 Tsm + \overline{T_s}$$

Tsm is used to modify the memory control. The memory is pulsed at the first Ts T8, but not at the second Ts T8. Tsm controls this,

$$Mc = Q1 \overline{Q2} Q3 \overline{Q4} Q5 (F1 + \overline{F3} + Ts) (Tsm + \overline{T_s}) + \dots$$

and the lines which control the addressing of the memory are not gated from the S register but instead are gated from address lines Iw10 through Iw23 (or Iy10 through Iy23), which are generated in the interlace units,

$$\overline{L1} = S1 \overline{Tsm} + \textcircled{Iw10} (Tsm Wp) + \textcircled{Iy10} (Tsm \overline{Wp})$$

etc. This ensures that the previous word being regenerated during the first part

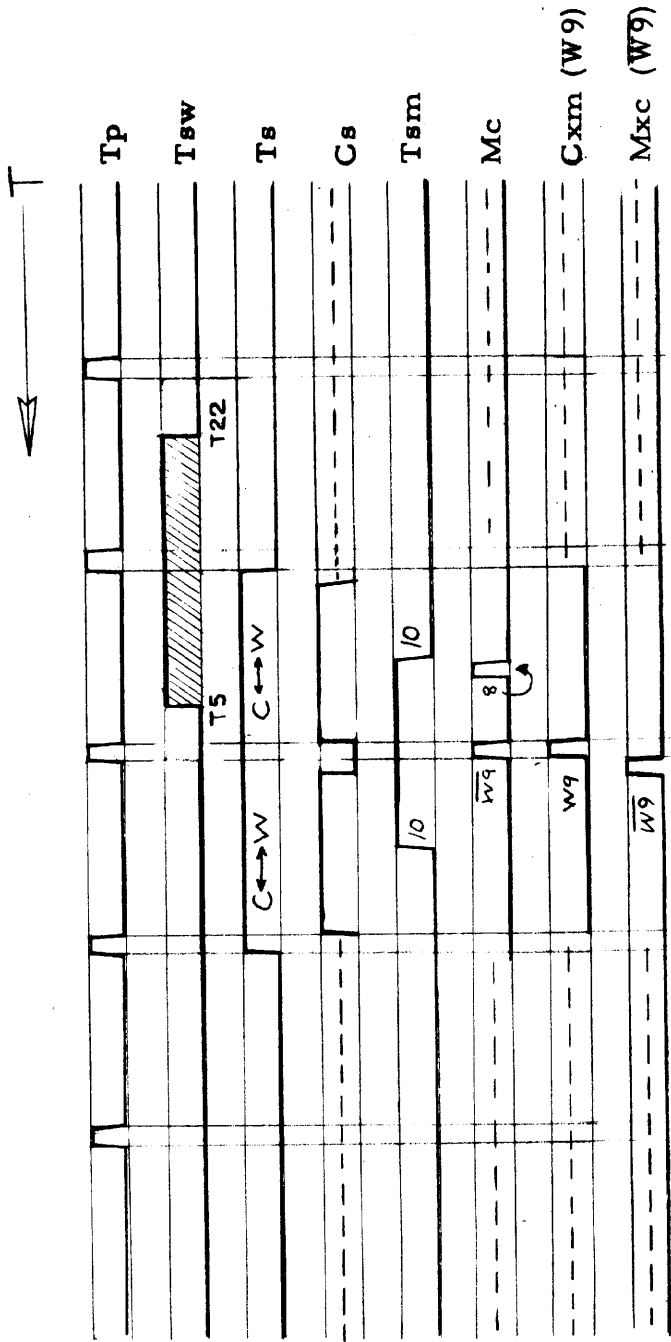

Pulse time

Time-share request

Time-share flip-flop

Shift C register

Ts memory control

Clear M & pulse memory

Transfer M to C

Transfer C to M

TIME

W9 = Output, W9 = Input

FIGURE 14  
INTERLACE TIMING  
(TIME-SHARE)

of  $T_s$  is controlled by the S register. At the first  $T_p T_s$  the word addressed by the buffer has been read from memory. If the buffer is being used for output,  $W_9$ , then M is transferred to C.

$$C_{xm} = T_p T_{sm} \overline{W_p} W_9 T_s \\ + T_p T_{sm} \overline{W_p} \textcircled{Y_9} T_s$$

Here  $T_{sm}$  is used to specify the first  $T_p T_s$  and not the second. If the buffer using the interlace is being used for input,  $\overline{W_9}$ , the memory register is cleared at this  $T_p$  and  $P_0$  is set to remember to load M from C at  $T_{24}$ .

$$M_c = T_p T_s \overline{W_9} (T_{sm} \overline{W_p}) \\ + T_p T_s \textcircled{\overline{Y_9}} (T_{sm} \overline{W_p}) \\ sP_0 = M_c T_p \\ rP_0 = (P_0 T_{24}) \\ M_{xc} = (P_0 T_{24})$$

During the second cycle of  $T_s$  the buffer register and the C register again exchange serially. At the second  $T_p T_s$  the C register again contains the number it originally contained when  $T_s$  was just set and the buffer register, if used for output, contains the requested word from memory.

$T_s$  is reset at this second  $T_s T_p$  and the computer continues. Refer to the "Time-Share" timing diagram.

The buffer waits two cycle times after the  $T_{sw}$  signal is given before it precesses the next character in or out, unless both buffers are interlacing. In this case, the waiting time is four cycles.

Interlacing can take place regardless of the state of the Go and Ht (control) flip-flops, regardless of the position of the Control switch, and regardless of the position of the Register Display switch.

## CONTROL SWITCH

The Control switch is a three-position switch on the control panel of the computer labeled "Run-Idle-Step."

In the "Idle" position, the computer idles by inhibiting the advance of the P register, and by repetitively executing a "NOP" instruction.

In the "Run" position, the computer executes instructions as required until: a Halt instruction is executed, the switch is placed in the Idle position, or a parity error occurs with the Parity Override switch in the Halt position.

In the "Step" position, the computer executes the instruction in the C register, reads the next instruction and halts. The switch locks in the Run or Idle positions, but must be held in the Step position.

The Control switch controls two flip-flops designated Go and Ht, which, in turn, control the state of the computer.

$\overline{\text{Go}} \overline{\text{Ht}} = \text{Halt, Ready to run}$

$\text{Go} \overline{\text{Ht}} = \text{Run}$

$\text{Go} \text{Ht} = \text{Run, but the computer will halt at completion of the Instruction}$

$\overline{\text{Go}} \text{Ht} = \text{Halt, the computer will not run until the switch is returned to Idle and back to Step or Run}$

Refer to the control switch diagram for the following discussion.

The two signals supplied by the Control switch are  $\text{Ks}$ , which is true when the switch is in the Step position, and  $\text{Kg}$ , which is true when the switch is in the Run position. Both of these signals are false when the switch is in the Idle position.

If the switch is put in Run, the Go flip-flop is set at the next  $\text{Tp}$ .

$$s\text{Go} = \text{Tp} \text{Kg} \overline{\text{Ht}} - - - + - - -$$

The Ht flip-flop is not set to stop the computer unless: a Halt instruction is executed, the switch is placed in Idle, or a parity error occurs with the Parity Override switch in the Halt position or while the Control switch is in the Step position.

$$s\text{Ht} = \overline{\text{Kg}} \text{Go} \text{T0 End} + \text{T0 } \text{O5 } \overline{\text{O1}} \overline{\text{O2}} \overline{\text{O5}} \overline{\text{Int}} \\ + \text{Cp Tp} \text{Kp} \overline{\text{Ts}} - - - -$$

During a Halt instruction Ht is set at T0 and Go is then reset at  $\text{Tp}$ .

$$r\text{Go} = \text{Tp End} \overline{\text{Sk}} \text{Ht} + - - -$$

The Ht flip-flop remains set until the switch is returned to Idle.

If the switch is set to Idle when the computer is running, Ht is set at T0 just before the end of the instruction is being performed,

$$s\text{Ht} = \overline{\text{Kg}} \text{Go} \text{T0 End} + - - -$$

and Go is reset at the next clock time,  $\text{Tp}$ , stopping the computer.

$$r\text{Go} = \text{Tp End Ht} \overline{\text{Sk}} + - - -$$

Then Ht is reset, since Go is in the reset state.

$$r\text{Ht} = \overline{\text{Ks}} \overline{\text{Kg}} \overline{\text{Go}} \overline{\text{Cp}} \text{T24} + - - -$$

If the switch is depressed to the Step position, Go is set at the next  $\text{Tp}$  time and the instruction set up in the C register is performed.

$$s\text{Go} = \text{Tp} \text{Ks} \overline{\text{Ht}} - - - + - - -$$

At T0 of the last cycle of the instruction, Ht is set and at  $\text{Tp}$ , Go is reset, and the computer idles. As long as the switch is held in the Step position, Ht stays set preventing Go from being set again. When the switch is released, Ht is reset;

GH Counter	RUN	IDLE	STEP	Position of control switch
	$\text{Kg}$ $\text{Ks}$	$\text{Kg}$ $\text{Ks}$	$\text{Kg}$ $\text{Ks}$	Outputs from control switch
$\overline{\text{Go}}$ $\overline{\text{Ht}}$	$\overline{\text{Go}}$ $\overline{\text{Ht}}$			Halt, ready to go
Advance	$\text{Tp}$ $\text{Kg}$ $\overline{\text{Ht}}$		$\text{Tp}$ $\text{Ks}$ $\overline{\text{Ht}}$	Set $\text{Co}$
$\text{Go}$ $\overline{\text{Ht}}$	$\text{Go}$ $\overline{\text{Ht}}$			Go, computer will run until a halt occurs or the switch is placed in idle, or the computer will perform one instruction if the switch is in the step position.
Advance	$\text{T0} \overline{\text{Cp}} \overline{\text{Kp}} \overline{\text{Ts}} \overline{\text{Int}}$ $+ \text{Cp} \text{Tp} \text{Kg} \text{Ts}$	$\text{T0} \text{End} \text{Kg} \text{Go}$		Set $\text{Ht}$
$\text{Go}$ $\text{Ht}$	$\text{Go}$ $\text{Ht}$			Go but the computer will halt upon completion of the instruction.
Advance	$\text{Tp} \text{End} \text{Ht} \overline{\text{Sk}}$			Reset $\text{Go}$
$\overline{\text{Go}}$ $\text{Ht}$	$\overline{\text{Go}}$ $\text{Ht}$			Halt, the computer will not go until the switch is placed in idle.
Advance	$\overline{\text{Go}}$ $\text{Ks}$ $\text{Kg}$ $\overline{\text{Cp}}$ $\text{T24}$			Reset $\text{Ht}$ (idle position)
$\overline{\text{Go}}$ $\overline{\text{Ht}}$	$\overline{\text{Go}}$ $\overline{\text{Ht}}$	$\text{Halt}$		

FIGURE 15  
CONTROL SWITCH

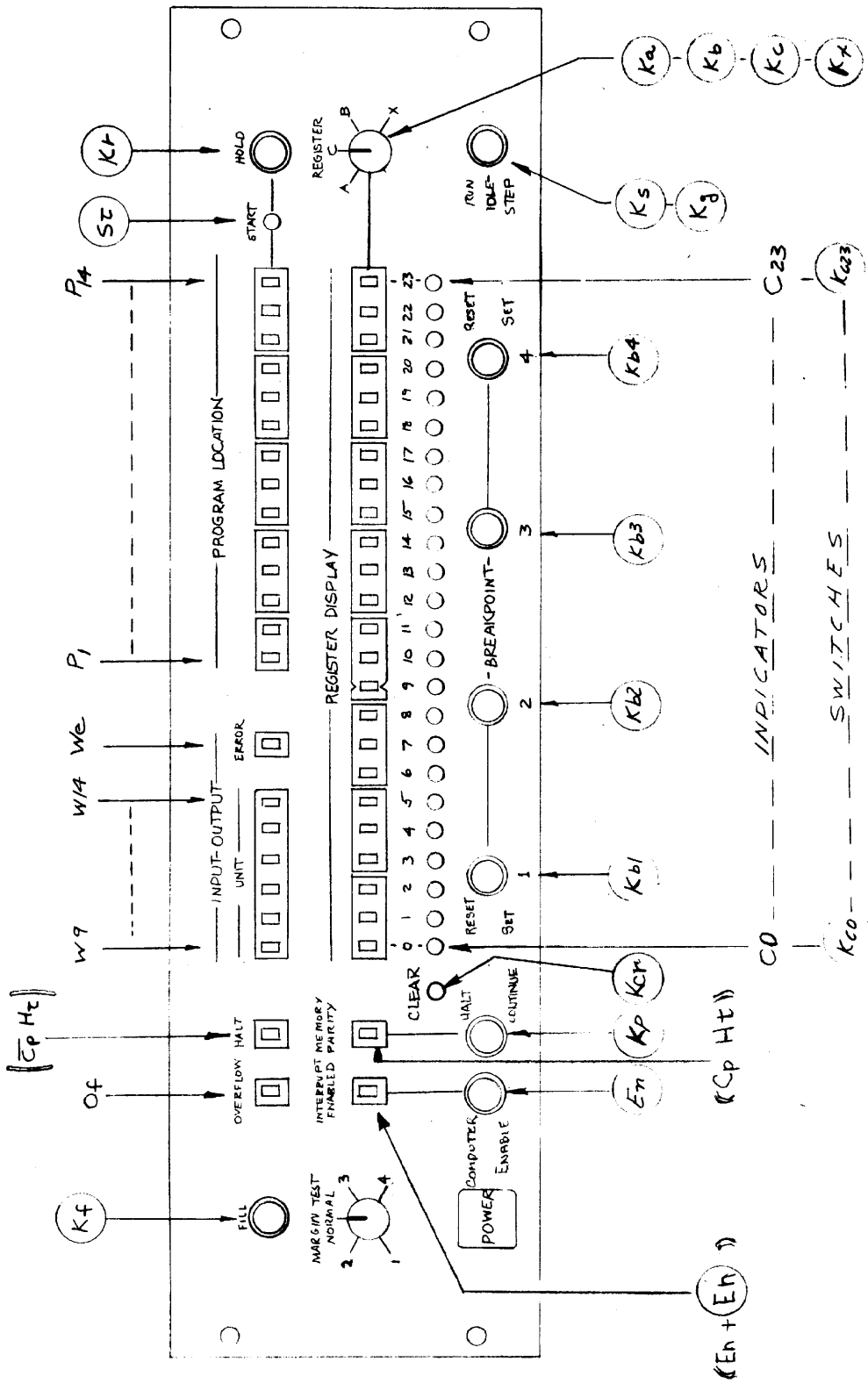

FIGURE 16  
CONTROL PANEL

but now Go has lost its  $\textcircled{Ks}$  input requirement.

The Go flip-flop controls whether the computer executes instructions or not. It does so by inhibiting Oxc, which sets up the new operation code. Therefore, a NOP (20) instruction is set up in the O register and is performed repetitively.

$$Oxc = \emptyset 0 \text{ Go } T24 \bar{Ia} \bar{C2} + - - -$$

$$Oc = Tp \text{ End } \bar{Sk} + - - -$$

The P register does not shift while Go is reset so that it cannot be incremented and can be displayed on the control panel.

$$Pg = - - - Q2 \bar{Ts} \text{ Go } + - - -$$

The transfer from the M register to the C register is inhibited so that the word set up in C is not destroyed.

$$Cxm = Tp \text{ End } \text{Go} + - - -$$

C does not shift in the execution of a NOP instruction regardless of Go because repetitive NOP executions hold the phase counter in phase  $\emptyset 5$  where C does not shift.

### REGISTER SWITCH

When Go and Ht are both reset, it is possible to display the A, B or X registers in place of the C register. This is accomplished by interchanging the contents of the register to be displayed and the C register. The contents must, of course, be switched back before computation is resumed.

Two flip-flops, D1 and D2, in the computer, "remember" which of these registers is being displayed in the C register.

$$\bar{D1} \bar{D2} = \text{C Register}$$

$$\bar{D1} D2 = \text{B Register}$$

$$D1 \bar{D2} = \text{A Register}$$

$$D1 D2 = \text{X Register}$$

When the computer first reaches the  $\bar{Go} \bar{Ht}$  configuration, D1 and D2 are both reset indicating that all registers are "home" (the contents are in their original registers).

$$rD1 = \emptyset 0 \text{ Go } + - - -$$

$$rD2 = \emptyset 0 \text{ Go } + - - -$$

If the switch is turned to the "A" position, then at the next T24 time a flip-flop designated Ex (Exchange) is set.

$$sEx = - - - \bar{Ts} T24 \bar{Go} \bar{Ht} \bar{D1} \textcircled{Ka'} + - - -$$



Ex controls the timing of the actual interchange and is set for one cycle time.

$$rEx = T0 F1$$

While Ex is set and the switch is in the "A" position, the C and A registers exchange contents.

$$sAw = Anr Ex C23 + - - -$$

$$Anr = Ex \textcircled{Ka} + - - -$$

The C register is enabled by Ex.

$$Cs = Ex + - - -$$

$$sC0 = Ex \textcircled{Ka} An + - - -$$

At pulse time T0 the flip-flops are set to  $D1 \overline{D2}$  indicating that the contents of the A register are in the C register.

$$sD1 = Ex T0 \overline{D1} \textcircled{Ka} + - - -$$

Now if the switch is rotated, it must first pass through the  $\textcircled{Kc}$  position. Ex is set the next T24 time after the switch reaches the C position,

$$sEx = T24 \overline{Ts} \overline{Go} \overline{Ht} D1 \textcircled{Kc'} \textcircled{Kf} + - - -$$

$$rEx = T0 F1$$

and again A and C exchange.

$$sAw = Anr Ex C23 + - - -$$

$$Anr = Ex D1 \overline{D2} + - - -$$

$$sC0 = Ex D1 \overline{D2} An$$

At Ex T0 the flip-flops change back to the  $\overline{D1} \overline{D2}$  configuration.

$$rD1 = Ex T0 D1 + - - -$$

There are two sets of contacts on the Register switch. One set is "break before make" and the other set is "make before break." The "break before make" contacts are indicated by the ' (prime) and are used to set Ex. The "make before break" contacts are used to control the exchanges. This ensures that the exchanges will not be interrupted by bouncing contacts, since the "exchange" contacts are well made before Ex is set. If the Register switch is turned to the  $\textcircled{Kb}$  position, Ex is set at T24,

$$sEx = T24 \overline{Ts} \overline{Go} \overline{Ht} \overline{D2} \textcircled{Kb'} \textcircled{Kf} + - - -$$

$$rEx = T0 F1$$

the B and C registers interchange,

$$sBw = Bnr Ex C23 + - - -$$

$$Bnr = Ex \textcircled{Kb}$$

$$sC0 = Ex \textcircled{Kb} Bn + - - -$$

and at T0 the flip-flops are set in the  $\overline{D1} D2$  configuration:

$$sD2 = Ex T0 \overline{D2} (Kb) + \dots$$

If the switch is advanced further to the  $(Kx)$  position, it first advances through another  $(Kc')$  position, which causes the registers to first return home and the D1 and D2 flip-flops to be reset to the  $\overline{D1} \overline{D2}$  configuration. If the Register switch is not at the C position when the Control switch is placed into Step or Run, Ex comes on to send the registers home.

$$sEx = T24 \overline{T_s} \overline{Go} \overline{Ht} (D1 + D2) (Kf) (Ks + Kg) + \dots$$

$$rEx = T0 F1$$

For example, if in the  $(Kx)$  position, the C and X registers interchange,

$$sXw = Xnr Ex C23 + \dots$$

$$Xnr = Ex D1 D2 + \dots$$

$$sC0 = Ex D1 D2 Xn + \dots$$

and at T0 the flip-flops will be set in the  $\overline{D1} \overline{D2}$  configuration,

$$rD1 = Ex T0 D1 + \dots$$

$$rD2 = Ex T0 D2 + \dots$$

and the Go flip-flop is not set to start computation until the registers are home.

$$sGo = \overline{D1} \overline{D2} Tp ((Kg) \overline{Ht} + (Ks) \overline{Ht})$$

The Register switch can, of course, be turned safely while the computer is running, since D1 and D2 are not concerned with the register position at this time and Ex will remain reset.

During the Step operation the C register is displayed when the Control switch is held down because Ht remains set. When the control switch is released, Ht is reset and the Register switch may cause an exchange. If the computer halts due to a Halt instruction or a parity error, an exchange cannot occur until the Control switch is returned to Idle, or in the case of a parity error, until the Parity Override switch is put in the Continue position.

## MANUAL CONTROL SWITCHES

There are several manual switches on the front panel for controlling the computer. The Control and Register switches have been discussed in the preceding pages, and the Fill and Start switches are discussed on the following pages. The others are described below.

### Hold:

The Hold switch,  $(Kr)$ , inhibits the incrementing of the P register. It does so by disabling Pg which enables the P register.

$$Pg = (Kr) Q2 \overline{T_s} Go \dots$$

### Parity Override:

The Parity Override switch,  $(Kp)$ , when it is in the "Continue" position, disables the gate which causes the computer to halt if there is a memory parity error.

$$sHt = C_p T_p Go (Kp) \overline{T_s} + - - -$$

If the switch is in the Halt position, it does not allow  $C_p$  to be reset after a parity error.

$$rC_p = (\overline{Kp}) Ht + - - -$$

### Clear:

The Clear switch,  $(Kcr)$ , clears the C register by causing it to shift to the right; zeros are shifted in at the left.

$$C_s = (Kcr) + - - -$$

### C Load Switches:

The C register Load switches ( $(Kc0) \longrightarrow (Kc23)$ ) set the individual C register flip-flops.

$$sC_0 = (Kc_0) + - - - -$$

$$sC_{23} = (Kc_{23}) + - - - -$$

Due to the auxiliary DC inputs on the repeater flip-flops, the C register need not be enabled for this load operation.

### Breakpoint Switches:

The Breakpoint switches are four program switches on the control panel, whose state can be tested for by the computer with the SKS instruction.

$$\begin{aligned} Sks &= C_{10} \overline{C_{11}} C_{15} (Kb_1) \\ &+ C_{10} \overline{C_{11}} C_{16} (Kb_2) \\ &+ C_{10} \overline{C_{11}} C_{17} (Kb_3) \\ &+ C_{10} \overline{C_{11}} C_{18} (Kb_4) \end{aligned}$$

### Enable Switch:

The Enable switch,  $(En)$ , forces the enabling of the interrupt system, regardless of the state of the Enable flip-flop,  $En$ .

$$sInt = T_{10} I_r End (En + (En)) + - - -$$

## START AND FILL SWITCHES

When the computer is first turned on, certain flip-flops must be cleared or set in specified configurations to enable the start of operation.

The Start switch, (St), on the front panel performs this function.

This switch clears the Overflow, the Memory Parity, Skip and the Enable flip-flops.

$$rOf = (\text{St}) + - - -$$

$$rCp = (\text{St}) + - - -$$

$$rSk = (\text{St}) + - - -$$

$$rEn = (\text{St}) + - - -$$

The C register is cleared making ready for a Halt instruction (00).

$$Cs = (\text{St}) (\overline{Tp} \overline{T24}) + - - -$$

The Start switch also clears the W Buffer and the P register, and Go is reset and Ht is set.

$$Wc = (\text{St}) (T5-T0) + - - -$$

$$Pg = (\text{St}) + - - -$$

$$rGo = (\text{St}) + - - -$$

$$sHt = (\text{St}) + - - -$$

If there is a program still in the computer, then a BRU to the start of the program should be set up manually in the C register, and the Control switch placed in the Run position. Then the BRU in the C register is executed and the computer is in operation.

If there is no program in memory, then the Control switch should be placed in the Run position and the Halt instruction in the C register will be executed. The computer halts in the  $\overline{Go}$  Ht configuration. The Ex flip-flop does not cause the exchange of any registers regardless of the Register switch because Ht is on. Then the Fill switch, (Kf), is operated to force the reading of a bootstrap program. The Fill switch, (Kf), sets up the W Buffer to read at four characters per word from photo-reader No. 1. It also forces a WIM 00002 instruction into the C register, and it turns off the Ht flip-flop.

$$sC4 = (\text{Kf}) + - - -$$

$$sC5 = (\text{Kf}) + - - -$$

$$sC7 = (\text{Kf}) + - - -$$

$$sC22 = (\text{Kf}) + - - -$$

$$rHt = (\text{Kf}) + - - -$$

The Fill switch also forces a (-7) into the X register.

$$sXw = \textcircled{Kf} \overline{T21} \overline{T22} + \dots$$

$$Xnr = \textcircled{Kf} (T21 + T22) + \dots$$

This places zeros in positions T21 and T22 and ones in all other positions.

When the Fill switch is released, the Go flip-flop usually turns on at the next Tp time. The computer executes the WIM instruction (input from the W Buffer) when the first word from the tape is ready in the buffer. This word is inserted in memory location 0002. The program counter was cleared with the Start button, it counted once in executing the Halt instruction, and the next instruction is picked up from address 0002. This word is the one just read in from the tape.

The first eight words on the tape should be the following:

<u>Location in Memory</u>	<u>Instruction</u>
0002	2 WIM 00012
0003	BRX 00002
0004	LDX 00011
0005	2 WIM 00000
0006	SKS 21000 (Buffer Ready?)
0007	BRX 00005
0010	(First Instruction)
0011	(Starting Address with Ia Tag)

A flow chart of the program is:

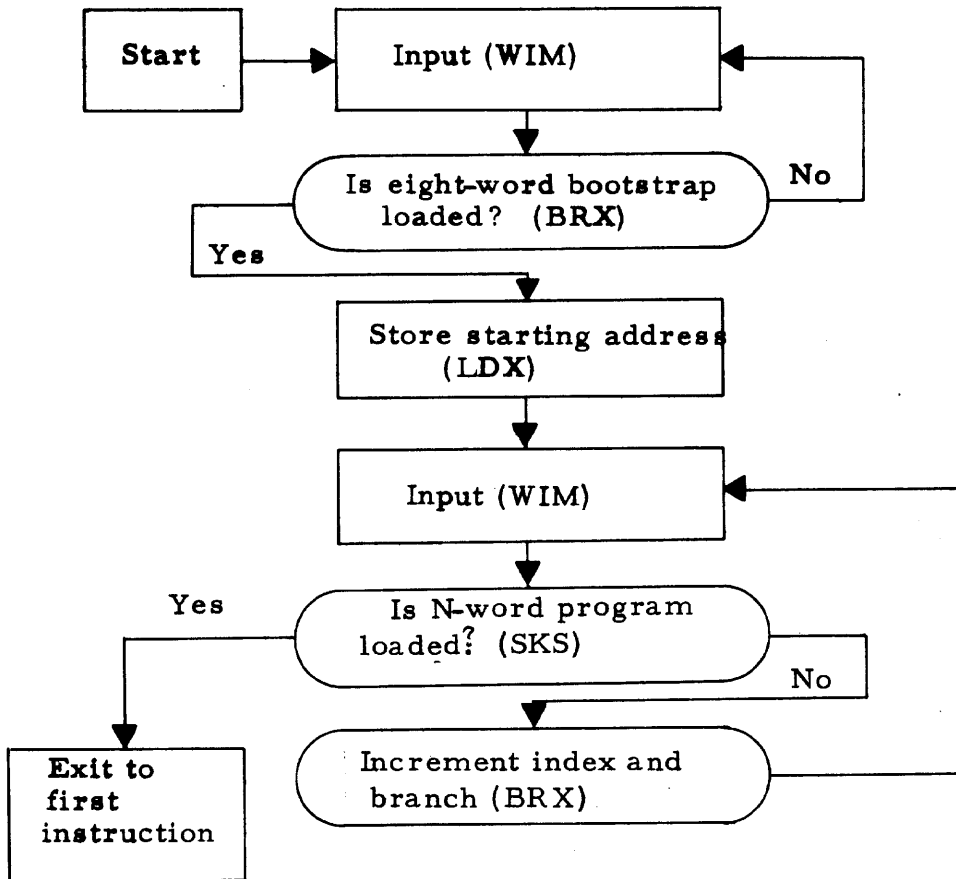

While the Fill switch is held down, Ht is turned off, but neither Go nor Ex will go until the Fill switch is released.

$$sGo = \overline{D1} \overline{D2} \overline{Ts} Tp \overline{Ht} (Ks) + (Kg) Mg (Kf)$$

$$sEx = \overline{Ts} (Kf) T24 \overline{Go} \overline{Ht} ( - - -$$

If, when the switch is released, Go comes on at Tp time, then Ex will be inhibited by Go. If Ex is set first (at T24), then an exchange will occur if the Register switch is not at C. However, Go will not be set until a second exchange returns the register contents home, since the setting of Go requires  $(\overline{D1} \overline{D2})$ , and Ex will be set the second time because the Control switch is in the Run position  $(Kg)$ .

## INSTRUCTIONS

A detailed description of each instruction is included in this material. An intimate knowledge of all preceding descriptions and the Reference Manual is assumed. For additional information on phase changes refer to the phase counter.

### SKIP AND BRANCH INSTRUCTIONS

#### Instruction 01 (BRU)

Phasing:  $\textcircled{\emptyset 0} \longrightarrow \textcircled{\emptyset 0}$

During phase  $\emptyset 0$  the address field in the C register is shifted through the adder for possible indexing and into the P register, and the next instruction is accessed from this address. The P register is enabled by Pg,

$$Pg = \textcircled{\text{Kr}} Q2 \overline{T_s} Go \emptyset 0 \overline{I_a} \overline{O2} \overline{O3} + \dots$$

The new address is received by P1,

$$sP1 = \emptyset 0 \overline{I_a} \overline{O2} \overline{O3} \text{Add} + \dots$$

and Xz and Yz perform the indexing, if any.

$$Xz = X_n I_x \overline{F1} \overline{F3} \overline{T_s} + \dots$$

$$Yz = C23 \overline{F1} \overline{F3} + \dots$$

#### Instruction 40 (SKS)

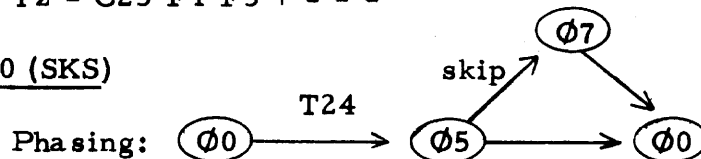

Instruction 40 advances directly to phase  $\emptyset 5$  at  $\emptyset 0 T24$ . During phase  $\emptyset 5$  the Sk (Skip) flip-flop will be set if Sks is true.

$$sSk = \emptyset 5 01 \overline{O4} T0 Sks + \dots$$

Sks will represent one of thirteen internal signals, or one of N external signals which have been specified by the instruction address.

$$\begin{aligned}
\text{Sks} &= + - - - \\
&+ (\text{C10 } \overline{\text{C11}}) \text{ C19 } \overline{\text{Ye}} \\
&+ (\text{C10 } \overline{\text{C11}}) \text{ C20 } \overline{\text{We}} \\
&+ (\text{C10 } \overline{\text{C11}}) \text{ C21 } \text{En} \\
&+ (\text{C10 } \overline{\text{C11}}) \text{ C22 } \overline{\text{En}} \\
&+ (\text{C10 } \overline{\text{C11}}) \text{ C23 } \overline{\text{Of}} \\
&+ (\overline{\text{C10}} \text{ C11}) \text{ Sio} \\
&+ (\text{C10 } \text{ C11}) \text{ Ssc} \\
&+ - - - - \\
&+ - - - -
\end{aligned}$$

Sio and Ssc represent external signals used for additional skip inputs. If Sk is set at T0, then the phase counter is advanced to phase  $\Phi 7$  to increment P again and perform the skip.

$$\begin{aligned}
\text{sF2} &= \text{Tp } \overline{\text{Ts}} \text{Sk} - - - + - - - \\
\text{sIa} &= \text{T24 } \Phi 7 \text{ Sk} \\
\text{rSk} &= \Phi 7 \text{ T0}
\end{aligned}$$

If Sk was not set, the phase counter will reset to phase  $\Phi 0$ .

$$\begin{aligned}
\text{rF1} &= \text{Tp End } \overline{\text{Sk}} \\
\text{rF3} &= \text{Tp End } \overline{\text{Sk}} \\
\text{rF2} &= \text{Tp End } \overline{\text{Sk}}
\end{aligned}$$

Instructions 50, 52, 53, 70, 72, 73 and 74

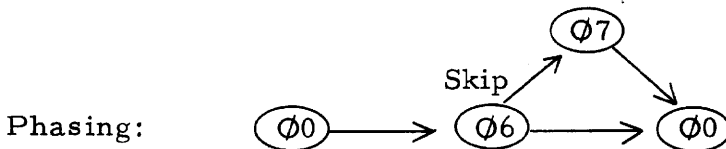

During phase  $\Phi 0$  of the above instructions the operand is accessed from memory in the usual manner, and then the phase counter is advanced to phase  $\Phi 6$ .

During phase  $\Phi 6$  the Sk flip-flop will determine if a skip is to occur.

Instruction 53 (SKN) will set the Sk flip-flop at T0 if the operand was negative.

$$\text{sSk} = 01 \overline{02} 03 \overline{04} 05 06 \Phi 6 \text{ T0 C23} + - - -$$

Note that the sign of the operand has been shifted to C23, by T0 time.

Instructions 50, 52, 70 and 72 preset the Sk flip-flop at T24 time.

$$\text{sSk} = 01 03 \overline{04} \overline{06} \Phi 6 \text{ T24} + - - -$$



Instruction 70 will reset Sk if the contents of A and C (operand) differ when B is a "one". Instruction 50 will reset Sk if A and C differ regardless of B.

$$\begin{aligned} rSk &= 01\ 03\ \overline{04}\ \overline{05}\ \overline{06}\ \emptyset 6\ \overline{T_p}\ \overline{T24}\ B_n\ (\overline{A_n}\ C23 + A_n\ \overline{C23}) + \dots \\ &+ 01\ 03\ \overline{04}\ \overline{05}\ \overline{06}\ \emptyset 6\ \overline{T_p}\ \overline{T24}\ \overline{02}\ (\overline{A_n}\ C23 + A_n\ \overline{C23}) + \dots \end{aligned}$$

If Sk is left in a set condition, then the skip will occur.

Instruction 72 or 52 will reset Sk if the operand and (A) or (B) compare "ones", respectively.

$$\begin{aligned} rSk &= 01\ 03\ \overline{04}\ \overline{05}\ \overline{06}\ \emptyset 6\ \overline{T_p}\ \overline{T24}\ C23\ A_n\ \overline{02} + \dots \\ &+ 01\ 03\ \overline{04}\ \overline{05}\ \overline{06}\ \emptyset 6\ \overline{T_p}\ \overline{T24}\ C23\ B_n\ \overline{02} + \dots \end{aligned}$$

Instruction 73 will set Sk if A has a "one" bit and C has a "zero" in the corresponding bit position; Sk will reset for the opposite condition. If 2 bits in corresponding bit positions in the registers compare, Sk remains in its current state. Since the sign bits have negative weights, the reverse logic applies at T0; and since the least significant bits arrive first, the final state of Sk is determined by which register contains the larger number.

$$\begin{aligned} sSk &= 01\ 02\ 03\ \overline{04}\ \overline{05}\ \overline{06}\ \emptyset 6\ \overline{T_p}\ \overline{T24}\ \overline{T0}\ A_n\ \overline{C23} \\ &+ 01\ 03\ \overline{04}\ \overline{05}\ \overline{06}\ \emptyset 6\ T0\ C23\ \overline{A_n} + \dots \\ rSk &= 01\ 03\ \overline{04}\ \overline{05}\ \overline{06}\ \emptyset 6\ \overline{T_p}\ \overline{T24}\ T0\ \overline{A_n}\ C23 \\ &+ 01\ 03\ \overline{04}\ \overline{05}\ \overline{06}\ \emptyset 6\ T0\ A_n\ \overline{C23} + \dots \end{aligned}$$

and a skip will or will not occur accordingly.

Instruction 74 sets Sk if the X register contains a one in bit 15. Since the new (X15) is required, Sk is set at T14 by Xw,

$$\begin{aligned} sSk &= Xnr\ 01\ 02\ 03\ 04\ \emptyset 6\ T14\ Xw + \dots \\ \text{where} \quad Xnr &= 01\ 02\ 03\ 04\ \overline{05}\ \overline{06}\ F1\ \overline{T_s} + \dots \\ \text{and} \quad sXw &= Xnr\ 01\ 02\ 03\ 04\ \overline{F3}\ Add \\ &+ Xnr\ 01\ 02\ 03\ 04\ F3\ (\overline{X_n}\ Sk + X_n\ Sk) + \dots \\ rSk &= \emptyset 7\ 01\ 02\ 03\ 04\ X_n\ \overline{T24} + \dots \end{aligned}$$

The adder outputs the difference of the B and C registers,

$$\begin{aligned} Xz &= B_n\ \emptyset 6\ 01\ 02\ 03\ 04 \\ Yz &= F1\ \overline{C23}\ \overline{06} \\ sCz &= \emptyset 6\ T24\ 04\ \overline{05}\ \overline{06} + \dots \end{aligned}$$

#### Instruction 41 (BRX)

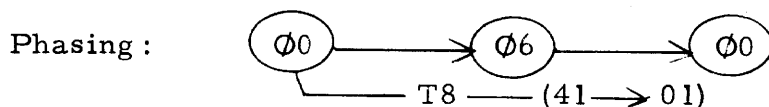

In phase Ø0 the address portion of the instruction is shifted into the P register through the adder as indexing may simultaneously take place.

$$sP1 = \overline{02}\ \overline{03}\ \emptyset 0\ \overline{I_a}\ Add + \dots$$

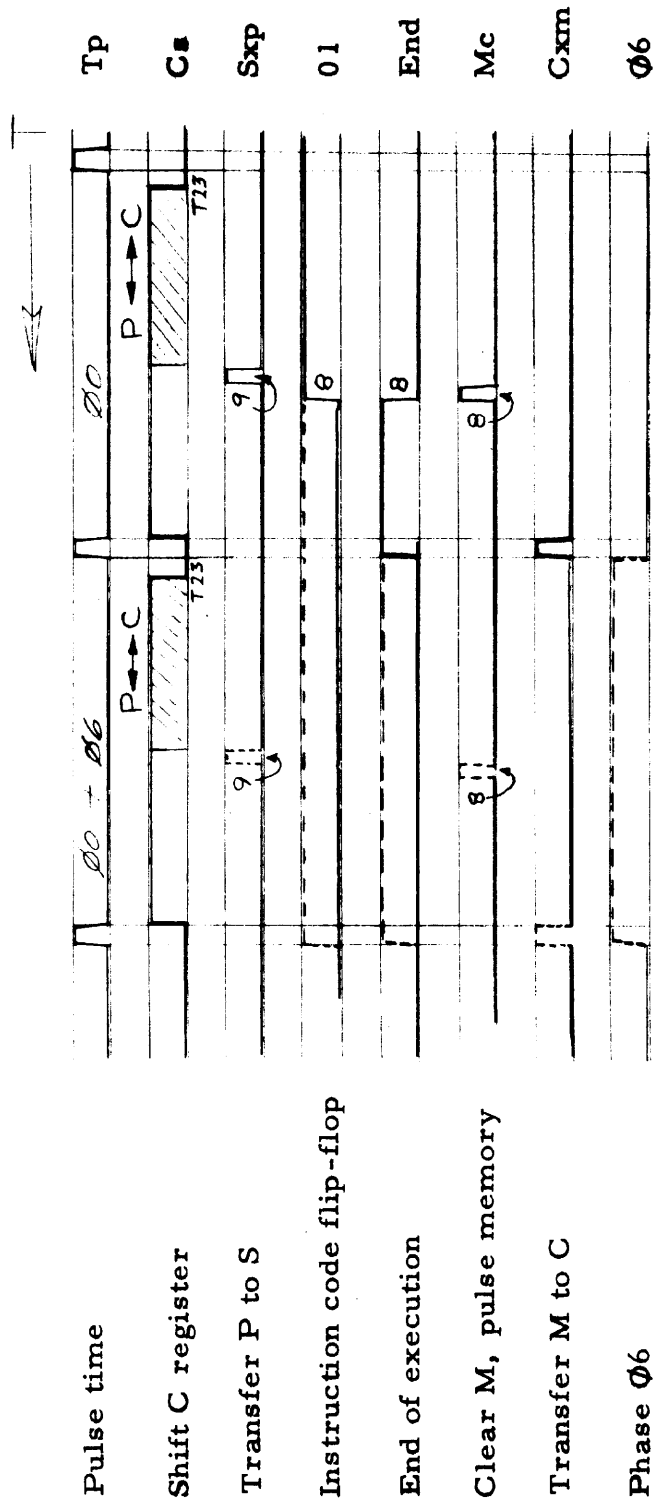

Note: Dashed lines indicate newly formed X9 bit is not a "one".

TIME  $\rightarrow$

FIGURE 17  
TIMING: INSTRUCTION 41 (BRX)

The previous number in P must be saved in case a transfer does not take place; therefore, it is shifted into the C register.

$$sC0 = \overline{02} \overline{03} \overline{00} \overline{Ia} P14 Q2$$

The X register is incremented during phase  $\overline{00}$  with  $\overline{Sk}$  being used as a carry in a half adder. Sk will come into  $\overline{00}$  in a reset state

$$sSk = 01 \overline{05} \overline{02} \overline{03} \overline{00} \overline{Ia} \overline{Xn} \overline{Tp} \overline{T24} \overline{T0} + - - -$$

$$rSk = \overline{00} T0 + - - -$$

$$sXw = 01 \overline{05} \overline{02} \overline{03} \overline{00} \overline{Ia} (\overline{Xn} \overline{Sk} + Xn Sk) + - - -$$

$$Xnr = \overline{00} \overline{Ia} \overline{02} \overline{03} 01 \overline{05} + - - -$$

Example :

$$Xn \quad 1 \ 0 \ 1 \ 0 \ 0 \ 1 \ 1$$

$$Sk \quad 1 \ 1 \ 1 \ 1 \ 0 \ 0 \ 0$$

$$sXw \ 1 \ 0 \ 1 \ 0 \ 1 \ 0 \ 0$$

At T9 the P register is transferred to S to access the instruction for branching. If the newly formed X9 bit is a "one", the branch will occur. The Xw flip-flop is gated at T8 to reset the 01 instruction code flip-flop. This changes the operation code from 41 to 01,

$$r01 = Xnr \overline{02} \overline{04} Xw Mc Q1 + Oc$$

where Mc is the pulse to the memory and occurs at T8.

If 01 is reset, the phase  $\overline{00}$  cycle becomes an End cycle since,

$$End = \overline{05} + \overline{06} + \overline{07} + \overline{00} \overline{Ia} \overline{01} \overline{02} \overline{03}$$

However, it becomes an End cycle too late for a possible interrupt operation. The X register also starts to recirculate (stops incrementing) and the carry into X normally does not go beyond X8. There is no carry beyond X8 unless X becomes positive, at which time the carry can extend to X0.

If 01 is not reset at T8  $\overline{00}$ , then the phase changes to  $\overline{06}$  at Tp and the instruction (41) continues operation.

$$sF1 = Tp \overline{Ia} \overline{00} 01 (\overline{04} + \overline{05}) + - - -$$

$$sF2 = Tp \overline{Ia} \overline{00} 01 \overline{02} + - - -$$

The C register is not altered at Tp; the word from memory is simply regenerated without being used.

During phase  $\overline{06}$  the original contents of P which were shifted to C must be shifted back to P and be incremented.

$$sIa = T24 F1 \overline{F3} \overline{Ij} + - - -$$

$$sP1 = 01 \overline{02} \overline{04} \overline{05} 06 \overline{06} (C23 \overline{Ia} + \overline{C23} Ia)$$

$$rIa = \overline{C23} \overline{06} 01 \overline{02} \overline{04} \overline{05} 06 \overline{T24} + - - -$$

At T9 this shift is completed and P is transferred in parallel to S to access the next instruction in sequence.

Instruction 43 (BRM)

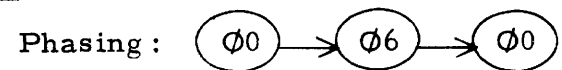

During phase  $\phi_0$  the contents of the P register are shifted to the C register for eventual storage,

$$sC_0 = \phi_0 \bar{I}_a \bar{O}_2 \bar{O}_3 P_{14} Q_2 + \dots$$

and the contents of the overflow flip-flop are shifted into C.

$$sC_0 = \phi_0 \bar{I}_a \bar{O}_2 \bar{O}_3 Of T_0 + \dots$$

$$C_s = \bar{T}_p \bar{T}_{24} \bar{F}_1 \bar{F}_2 + \dots$$

The address portion of the instruction is shifted into the P register.

$$P_g = \textcircled{Kr} Q_2 \bar{T}_s Go \phi_0 I_a \bar{O}_2 \bar{O}_3 + \dots$$

$$sP_1 = \phi_0 \bar{I}_a \bar{O}_2 \bar{O}_3 Add \bar{I}_{nt} + \dots$$

There may be indexing taking place. At  $T_9$  the new address in the P register is transferred to the S register to set up the address for storage.

$$S_{xp} = T_9 \bar{O}_2 \bar{O}_3 \bar{I}_a \phi_0$$

At  $T_p$  of  $\phi_0$  the M register is cleared, and at  $T_{24}$  the contents of the C register will be transferred to M for storage in core memory.

$$M_c = T_p \phi_0 \bar{I}_a \bar{O}_2 \bar{O}_3 O_5 + \dots$$

$$sP_0 = M_c T_p + \dots$$

$$M_{xc} = P_0 T_{24}$$

During phase  $\phi_6$  storage will take place, P will be incremented, and the next instruction accessed.

### Instruction 51 (BRR)

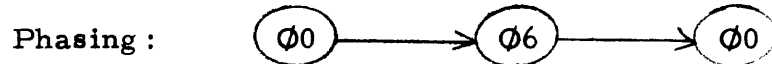

In phase  $\phi_0$  the contents of the memory location are accessed in the usual manner. The C register shifts through the adder around to itself for possible indexing. At  $T_{10}$  the S register is cleared; at  $T_9$  the upper part of the C register is transferred in parallel to S ( $S_{xc}$ ); and at  $\phi_0 T_p$  the M register is transferred to C, ( $C_{xm}$ ) and the phase changes to phase  $\phi_6$ .

During phase  $\phi_6$  the operand, in C, shifts to the P register. The  $I_a$  flip-flop is preset and increments the contents of C as it shifts to P.

$$sI_a = T_{24} F_1 \bar{F}_3 \textcircled{I_j} + \dots$$

$$rI_a = \bar{C}_{23} \phi_6 O_1 \bar{O}_2 \bar{O}_4 \bar{O}_5 O_6 \bar{T}_{24} + T_0 F_1 + \dots$$

$$sP_1 = \phi_6 O_1 \bar{O}_2 \bar{O}_4 \bar{O}_5 O_6 (C_{23} \bar{I}_a + \bar{C}_{23} I_a)$$

The contents of  $C_0$  are stored in the overflow flip-flop (true side only)

$$sOf = \phi_6 O_1 \bar{O}_2 O_3 \bar{O}_4 \bar{O}_5 O_6 C_0 T_{24} + \dots$$

At  $T_{10}$  the S register is cleared; at  $T_9 \phi_6$  the new contents of P are transferred to S to access the memory for the next instruction. At  $T_p \phi_6$  the next instruction is brought from memory and this instruction ends. The phase counter is reset to phase  $\phi_0$ .

$$C_{xm} = T_p End Go + \dots$$

$$rF_1 = rF_2 = rF_3 = T_p End \bar{S}_k$$

## MEMORY INCREMENT INSTRUCTIONS

### Instructions 60 and 61



During phase  $\emptyset 0$  the operand to be incremented will be accessed from memory in the usual manner and indexing or indirect addressing may occur.

The phase counter is then advanced to phase  $\emptyset 4$  and C is shifted to the right one cycle time.

$$Cs = \overline{T_p} \overline{T_{24}} F_1 \overline{F_3} + \dots$$

The incrementing is performed by using Cz (carry flip-flop) in a half adder and the sum is returned to C0,

$$sC_0 = \emptyset 4 \ 01 (\overline{C_{23}} C_z + C_{23} \overline{C_z}) \overline{05} + \dots$$

$$sC_z = 01 \overline{05} \emptyset 4 T_{24} + \dots$$

$$rC_z = \overline{F_3} \overline{T_{24}} \overline{X_z} \overline{Y_z} C_z \overline{T_s} + \dots$$

where

$$Y_z = F_1 C_{23} 06 + F_1 \overline{C_{23}} \overline{06} + \dots$$

If the instruction code is (61), then the Yz input will represent C23 and Cz will be reset the first time C23 is false. Therefore, the operand is incremented by (+ 1).

If the instruction code is 60, Cz will be reset the first time C23 is true and the operand will be decremented by 1.

### Example (61)

$$\begin{array}{r} C_{23} \quad 1 \ 1 \ 0 \ 1 \ 0 \ 1 \ 1 \ 1 \\ C_z \quad \quad 0 \ 0 \ 0 \ 0 \ 1 \ 1 \ 1 \ 1 \\ \hline sC_0 \quad 1 \ 1 \ 0 \ 1 \ 1 \ 0 \ 0 \ 0 \end{array}$$

An overflow can occur during this arithmetic operation.

$$sOf = \overline{03} \emptyset 4 T_0 (\overline{05} + 06) [\overline{X_z} \overline{Y_z} C_z] + \dots$$

During phase  $\emptyset 7$  the operand is transferred from C to M by Mxc,

$$Mxc = T_{24} P_0$$

and is stored in memory.

Instruction 60 can set Sk during  $\emptyset 4$  if C is negative:

$$sSk = 01 \overline{05} \overline{06} \emptyset 4 T_p C_0$$

Sk being set will cause P to be incremented in phase  $\emptyset 7$  as well as in phase  $\emptyset 4$  to force a skip.

## STORE INSTRUCTIONS

### Instructions 35, 36, 37

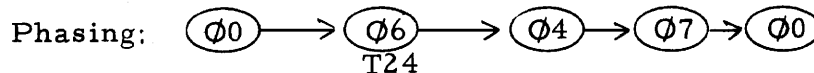

During phase  $\emptyset 0$  the address is shifted through the adder for possible indexing, and at T9 is transferred (Sxc) to the S register to address the store location.

The phase counter advances to phase  $\Phi 6$  for one pulse time and is reset to phase  $\Phi 4$ . During phase  $\Phi 4$  the information to be stored is shifted into the C register.

$$Cs = \overline{Tp} \overline{T24} F1 \overline{F3} + - - -$$

Instructions 35, 36 and 37 store the contents of the A, B and X registers, respectively.

$$\begin{aligned} sC0 &= \Phi 4 \ 04 \ 05 \ 06 \ Xn \\ &+ \Phi 4 \ 04 \ \overline{05} \ 06 \ An \\ &+ \Phi 4 \ 04 \ 05 \ \overline{06} \ Bn \end{aligned}$$

During  $\Phi 4$ , the P register is incremented.

$$\begin{aligned} sIa &= T24 \ F1 \ \overline{F3} \ \textcircled{I} + - - - \\ Pg &= \textcircled{Kr} \ Q2 \ \overline{Ts} \ Go \ F1 \end{aligned}$$

During  $\Phi 7$ ,  $\overline{Sk}$  prevents a second increment by blocking the setting of Ia.

At the completion of phase  $\Phi 4$  the counter advances to phase  $\Phi 7$  and the information will be transferred to the M register and stored.

### LOAD INSTRUCTIONS

Instructions            71, 75, 76 and 77

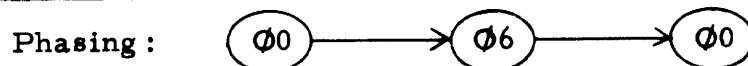

During phase  $\Phi 0$  the operand is accessed in usual fashion and transferred to the C register at  $Tp$ . During phase  $\Phi 6$  the operand is shifted into the designated registers depending upon the instruction code.

$$Cs = \overline{Tp} \overline{T24} F1 \overline{F3} + - - -$$

For Instruction 71 (LDX):

$$\begin{aligned} sXw &= Xnr \ 01 \ 03 \ \overline{04} \ \Phi 6 \ C23 + - - - \\ Xnr &= 01 \ 03 \ \overline{04} \ \Phi 6 \ 02 \ \overline{05} \ 06 + - - - \end{aligned}$$

For Instruction 75 (LDB):

$$\begin{aligned} sBw &= Bnr \ 03 \ C23 + - - - \\ Bnr &= 01 \ 02 \ 03 \ 04 \ \overline{05} \ 06 \ \Phi 6 \end{aligned}$$

For Instruction 76 (LDA):

$$\begin{aligned} sAw &= Anr \ 01 \ 02 \ 03 \ 04 \ C23 \\ Anr &= 01 \ 02 \ 03 \ 04 \ 05 \ \overline{06} \ \Phi 6 + - - - \end{aligned}$$

Instruction 77 causes the effective address of the instruction to be shifted through the adder and into the X register during phase  $\Phi 0$ .

$$\begin{aligned} sXw &= Xnr \ 01 \ 02 \ 03 \ 04 \ \overline{F3} \ Add + - - - \\ Xnr &= 01 \ 02 \ 03 \ 04 \ 05 \ 06 \ \overline{Ia} \ \Phi 0 \ Q2 \end{aligned}$$

The input to the adder is as usual during phase  $\Phi 0$ .

During phase  $\Phi 6$  the P register is incremented, and at  $Tp$  the phase counter is reset to phase  $\Phi 0$ .

## INPUT INSTRUCTIONS

### Instruction 30 (YIM) and 32 (WIM)

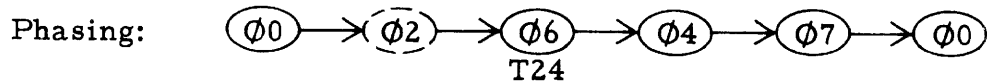

During phase  $\Phi 0$  the operand is accessed in the normal fashion and transferred to the C register at  $T_p$  (although it will not be used). At  $T_p \Phi 0 \bar{I}_a$  the F2 flip-flop is set for either phase  $\Phi 2$  or phase  $\Phi 6$ .

$$sF2 = T_p \bar{I}_a \Phi 0 \ 03$$

$$rF2 = T24 \ \Phi 6 \ \bar{01} \ 02 \ 03 \ + \ - \ - \ -$$

If the Buffer (W or Y) is ready to receive data, the "Ready" flip-flop Rf is set either during phase  $\Phi 0$  or phase  $\Phi 2$ .

$$sRf = \bar{T}_s \ \bar{01} \ 03 \ \bar{04} \ \bar{I}_a \ \bar{F1} \ \bar{F3} \ [ \bar{W}f (W0 + \bar{W}9) \ 05 \ \bar{06}$$

$$+ \ \textcircled{Yf (Y0 + Y9)} \ \bar{05} ]$$

$$rRf = T_p \text{ End } \bar{SK}$$

The W and Y terms are buffer terms which signal that the respective buffer is ready to transfer a new word to memory. The F1 flip-flop is set forming phase  $\Phi 6$  only if Rf is set.

$$sF1 = \bar{T}_s \ T_p \ \bar{01} \ 03 \ \bar{I}_a \ \bar{F1} \ \bar{F3} \ Rf \ \bar{04} \ + \ - \ - \ -$$

At  $\Phi 6$  T24 the F2 flip-flop is reset and the phase changes to phase  $\Phi 4$ . During phase  $\Phi 4$  the buffer is shifted into the C register.

$$Cs = F1 \ \bar{F3} \ \bar{T}_p \ \bar{T24} \ + \ - \ - \ -$$

$$sC0 = \Phi 4 \ \bar{01} \ \bar{04} \ \bar{05} \ \textcircled{Y_n}$$

$$+ \ \Phi 4 \ \bar{01} \ \bar{04} \ \bar{05} \ \bar{06} \ W_n$$

The address in the S register is not altered and the word in memory is interrogated again. Mc clears the memory register (M) at  $T_p$ ,

$$Mc = T_p \ \Phi 4 \ + \ - \ - \ -$$

and P0 remembers to write in the memory.

$$sP0 = Mc \ T_p$$

$$rP0 = P0 \ T24$$

$$Mxc = P0 \ T24$$

During phase  $\Phi 4$  the P register is incremented. At  $\Phi 4$   $T_p$  the phase counter changes to phase  $\Phi 7$ . During phase  $\Phi 7$  the data is generated in the memory and the next instruction is accessed.

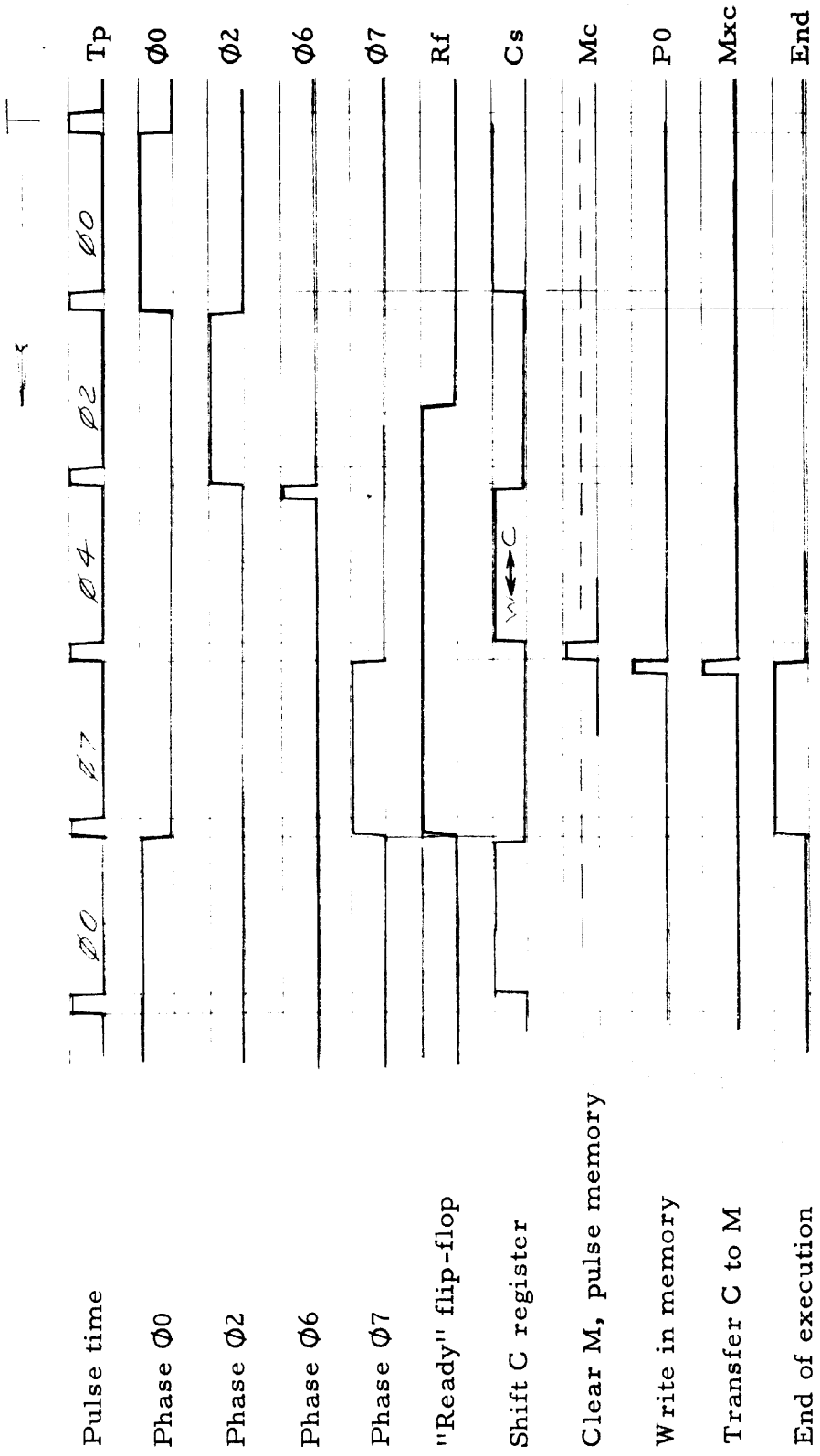
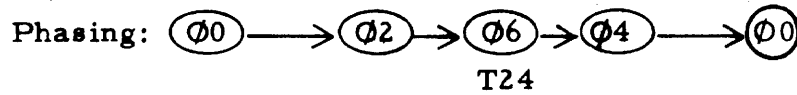

FIGURE 18  
TIMING: INSTRUCTION 30, 32



## Instruction 33 (PIN)



During phase  $\emptyset 0$  the storage address is transferred to the S register in the usual fashion.

The phase counter then advances to phase  $\emptyset 2$ , as this phase cannot be by-passed on instruction code 33. This allows at least one cycle time for the parallel input transfer to occur. The ready flip-flop Rf is not set until phase  $\emptyset 2$ , where Rt is the appropriate external ready signal for input.

$$\begin{aligned} sRf &= \overline{01} 03 \overline{1a} \overline{F1} \overline{F3} \overline{T_s} \emptyset 2 06 Rt Q2 \overline{04} + - - - \\ rRf &= T_p \text{End } \overline{S_k} \end{aligned}$$

During phase  $\emptyset 2$  a signal designated Pin is generated to indicate that the input lines are being strobed.

$$\text{Pin} = \text{Cxi } Q1$$

F1 will not be set to advance to phase  $\emptyset 6$  until the Rf flip-flop is set.

$$sF1 = \overline{T_s} T_p \overline{01} 03 \overline{1a} \overline{F1} \overline{F3} Rf \overline{04} + - - -$$

The external information is transferred in parallel to the C register via lines Cd0, Cd1, - - - Cd23. These are gated by:

$$\begin{aligned} \text{Cxi} &= 02 06 \emptyset 2 \\ \text{Cg} &= \text{Cxi } Q1 + - - - \end{aligned}$$

During phase  $\emptyset 4$  the C register shifts around to itself and parity is generated and a completion signal, Rti, is also generated.

$$\begin{aligned} \text{Cs} &= \overline{T_p} \overline{T24} F1 \overline{F3} + - - - \\ \text{Cg} &= \text{Cs} + - - - \\ sC0 &= (\emptyset 4 \overline{01}) \overline{04} 06 C23 + - - - \\ sC24 &= (T22 - T_p) C0 \overline{C24} \\ rC24 &= T23 + (T22 - T_p) C0 C24 + \textcircled{\text{St}} \\ \text{Rti} &= \emptyset 4 \overline{01} \overline{04} 06 \end{aligned}$$

During phase  $\emptyset 4$  the P register is incremented and during phase  $\emptyset 7$  the information is generated in memory.

## OUTPUT INSTRUCTIONS

### Instructions 10 (MIY) and 12 (MIW)

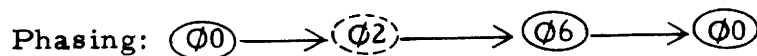

During phase  $\emptyset 0$ , the operand is accessed in the normal fashion and transferred to the C register. At  $T_p \emptyset 0 \overline{1a}$ , the F2 flip-flop is set for either phase  $\emptyset 2$  or phase  $\emptyset 6$ .

$$sF2 = (T_p \overline{1a} \emptyset 0) 03 + - - -$$

If the buffer is ready to receive a new word, the ready flip-flop Rf is set during either phase  $\Phi 0$  or  $\Phi 2$ .

$$sRf = \overline{T_s} \overline{01} \overline{03} \overline{04} \overline{I_a} \overline{F1} \overline{F3} \left[ \overline{Wf} (W0 + \overline{W9}) \overline{05} \overline{06} + \overline{Yf} (Y0 + \overline{Y9}) \overline{05} \right] + \dots$$

$$rRf = T_p \text{ End } \overline{Sk}$$

Therefore, if the buffer is ready before the instruction is given, phase  $\Phi 2$  is not reached and the phase counter goes directly to phase  $\Phi 6$ . If the buffer is not ready, the computer remains in phase  $\Phi 2$  until Rf is set by the buffer. In phase  $\Phi 2$  the C register does not shift.

During phase  $\Phi 6$  the C register is shifted into the W or Y Buffer registers. At  $T_p$  the phase counter is reset to phase  $\Phi 0$ .

### Instruction 13 (POT)



During phase  $\Phi 0$  the operand is accessed in the normal fashion and transferred to the C register at  $T_p$ . During instruction 13 phase  $\Phi 2$  cannot be by-passed, even if the external buffer is ready. This allows at least one cycle time for the parallel output transfer to occur. The ready flip-flop Rf is not set until phase  $\Phi 2$ .

$$sRf = \overline{01} \overline{03} \overline{04} \overline{F1} \overline{F3} (\overline{\Phi 2} \overline{06} R_t \overline{Q2}) \overline{I_a} \overline{T_s} + \dots$$

$$rRf = T_p \text{ End } \overline{Sk}$$

$R_t$  is the appropriate external ready signal for output.

During phase  $\Phi 2$  two signals are generated for external use. Pot 1 indicates that the information is being presented. Pot 2 can be used as a "strobe" signal for setting external flip-flops.

$$\text{Pot 1} = \overline{F1} F2 \overline{F3} \overline{T_s} \overline{02} \overline{06}$$

$$\text{Pot 2} = \overline{\Phi 2} \overline{02} \overline{06} Q1$$

F1 will not be set for advancing to phase  $\Phi 6$  until the Rf flip-flop is set.

$$sF1 = \overline{T_s} T_p \overline{01} \overline{03} \overline{I_a} \overline{F1} \overline{F3} R_f \overline{04} + \dots$$

Memory parity for the output data is checked during  $\Phi 6$ .

$$sCp = \overline{C_p} C23 \overline{H_t} \overline{T_p} \overline{T24} (\overline{03} \overline{\Phi 6} + \dots) + \dots$$

$$rCp = C_p C23 \overline{H_t} \overline{T_p} \overline{T24} (\overline{03} \overline{\Phi 6} + \dots) + \dots$$

During phase  $\Phi 6$  the P register is incremented and at  $T_p$  the phase counter is reset to phase  $\Phi 0$ .

### CONTROL INSTRUCTIONS

#### Instruction 23 (EXU)



During phase  $\Phi 0$  the address of the instruction is shifted through the adder for possible indexing and at  $T_9$  transferred ( $S_{xc}$ ) to the S register to access the instruction to be executed.

At  $T_p$  the O register is reset.

$$O_c = \overline{01} \overline{03} \overline{05} T_p \overline{I_a} + \dots$$

The P register is not affected and will be incremented by the accessed instruction in the normal fashion. The phase counter remains in phase  $\Phi 0$ .

## Instructions 00, 02, and 20

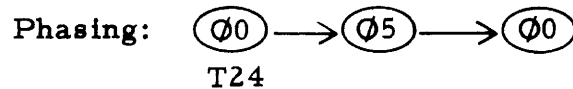

The phase counter remains in phase  $\emptyset 0$  for only one pulse time and then advances to phase  $\emptyset 5$ . The C register does not shift during phase  $\emptyset 5$ . Instruction 00 (HLT) sets the Ht flip-flop during phase  $\emptyset 5$  to initiate a halt,

$$sHt = \emptyset 5 \overline{T0} \overline{T1} \overline{T2} \overline{T5} \overline{Int} + \dots$$

and at  $Tp \emptyset 5$  the computer will halt.

$$rGo = Tp \text{ End } \overline{Sk} \text{ Ht} + \dots$$
$$\text{End} = F1 F3 \overline{T_s} + \dots$$

Instruction 02 (EOM) activates Eom signals to external devices and/or to the W Buffer during phase  $\emptyset 5$ .

$$Eom = \emptyset 5 \overline{T1} \emptyset 5$$
$$Sys = \emptyset 5 \overline{T1} \emptyset 5 \overline{C9} C10 C11 Q1$$
$$Ioc = \emptyset 5 \overline{T1} \emptyset 5 \overline{C10} C11 Q1$$
$$Buc = \emptyset 5 \overline{T1} \emptyset 5 \overline{C10} \overline{C11}$$

where:

Sys = Systems communications  
Ioc = Input/output control  
Buc = Buffer control

Instruction 20 (NOP) does not cause any special operation to occur in phase  $\emptyset 5$  and all registers recirculate as normal.

The P register is incremented during phase  $\emptyset 5$  and the next instruction is accessed.

## LOGICAL INSTRUCTIONS

### Instructions 14, 16, and 17



During phase  $\emptyset 0$  the operand is accessed in the normal fashion and at  $Tp$  the phase counter is advanced to phase  $\emptyset 6$ .

During phase  $\emptyset 6$  the C register will be shifted right and logical operations performed as it enters the A register.

$$Cs = \overline{Tp} \overline{T24} F1 \overline{F3} + \dots$$

Instruction 14 (ETR) causes the contents of the A register and the operand to be "ANDED" together.

$$sAw = \overline{01} \overline{02} 03 04 \overline{06} \emptyset 6 \text{ An } C23$$

$$\text{Anr} = \overline{02} 03 04 \emptyset 6 + - - -$$

Instruction 16 (MRG) causes the contents of the A register and the operand to be "inclusively OR'd" together.

$$sAw = \overline{01} \overline{02} 03 04 \overline{06} \emptyset 6 \text{ An } C23$$

$$+ \overline{01} \overline{02} 03 04 05 \emptyset 6 \text{ An } \overline{C23}$$

$$+ \overline{01} \overline{02} 03 04 05 \emptyset 6 \overline{\text{An}} C23$$

$$+ - - -$$

Instruction 17 (EOR) causes the contents of the A register and the operand to be "exclusively OR'd" together.

$$sAw = \overline{01} \overline{02} 03 04 05 \emptyset 6 \text{ An } \overline{C23}$$

$$+ \overline{01} \overline{02} 03 04 05 \emptyset 6 \overline{\text{An}} C23$$

$$+ - - -$$

At  $\emptyset 6$  Tp the phase counter is reset to phase  $\emptyset 0$ .

### REGISTER CHANGE INSTRUCTIONS

#### Instruction 46

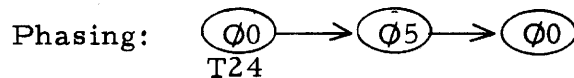

The phase counter advances to phase  $\emptyset 5$  after one pulse time. During phase  $\emptyset 5$  certain transfers will take place between the A, B and X registers under the control of the C register. (see page 1.12)

C20 causes  $(B) \rightarrow A$ , C16 causes  $(X) \rightarrow A$ , C23 causes A to be cleared and C14 causes  $-(A) \rightarrow A$ .

$$sAw = (\overline{02} \overline{03} 04 \overline{\text{Ts}}) \text{ Bn } C20$$

$$+ (\overline{02} \overline{03} 04 \overline{\text{Ts}}) \text{ Xn } C16$$

$$+ (\overline{02} \overline{03} 04 \overline{\text{Ts}}) C14 (\text{An } \overline{P0} + \overline{\text{An}} P0)$$

$$+ - - -$$

$$\text{Anr} = (\overline{02} \overline{03} 04 \overline{\text{Ts}}) (C20 + C16 + C14 + C23)$$

In the last term P0 is used to aid in getting a two's complement of A.

$$sP0 = \overline{02} \overline{03} 04 \overline{\text{Ts}} \overline{\text{Tp}} \overline{\text{T0}} \text{ An } + - - -$$

$$rP0 = \overline{02} \overline{03} 04 \overline{\text{Ts}} \text{ T0 } + P0 \text{ T24 } + \textcircled{\text{St}}$$

For the B register:

$$sBw = (\overline{02} \overline{03} 04 \overline{\text{Ts}}) \text{ An } C21$$

$$+ (\overline{02} \overline{03} 04 \overline{\text{Ts}}) \text{ Xn } C18$$

$$+ - - -$$

and 
$$\text{Bnr} = (\overline{02} \overline{03} 04 \overline{\text{Ts}}) (C22 + C21 + C18) + - - -$$

For the X register:

$$sXw = (\overline{02} \overline{03} 04 \overline{T_s}) C19 Bn + - - -$$

$$(\overline{02} \overline{03} 04 \overline{T_s}) C15 An + - - -$$

$$Xnr = (\overline{02} \overline{03} 04 \overline{T_s}) (C15 + C19) + - - -$$

If C17 is set, only 9 bits of the register exchange is performed. C17 resets the C register, thereby stopping the exchange.

$$Cg = (\overline{02} \overline{03} 04 \overline{T_s}) Q1 Q4 C17 + - - -$$

If the index register was involved in the exchange, the Ix flip-flop is set.

$$sIx = (\overline{02} \overline{03} 04 \overline{T_s}) Q1 Q4 C17 Xnr + - - -$$

This will cause the contents of bit X15 to be extended in the index register to all bit positions to the left of X15.

$$Xnr = (\overline{02} \overline{03} 04 \overline{T_s}) Ix + - - -$$

$$sXw = (\overline{02} \overline{03} 04 \overline{T_s}) Ix Xw \overline{T23} + - - -$$

$$rIx = T_p \overline{Mh} + - - -$$

## SHIFT INSTRUCTIONS

### Instruction 66

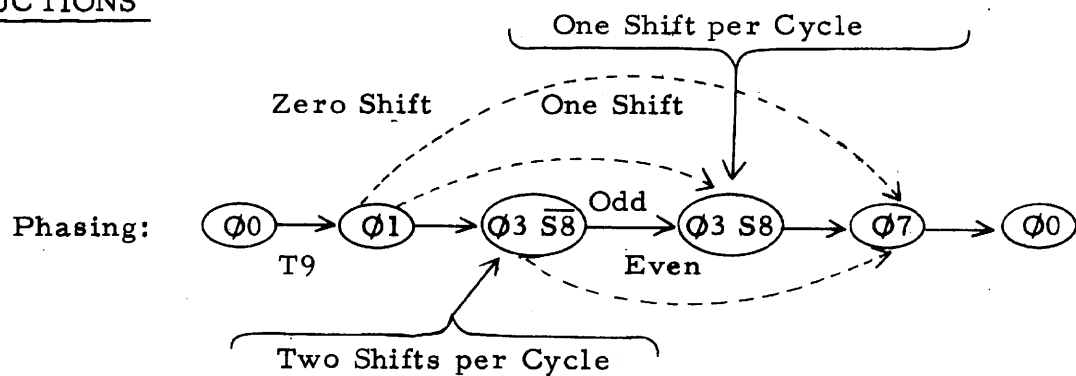

During phase 00 indexing may proceed as usual but only from T23 to T16 (8 bit times). The Ix flip-flop is reset at T16 so that indexing will not modify the instruction modifiers originally in bits C10 and C11. The instruction modifier (C10) determines if the operation is to be a right shift or a right cycle.

$$66 \underline{2} 00XX \text{ (Right Cycle) RCY}$$

$$66 \underline{0} 00XX \text{ (Right shift) RSH}$$

Bit C10 will ultimately be transferred to S1. The carry flip-flop is also forced off when Ix is off to prevent a carry into this bit position.

$$rIx = (\overline{00} \overline{I_a} 02 \overline{03} 04) 05 Q1 + - - -$$

$$rCz = \overline{00} \overline{I_x} \overline{T_p} + - - -$$

The adder continues to feed C0 but after T15 its output must be the same as C23. At T10 the S register is cleared as usual during phase 00.

$$Sc = T10 \overline{T_s} \overline{F1} \overline{F2} + - - -$$

At T9 the C register is transferred to the S register,

$$s_{xc} = T9 \overline{\phi}0 \overline{P0} (Ia + 03 + 02) + \dots$$

and at the same time the phase is changed to phase  $\phi 1$ .

$$s_{F3} = T9 05 \overline{Ia} \overline{\phi}0 02 \overline{03} 04 + \dots$$

The memory is not pulsed at T8 by Mc because of phase  $\phi 1$ . Therefore, the S register does not have to remain constant and it will count down the number of shifts required. The 920 counts by two's; S14 is not part of the counter.

The shift right is accomplished by shortening the recirculation paths of the A and B registers. Ar feeds Aw directly, by-passing Ae and An. This causes a right shift of two bit positions per cycle. The two least significant bits of A are held in Ae and An during the cycle time and then deposited in the most significant positions of B.

$$s_{Bw} = \overline{\phi}3 05 \overline{06} Br \overline{S8} \overline{T0} \overline{T1} \overline{Mh}$$

$$+ \overline{\phi}3 05 \overline{06} An (\overline{S8} T1 + T0)$$

$$Bnr = \overline{\phi}3$$

$$s_{Ae} = Ar \left[ \overline{\phi}3 05 \overline{06} (Q1 + Q2 + S8 \overline{Q3}) \right] + Ar S8$$

$$r_{Ae} = \overline{Ar} \left[ \overline{\phi}3 05 \overline{06} (Q1 + Q2 + S8 \overline{Q3}) \right] + \overline{Ar} S8$$

$$s_{An} = Ae \left[ \overline{\phi}3 05 \overline{06} (Q1 + Q2 + S8 \overline{Q3}) \right]$$

$$r_{An} = \overline{Ae} \left[ \overline{\phi}3 05 \overline{06} (Q1 + Q2 + S8 \overline{Q3}) \right]$$

The above logic causes Ae and An to read Ar and Ae, respectively, during T1, T0, Tp, T24 during  $\overline{S8} \overline{\phi}3$  of the right shift (66) command. Therefore, they pick up the two least significant bits each cycle time and hold them for the B register.

The A register shifts:

$$s_{Aw} = \overline{\phi}3 05 \overline{06} Ar \overline{S8} (\overline{T1} \overline{T0}) + \dots$$

$$Anr = \overline{\phi}3 + \dots$$

The S1 flip-flop which contains the bit originally from C10 controls the mode of shifting:

$$s_{Aw} = \overline{\phi}3 05 \overline{06} (T1 \overline{S8} + T0) \overline{S1} Aw \text{ (sign extends)}$$

$$+ \overline{\phi}3 05 \overline{06} (T1 \overline{S8} + T0) S1 Bn \overline{S3} \text{ (cycle)}$$

$$+ \dots$$

Bn and Be hold the least significant bits from the B register.  $\overline{S3}$  is in the gate so that a right shift command 66 2 4 0 XX will cause a right shift forcing zeros into the most significant positions of A rather than extending the sign of A or cycling information from B.

S13 through S9 form a binary counter and count down one for each cycle of  $\overline{S8} \overline{\phi}3$ . The Ss amplifier causes the count:

$$Ss = \overline{\phi}3 T23 \overline{Mh}$$

where  $\overline{Mh}$  is false only during multiplication.

When the counter reaches zero, one of two alternatives exist. If the number of shifts required were even, as indicated by S14 then the shifting is complete. The phase counter is forced to phase  $\Phi 7$  by the Sk flip-flop.

$$sSk = \overline{F1} F3 \overline{T_s} 05 \overline{S9} \overline{S10} \overline{S11} \overline{S12} \overline{S13} \overline{S14} T0$$

$$sF1 = sF2 = sF3 = T_p \overline{T_s} S_k$$

If the required number of shifts were odd, then S8 is set and a single right shift occurs during  $\Phi 3$  S8.

$$sS8 = \overline{F1} F3 \overline{T_s} T_p \overline{S9} \overline{S10} \overline{S11} \overline{S12} \overline{S13} (04 \overline{05} \overline{06})$$

and with S8:

$$sAw = \Phi 3 05 \overline{06} Ae S8 \overline{T0}$$

$$sBw = \Phi 3 05 \overline{06} Be S8 \overline{T0}$$

$\Phi 3$  S8 can only last one cycle since Sk is set and forces phase  $\Phi 7$ .

$$sSk = \Phi 3 T0 S8$$

During phase  $\Phi 7$ , Sk causes Ia to be set to increment the P register. At T9  $\Phi 7$ , P is transferred to S and at  $\Phi 7$  Tp the next instruction is transferred from M to C and the phase counter returns to  $\Phi 0$ .

### Instruction 67

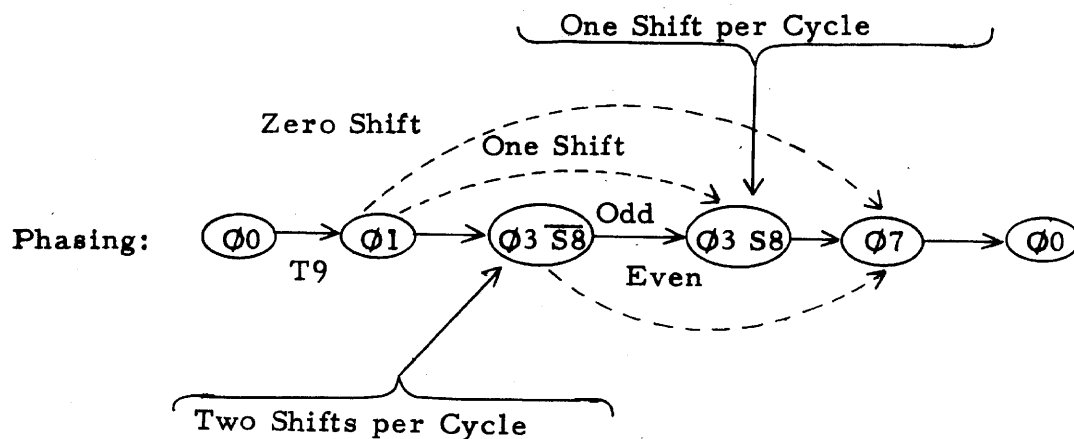

During phase  $\Phi 0$  indexing is performed from T23 to T16 (8 bit times). The Lx flip-flop is reset at T16 so that indexing will not modify the instruction modifiers in bits C10 and C11.

6 7 2 00 XX (Left Cycle) LCY

6 7 0 00 XX (Left Shift) LSH

6 7 1 00 XX (Normalize) NOD

At  $\Phi 0$  T10 the S register is cleared and at T9 the C register containing the shift count and the shift mode is transferred to S. Also at T9  $\Phi 0$  the phase counter is advanced to phase  $\Phi 1$ .

$$sF3 = T9 05 \Phi 0 \overline{Ia} 02 \overline{03} 04$$

The memory is not cycled during phase  $\Phi 1$  or  $\Phi 3$  since the memory pulse Mc is inhibited. This leaves the S register free to count and to aid in the shifting. At Tp  $\Phi 1$  the phase counter advances to  $\Phi 3 \overline{S8}$ , ( $\Phi 3$  S8 if the count was one,  $\Phi 7$  if the count was zero).

During  $\Phi 3 \overline{S8}$  the A and B registers shift left two bits per cycle time. This is accomplished by delaying or lengthening the recirculation paths of these registers. S4 and S5 are inserted between An and Aw.

$$\begin{aligned} sS4 &= (\Phi 3 \ 05 \ 06 \ \overline{T0} \ \overline{Tp} \ \overline{T24}) \ An + \ - \ - \ - \\ rS4 &= (\Phi 3 \ 05 \ 06 \ \overline{T0} \ \overline{Tp} \ \overline{T24}) \ \overline{An} + \ - \ - \ - \\ sS5 &= (\overline{F1} \ F3 \ \overline{Ts} \ 05 \ 06 \ \overline{T24}) \ S4 + \ - \ - \ - \\ rS5 &= (\overline{F1} \ F3 \ \overline{Ts} \ 05 \ 06 \ \overline{T24}) \ \overline{S4} + \ - \ - \ - \\ sAw &= \Phi 3 \ 05 \ 06 \ S5 \ \overline{S8} \\ Anr &= \Phi 3 \end{aligned}$$

S6 and S7 are similarly inserted between Bn and Bw to shift B left two bits per cycle. The most significant bits of B must be shifted into the least significant positions of A. S4 and S5 pick up the most significant bits of B on the previous cycle:

$$\begin{aligned} sS4 &= [\overline{F1} \ F3 \ 05 \ 06 \ \overline{Ts} \ \overline{Q1} \ \overline{Q2} \ Q5] \ Bw + \ - \ - \ - \\ rS4 &= [\overline{F1} \ F3 \ 05 \ 06 \ \overline{Ts} \ \overline{Q1} \ \overline{Q2} \ Q5] \ \overline{Bw} + \ - \ - \ - \\ sS5 &= [\overline{F1} \ F3 \ \overline{Ts} \ 05 \ 06 \ \overline{T24}] \ S4 + \ - \ - \ - \\ rS5 &= [\overline{F1} \ F3 \ \overline{Ts} \ 05 \ 06 \ \overline{T24}] \ \overline{S4} + \ - \ - \ - \end{aligned}$$

In a similar manner S6 and S7 pick up the most significant bits of the A register for left cycle.

$$\begin{aligned} sS6 &= [\overline{F1} \ F3 \ \overline{Ts} \ 05 \ 06 \ \overline{Q1} \ \overline{Q2} \ Q5] \ AwS1 + \ - \ - \ - \\ rS6 &= [\overline{F1} \ F3 \ \overline{Ts} \ 05 \ 06 \ \overline{Q1} \ \overline{Q2} \ Q5] \ \overline{AwS1} + \ - \ - \ - \\ &+ [\overline{F1} \ F3 \ \overline{Ts} \ 05 \ 06 \ \overline{Q1} \ \overline{Q2} \ Q5] \ \overline{S1} + \ - \ - \ - \end{aligned}$$

The last term resets S6 and S7 to insert zeros into the least significant bits of B in the left shift mode.

The overflow flip-flop is set if a bit different from the sign bit is shifted into or beyond the sign position of A in the left shift mode.

$$\begin{aligned} sOf &= \Phi 3 \ 05 \ 06 \ \overline{S1} \ T0 \ \overline{S8} \ (An \ \overline{S5} + \ \overline{An} \ S5) \\ &+ \Phi 3 \ 05 \ 06 \ \overline{S1} \ T0 \ (\overline{An} \ S4 + \ An \ \overline{S4}) + \ - \ - \ - \end{aligned}$$

S9 through S13 form a counter and count down one each cycle time.

$$Ss = \Phi 3 \ T23 \ \overline{Mh}$$

When this counter reaches zero, the phase counter changes to  $\Phi 3 \ S8$  if S14 is set for an odd number of shifts.

$$sS8 = \overline{F1} \ F3 \ \overline{Ts} \ Tp \ \overline{S9} \ \overline{S10} \ \overline{S11} \ \overline{S12} \ \overline{S13} \ (04 \ 05 \ 06)$$

Here  $\overline{F1} \ F3 \ \overline{Ts}$  is used rather than  $\Phi 3$  because if the original shift count was one, the phase must step from  $\Phi 1$  directly to  $\Phi 3 \ S8$ .

In phase  $\Phi 3 \ S8$  only S4 is in the A recirculation path and only S6 is in the B recirculation path and these registers shift left only one bit position. Phase  $\Phi 7$  is reached either after one cycle of  $\Phi 3 \ S8$  or directly from  $\Phi 3 \ \overline{S8}$  if S14 is reset. Sk is set which, in turn, forces phase  $\Phi 7$  and causes the P register to be incremented.



$$sSk = \overline{F1} F3 \overline{T8} 05 \overline{S9} \overline{S10} \overline{S11} \overline{S12} \overline{S13} \overline{S14} T0 \\ + \emptyset 3 T0 S8 + - - -$$

The normalize instruction is only slightly different. Sk is set before the shift count reaches zero to force phase  $\emptyset 7$ , providing the two most significant bits of A are different.

$$sSk = \overline{F1} F3 05 06 \overline{T8} S2 T0 (Aw \overline{An} + \overline{Aw} An) + - - -$$

Here An at T0 time represents the "old" sign bit and Aw at T0 time represents the "new" A1 bit (except during phase  $\emptyset 1$  where the above term is more easily understood). Depending on the situation, the S8 flip-flop must sometimes be forced to complete an odd number of shifts. The Ia flip-flop picks up the new A2 bit by reading Aw at T1.

$$sIa = \overline{F1} F3 \overline{T8} Aw T1 + - - -$$

$$rIa = T24 \emptyset 3 + - - -$$

S8 is then set for a single shift if Ia is different from the "old" sign bit of A.

$$sS8 = \overline{F1} F3 05 06 \overline{T8} S2 T0 (An \overline{Ia} + \overline{An} Ia)$$

(S8 may be forced at the same time that Sk is, but Sk will force  $\emptyset 7$  to terminate the shifting regardless of S8).

During normalize the X register is decremented, two for each  $\overline{S8} \emptyset 3$  cycle and one for each S8  $\emptyset 3$  cycle. Ix is used as a carry in a half adder.

$$sIx = 05 06 \emptyset 3 T23 \overline{S8}$$

$$+ 05 06 \emptyset 3 T24 S8$$

$$+ - - -$$

$$rIx = 05 06 \emptyset 3 \overline{T24} Ix Xn + - - -$$

$$sXw = Xnr \emptyset 3 (\overline{Ix} Xn + Ix \overline{Xn}) + - - -$$

$$Xnr = \emptyset 3 05 06 S2 + - - -$$

## ARITHMETIC INSTRUCTIONS

Instructions 54 (SUB), 55 (ADD), 56 (SUC) and 57 (ADC)

Phasing:  $\emptyset 0 \rightarrow \emptyset 6 \rightarrow \emptyset 0$

During phase  $\emptyset 0$  the operand is accessed in the normal fashion and at Tp the phase counter is advanced to phase  $\emptyset 6$ . During phase  $\emptyset 6$  the contents of the C register are shifted through the adder and are added or subtracted from the contents of the A register.

$$Cs = F1 \overline{F3} \overline{Tp} \overline{T24} + - - -$$

$$sAw = 01 \overline{02} 03 04 \emptyset 6 \text{ Add} + - - -$$

$$\text{Anr} = \overline{02} 03 04 \emptyset 6$$

Instruction 54 (SUB) and 56 (SUC)

$$Xz = An F1 03 + - - -$$

$$Yz = F1 \overline{C23} \overline{06} + - - -$$

$$sCz = \emptyset 6 T24 04 \overline{05} \overline{06} + \emptyset 0 01 \overline{02} 04 05 Tp Xw + - - -$$

The Cz flip-flop is preset to complete the two's complement. It is always preset by code 54. It is preset by code 56 only if X0 has a "one".

Instruction 55 (ADD) and 57 (ADC)

$$Xz = An F1 03 + \dots$$

$$Yz = F1 C23 06 + \dots$$

$$sCz = \overline{00} 01 \overline{02} 04 05 T_p Xw + \overline{F3} \overline{T_p} \overline{T24} \overline{T0} Xz Yz \overline{Cz} \overline{T_s} + \dots$$

$$rCz = \overline{F3} \overline{T24} \overline{Xz} \overline{Yz} Cz \overline{T_s} + T0 \overline{F3} \overline{T_s} \overline{F1} + \dots$$

Instructions 54, 55, 56 and 57

At Tp 06 the phase counter is reset to phase 00. The Overflow flip-flop will be set if the result of the arithmetic operation exceeds the allowable number range.

$$sOf = 01 \overline{02} 03 04 06 T0 (\overline{Xz} \overline{Yz} Cz + Xz Yz \overline{Cz})$$

The state of Of can then be tested with an SKS instruction.

Of is reset at 00 Tp of instructions 56 and 57.

$$rOf = T_p 00 01 \overline{02} 04 05$$

The state of the carry flip-flop at time T14 is picked up by the Ix flip-flop and stored in X1.

$$sIx = 01 \overline{02} 03 04 06 T14 Cz$$

$$sXw = Xnr \overline{02} 03 Ix T1$$

$$Xnr = 01 \overline{02} 03 04 06 \overline{Q1} \overline{Q2} \overline{Q3}$$

The state of the carry flip-flop Cz at Tp is anticipated at T0 and stored in X0.

$$sXw = Xnr \overline{02} 03 T0 [Xz Cz + Yz Cz + Xz Yz]$$

Instruction 63 (ADM)

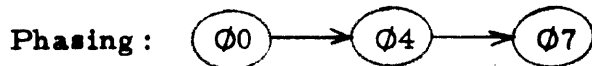

The effective address is computed and sent to the S register during phase 00 as usual. At 00 Tp the operand is brought from the M register to C.

$$Cxm = \overline{P0} (\overline{00} \overline{Ia} \overline{02} \overline{03} 01) 00$$

During phase 04 the adder is fed by An and C23. The output of the adder is fed back to C0.

$$sC0 = 04 01 05 06 Add$$

At 04 Tp the M register is cleared and P0 is set to write in memory.

$$Mc = T_p 04$$

$$sP0 = Mc T_p$$

$$Mxc = P0 T24$$

$$rP0 = P0 T24$$

During 04 the P register is incremented. It is sent in parallel to S at 07 T9 to access the next instruction.

The Overflow flip-flop will be set if the result of the arithmetic operation exceeds the allowable number range.

$$\begin{aligned} sOf &= 01\ 05\ \overline{04}\ 06\ T0\ Xz\ Yz\ \overline{Cz} \\ &+ \overline{03}\ \overline{04}\ T0\ (\overline{05} + 06)\ \overline{Xz}\ \overline{Yz}\ Cz \\ &+ \dots \end{aligned}$$

### Instruction 64 (MUL)

Multiplication requires four cycle times. The phasing is  $\textcircled{00} \rightarrow \textcircled{01} \rightarrow \textcircled{03} \rightarrow \textcircled{07}$  with one cycle time per phase.

During phase  $\textcircled{00}$ , indexing is performed, the instruction is regenerated in memory and the operand is accessed. If the contents of the A register are negative, Rf is set at  $\textcircled{00}\ T_p$ .

$$sRf = \overline{03}\ 04\ \overline{05}\ \overline{06}\ T_p\ \textcircled{00}\ Aw$$

During phase  $\textcircled{01}$ , the operand is regenerated. If the A register was negative, as indicated by Rf, it is two's complemented to make it positive. Cz is used as a carry to complement A. Rf, if set, remains set during the entire operation. The memory is not pulsed during either phase  $\textcircled{01}$  or phase  $\textcircled{03}$  so that the S register is free from memory control from time T10 of phase  $\textcircled{01}$  until T10 of phase  $\textcircled{07}$ . Parity of the operand is checked during phase  $\textcircled{01}$  as the C register shifts around to itself.

At  $\textcircled{03}\ T_{24}$ , the C register is cleared and the multiplication begins. The M register, since the memory was not pulsed during  $\textcircled{01}$ , still contains the operand or multiplicand. The A register, which is now positive, presents its least significant bit at time T23 to the input gates of many serial adders. The Ap buffer amplifies An.

$$Ap = An\ \overline{F1}$$

The multiplication amplifier comes on during phase  $\textcircled{03}$  and  $\textcircled{07}$ , excluding the check bit times :

$$Mt = \overline{03}\ 04\ \overline{05}\ \overline{06}\ F2\ \overline{T_p}\ \overline{T_{24}}\ \overline{T_s}$$

Mu controls the S register for performing the carrying. Mu is on during phase  $\textcircled{03}$  and the first half of phase  $\textcircled{07}$ .

$$Mu = \overline{03}\ 04\ \overline{05}\ \overline{06}\ F2\ \overline{T_p}\ \overline{T_{24}}\ \overline{T_s}\ (\overline{F1} + Q2)$$

Now twenty-three serial adders are fed simultaneously into C1 through C23, respectively. The inputs to the adders are controlled on one side by the preceding stage of the C register and on the other side by an AND gate of Ap and the corresponding bit of the M register. (See diagram)

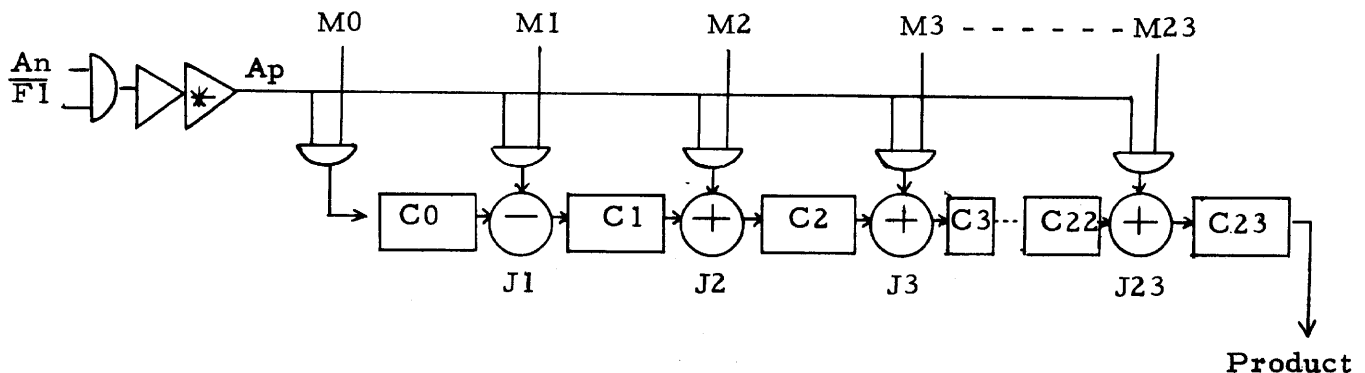

There is no adder necessary for C0 and the logic of the adder J1 is modified to actually subtract. This is because bits coming from C0 are negative in weight rather than positive. Each adder requires a carry flip-flop. Since the S register is free, the flip-flops S1 through S14 serve as carry flip-flops for adders J1 through J14, respectively. Other flip-flops, which are otherwise idle during multiplication, are made to perform as carry flip-flops for the rest of the adders.

The least significant bit of the product is sent to C23 at  $\Phi 3$  T23. Bits flowing from C23 are then sent to Aw. An is sent to Bw which is meaningful only during phase  $\Phi 7$ . As C23 is sent to Aw, the product is negated, again using Cz as a carry, if Rf is set.

$$\begin{aligned} sAw &= Mt \overline{Cz} C23 + Mt Cz \overline{C23} \\ sCz &= \Phi 1 Rf An \overline{T24} + Mt Rf C23 \\ rCz &= \Phi 3 T24 \end{aligned}$$

At the end of phase  $\Phi 3$ , the least significant half of the product is in the A register and the most significant half of the product is in the C register and in the various carry flip-flops according to their respective weights.

During  $\Phi 7$ , Ap is cut off and the M register no longer controls the adders. The adders continue to add, however, allowing the carry flip-flops to properly trickle into the product. C23 continues to feed Aw and An continues to feed Bw.

The P register is incremented in the usual fashion during the first half of phase  $\Phi 7$ . At  $\Phi 7$  T10 the S register must be cleared so that it can be set by the P register, in parallel, to access the memory for the next instruction. However, by  $\Phi 7$  T10 the carrying process has just passed the fourteen bits of the S register; they are free at exactly the right time. The rest of the adders must continue their process until the completion of the instruction.

At the end of phase  $\Phi 7$ , the most significant half of the product is in A, the least significant half is in B, the next instruction has been accessed. (The M register was not needed for multiplication during  $\Phi 7$ ).

If a time share (Ts) interrupts the instruction at the end of phase  $\Phi 0$  or  $\Phi 1$ , there is a problem. The operand in C is exchanged with W and then exchanged back again. The M register is modified by the input or output word from the buffer. In this case, the operand in C is transferred back to the M register before the multiplication begins.

$$\begin{aligned} Mxc &= P0 T24 \\ sP0 &= Mc Tp \\ Mc &= Tp Ts \overline{Tsm} F3 \overline{06} \end{aligned}$$

If a time share (Ts) interrupts at the end of phase  $\Phi 3$ , the word in M is destroyed but it is no longer needed for the multiplication. The partial product in C is sent to W and then back to C.

If -1 is multiplied by -1 the overflow flip-flop is set.

$$sOf = Mt T0 F1 Rf C23 \overline{Cz}$$

Here Mt T0 F1 specifies phase  $\Phi 7$  of multiply at time T0. Rf indicates A was originally negative.  $\overline{Cz}$  indicates that no "ones" have yet appeared in the product and C23 indicates that M0 was set.

920 MULTIPLY EXAMPLE

1.10100 (- 3/8) x 1.10010 (- 7/16) = 0.0010101 (+ 21/128)				
sRf = $\overline{03}$ $\overline{04}$ $\overline{05}$ $\overline{06}$ Tp Ø0 Aw + - - -				
Phase	Ø3		A	B
T23	S MA <sub>P</sub> C J	00000 000000 <u>000000</u> 00000	0.01110	XXXXXX
T22	S MA <sub>P</sub> C J	00000 110100 <u>000000</u> 10100	000111	0XXXXX
T21	S MA <sub>P</sub> C J	00000 110100 <u>110100</u> 01110	000011	10XXXX
T20	S MA <sub>P</sub> C J	00000 110100 <u>101110</u> 00011	000001	110XXX
T19	S MA <sub>P</sub> C J	00100 000000 <u>100011</u> 10101	sCz = Mt Rf C23 + - - - 000000	1110XX
T18	S MA <sub>P</sub> C J	10000 000000 <u>010101</u> 11010	100000	01110X

Phase Ø7			A	B
T23	S MAp C J	10000 000000 <u>011010</u> 11101	010000	001110
T22	S MAp C J	10000 000000 <u>011101</u> 11110	101000	000111
T21	S MAp C J	10000 000000 <u>011110</u> 11111	010100	000011
T20	S MAp C J	10000 000000 <u>011111</u> 11111	101010	000001
T19	S MAp C J	10000 000000 <u>011111</u> 11111	010101	000000
T18	S MAp C J	10000 000000 <u>011111</u> 11111	001010	100000
			0.00101	010000

Instruction 65 (Div)

Phasing is  $\textcircled{\text{00}} \rightarrow \textcircled{\text{01}} \rightarrow \textcircled{\text{03 } \overline{\text{S8}}} \rightarrow \textcircled{\text{03 } \text{S8}} \rightarrow \textcircled{\text{07}}$  with one cycle time per phase except for  $\text{03 } \overline{\text{S8}}$  which lasts 24 cycle times.

During  $\text{00}$ , the instruction is regenerated in memory, indexing is performed and the operand or divisor is accessed.

During  $\text{01}$ , the operand is parity checked and regenerated in memory. The memory is not pulsed during phases  $\text{01}$  or  $\text{03}$  which releases the S register to aid in the division. At  $\text{01 } T_p$  the  $S1$  flip-flop is set if the sign of A and the sign of the divisor in C are alike.  $S1$  will remain set until the "clean up" phase  $\text{03 } \text{S8}$ .

Division takes place during  $\text{03 } \overline{\text{S8}}$ . The A and B registers shift left without arithmetic the first cycle time. Each cycle time thereafter, the A register is shifted left and simultaneous subtraction (or addition if  $\overline{\text{S1}}$ ) may or may not occur according to the result of a previous "pseudo" subtraction. The algorithm is such that if the divisor can be subtracted (added, if  $\overline{\text{S1}}$ ) without changing the sign of A, it will be subtracted. If it would change the sign of A, it will not be subtracted. The sign of A, therefore, never changes during a "normal" division.

The  $S4$  flip-flop is inserted between  $A_n$  and  $A_w$  to cause A to shift left.  $S6$  is simultaneously used in a similar manner to shift B left. As the shifting takes place, a "pseudo" subtraction is performed using  $S2$  as a carry flip-flop. The final state of  $S2$  at each cycle indicates whether a real subtraction can be performed the following cycle time without changing the sign of A.

$$\begin{aligned} sS2 &= \text{03 } \overline{\text{05}} \text{06 } \overline{\text{T24}} \overline{\text{Tp}} \overline{\text{S8}} \text{C23} (\text{S4 } \overline{\text{S1}} + \overline{\text{S4}} \text{S1}) \\ &\quad + \text{03 } \overline{\text{05}} \text{06 } T_p \overline{\text{C0}} \overline{\text{S2}} \\ rS2 &= \text{03 } \overline{\text{05}} \text{06 } \overline{\text{T24}} \overline{\text{Tp}} \overline{\text{S8}} \text{C23} (\text{S4 } \text{S1} + \overline{\text{S4}} \overline{\text{S1}}) \\ &\quad + \text{03 } \overline{\text{05}} \text{06 } T_p \overline{\text{C0}} \text{S2} \\ &\quad + \text{03 } \overline{\text{05}} \text{06 } \text{T24} \end{aligned}$$

Note that  $S2$  is reset at the beginning of each cycle at  $T24$ , then if  $S1$  is set indicating like signs of A and C,  $S2$  performs a borrowing function on  $C23$  and  $S4$ .  $S4$  contains the same bits that  $A_n$  will contain on the next cycle. At  $T_p$  the  $S2$  flip-flop is reversed if C is positive so that at the following  $T24$  time,  $S2$  will be set if, and only if, arithmetic is to be performed during the following cycle time.  $S3$  is set by  $S2$  at  $T24$  and allows arithmetic while  $S2$  performs another "pseudo" subtraction.  $S3$  is reset each  $T_p$  time and is set at  $T24$  only if  $S2$  is high at  $T24$ .

$S4$  actually receives the output of the adder. The inputs of the adder are  $A_n$  on one side and the product of  $S3$   $C23$  on the other. If  $S1$  is set, the adder actually subtracts since  $C_z$  will borrow rather than carry. If  $S1$  is reset, the adder adds.

Because of the algorithm, the sign of A will not change unless the original magnitude of A was larger than that of C. In this case, the algorithm cannot prevent a sign change. The overflow flip-flop is set on the sign change.

$$s0f = \emptyset 3 \overline{05} 06 \overline{S8} T_p (A_n \overline{S4} + \overline{A_n} S4)$$

In this term,  $A_n$  contains the old sign and  $S4$  contains the new computed sign. The A register was shifted left one bit position during the first  $\emptyset 3$  cycle.

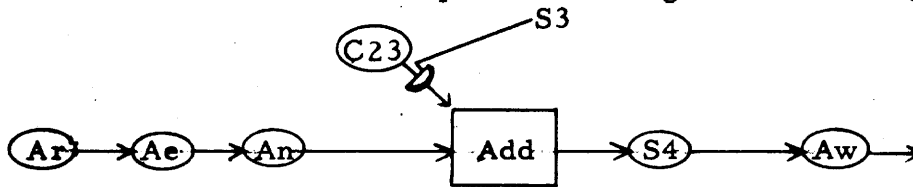

$$Xz = A_n F3 06$$

$$Yz = F3 S3 C23$$

The most significant bits of B are picked up by  $S4$  at each  $T_p$  time, and held there two clock times so that the word in A can be read at  $S4$  from  $T23$  to  $T_p$  time (25bits).

The quotient bits are shifted into the least significant bit of the B register, by pre-setting  $S6$  correctly at  $T24$ .

$$sS6 = \emptyset 3 \overline{05} 06 T24 (S1 S2 + \overline{S1} \overline{S2})$$

$$rS6 = \emptyset 3 \overline{05} 06 T_p$$

$S5$  determines each cycle time if the magnitude of C equals the magnitude of A. It does this with the aid of  $S7$ . The purpose of determining magnitude equality is for the clean up phase,  $\emptyset 3 S8$ .  $S7$  is reset at each  $T_p$ . If  $S1$  is reset indicating that the signs are unlike, then  $S7$  is set with the first "one" from  $C23$ . The function  $[S7 C23 + S7 \overline{C23}]$  presents C in such a manner that it can be compared bit by bit with the word in A to determine magnitude equality.  $S5$  is reset at each  $T24$  and is set if the output of the adder does not compare with this function in any bit position. If  $S5$  remains reset until  $T_p$ , the magnitudes are equal which is important during the clean-up cycle.

At the completion of 24 cycle times, the  $S8$  flip-flop is set at  $T_p$ . The 24 cycles are counted by  $S9$  through  $S13$  at each  $\emptyset 3 T23$  time. During the one cycle of  $\emptyset 3 S8$  the A register is shifted right and placed into the B register. The quotient in B is sent to A. In addition, the following table indicates other functions to be performed:

$$S5 S1 = \text{nothing}$$

$$S5 \overline{S1} = \text{Add one to quotient}$$

$$\overline{S5} S1 = \text{clear remainder and add one to quotient}$$

$$\overline{S5} \overline{S1} = \text{clear remainder}$$

At  $\emptyset 3 S8 T24$ , the  $S1$  flip-flop is reversed if  $S5$  is set. Then  $S1$  is used, regardless of  $S5$ , as a carry to add one to the quotient in B as it is transferred to A.

$$sAw = \emptyset 3 \overline{05} 06 S8 (B_n \overline{S1} + \overline{B_n} S1) + \dots$$

$$sS1 = \emptyset 3 \overline{05} 06 S8 S5 \overline{S1} + \dots$$

$$rS1 = \emptyset 3 \overline{05} 06 S8 S5 S1 + \emptyset 3 \overline{05} 06 S1 \overline{B_n} S8 \overline{T24} + \dots$$

The remainder in A is transferred to B and shifted right. It is cleared to zero if  $S5$  is reset.

$$sBw = \emptyset 3 \overline{05} 06 S8 S5 Ae$$



The overflow flip-flop can also be set if the one, which may be added to the quotient, changes the sign of the quotient from positive to negative. This takes care of the cases:

$$Q = \frac{+N}{\pm N} = +1 \text{ or } Q = \frac{-N}{-N} = +1 = \text{overflow}$$

$$sOf = \Phi 3 \overline{05} 06 \overline{S8} \overline{Bn} S1 T0$$

There is also the case:

$$Q = \frac{+N + \delta}{\pm N}$$

where  $\delta$  is a small quantity initially in the B register. In this case S5 remains reset until the first non-zero bit is shifted into A. At this time, the overflow flip-flop is set:

$$sOf = \Phi 3 \overline{05} 06 \overline{S8} T_p \overline{An} \overline{S5} Ar$$

In this term, Ar contains the one bit from the B register after it has been sent through the A register delay circuits the first time.

Finally, there is the analogous case:

$$Q = \frac{-(N + \delta)}{\pm (N - 1)}$$

where  $\delta$  is enough to stop the sign from changing but allows the remainder to become larger than the denominator. The first cycle of  $\Phi 3 \overline{S8}$ , D5 is low and thereafter it is high.

$$sD5 = \Phi 3 \overline{05} 06 T_p + - - -$$

During the first cycle S5 makes a slightly different comparison if the numerator is negative. This is because S7 is preset during phase  $\Phi 1$ .

$$sS7 = \Phi 1 \overline{05} 06 T_p Aw$$

and is reset by the first "one" in C23 if the signs are alike.

$$rS7 = \Phi 3 \overline{05} 06 \overline{S8} T_p T_{24} C23 S1$$

The overflow flip-flop is set if S5 is still reset at the end of the first cycle and the numerator is negative (S4).

$$sOf = \Phi 3 \overline{05} 06 T_p S4 S5 \overline{D5}$$

It can be seen that if the overflow is set, particularly if it is set due to a sign change of A, the results of the division are almost meaningless and cannot be salvaged by programming except by shifting and dividing again.

At  $\Phi 3 S8 T0$ , the Sk flip-flop is set. This forces phase  $\Phi 7$  and also causes the P register to be incremented. The memory is then pulsed to access the next instruction.

### 920 DIVIDE EXAMPLE

(using 6-bit instead of 24-bit registers)

$$\frac{0.0100}{0.01011} = 0.11010 + \frac{0.000000010}{0.01011}$$

S3 T23	A Register	B Register	S2 Tp
	During $\phi 3 \overline{S8}$ , S1 is high		
0	010010	000000	0
1	<u>001011</u>		
	000111		
	001110	000001	0
1	<u>001011</u>		
	000011		
	000110	000011	1
0	001100	000110	0
1	<u>001011</u>		
	000001		
	000010	001101	1
0	000100	011010	1
At $\phi 3 \overline{S8} T24$ , S1 and S5 are high At $\phi 3 \overline{S8} T23$ , $\overline{S1}$ and S5 are high			
	Quotient	Remainder	
	0.11010	0.00010	

## MEMORY PARITY

### MEMORY PARITY GENERATION

The memory has a capacity for 25-bit words. One of these bits is used for parity. The total number of ones in any word in memory, including the parity bit, must be even. If a word read out of memory has an odd number of ones, then normally the computer will halt and the memory parity indicator on the control panel will be lit. Parity is automatically generated on words stored in the memory.

The C24 flip-flop generates parity on words entering the C register serially. It counts ones in the C0 flip-flop as the entering bits step through; it counts from T22 to Tp.

$$sC24 = (\overline{T24} \overline{T23}) C0 \overline{C24}$$

$$rC24 = (\overline{T24} \overline{T23}) C0 C24 + T23 + \textcircled{St}$$

The C24 flip-flop is transferred to M24 with the rest of the C register when Mxc is actuated. This is at T24 time. Even on the parallel input (PIN) instruction, C24 generates parity by shifting the contents of C serially in phase  $\phi_4$ .

### MEMORY PARITY CHECKING

The Cp flip-flop checks parity on words read from memory. It counts ones as they step out of the C register at C23. It is preset by the parity bit from memory. If, after it has counted all the ones, it is left set, it will cause Ht to be set and the computer will halt.

When the Control switch is in the Idle position and Go and Ht are both reset, which is normal, Cp is reset every T24 time. It may be set at Tp for one pulse time, if the parity bit in memory M24 is set, but Cp will be reset again at T24.

When the Control switch is moved and Go is set, Cp will properly preset at the same time Go is set.

$$sCp = M24 Tp \overline{Ht} \overline{Ts} + - - -$$

$$rCp = \overline{Go} \overline{Ht} T24 + - - -$$

During any phase that parity is not being checked it will be turned off at T0 time.

$$rCp = (\overline{F1} \overline{F2} \overline{Ts} \overline{Wp} + 01 \phi_4 + 03 \phi_6) \overline{Ts} \overline{Ht} T0$$

Cp is preset by the memory parity bit and then is complemented by every "one" stepping out of the C register at C23 during certain phases.

$$sCp = \overline{Cp} C23 \overline{Ht} (T23 - T0) (\overline{F1} \overline{F2} \overline{Ts} \overline{Wp} + 01 \emptyset4 + 03 \emptyset6)$$

$$rCp = Cp C23 \overline{Ht} (T23 - T0) (\overline{F1} \overline{F2} \overline{Ts} \overline{Wp} + 01 \emptyset4 + 03 \emptyset6)$$

The above term gives the phases when parity is checked. If at Tp the Cp flip-flop is set, an odd number of ones must have come from memory. If so, an error is indicated and Ht is set to halt the computer,

$$sHt = Cp Tp \overline{Ts} (\textcircled{Kp}) + - - -$$

where  $\textcircled{Kp}$  is from the Parity switch on the control panel and is true in the halt position. When both Cp and Ht are set, they lock each other set. The gate Cp Ht controls the parity error light on the control panel.

When Cp and Ht are set, the Control switch is inoperative because Ht will not reset. The computer idles because Go will reset at the completion of the instruction. The computer is inoperative until the Parity switch is placed in the continue position and the Control switch is returned to Idle.

$$rCp = (\textcircled{Kp}) Ht + - - -$$

$$rHt = (\textcircled{Ks}) (\textcircled{Kg}) \overline{Go} \overline{Cp} T24 + - - -$$

The Cp flip-flop will not trigger when Ht is set until the parity switch is placed in Continue.

Parity is not checked on certain instructions from the memory.

These are the instructions that use phase  $\emptyset5$  (00, 02, 20, 40, 46). Other operation codes that are not used also cause  $\emptyset5$  and they are not parity-checked (04, 06, 22, 24, 26, 42, 44). The reason is that the C register cannot shift during phase  $\emptyset5$ .

Words from the memory delivered to the W or Y Buffer during a time-share interlace are not parity-checked.  $\overline{Ts}$  inhibits the check.

When the computer is locked up with a parity error (Cp Ht), an interrupt request will not re-start the computer.

$$rHt = (\textcircled{Kg}) \text{Int} \overline{Cp} + - - -$$

The first instruction executed when starting or stepping will not be checked because this instruction may have been manually generated by the operator, using the control panel. This is accomplished by inhibiting Cp when Wp is on.

$$sCp = - - - (\emptyset0 \overline{Wp} \overline{Ts} + - - -) \overline{Cp} C23$$

$$rCp = - - - (\emptyset0 \overline{Wp} \overline{Ts} + - - -) Cp C23$$

Wp will always be turned on during the idle phase,

$$sWp = (\overline{Go} + Tsw) \overline{Tsy} \overline{Tsm} Tp$$

and it will be turned off at Tp time at the end of the first phase  $\emptyset0$ .

$$rWp = (Go \overline{Tsw} + (\textcircled{Tsy})) \overline{Tsm} Tp + - - -$$

## IMPLEMENTATION

The algebraic equations discussed in preceding sections are implemented in the computer using diode-transistor logic (DTL).

The diode-transistor circuits are all silicon and are divided into several module types. Each of these modules uses printed circuit techniques on glass epoxy boards. The output signal levels for the circuits are:

one = true output = + 9.5v to + 6.5v

zero = false output = + 0.6v to 0.0v

The supply voltages to all circuits are +25, +8, 0v, and -25 v. The following descriptions are of individual circuit types and do not represent the contents of any actual module.

### GATES

#### AND Gates

The algebraic expression  $ABC$  represents an "AND" expression and is implemented by the use of an AND gate composed of diodes and resistors.

The function of an AND gate is that it will yield a high output (true) only if all of its inputs are true.

Logic Diagram:

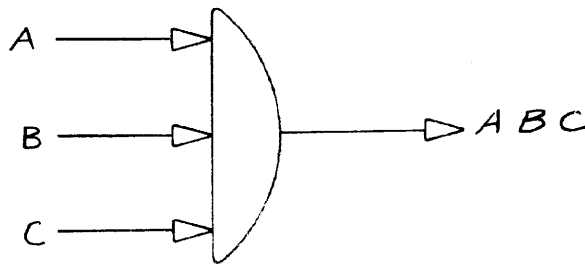

**Schematic Diagram:**

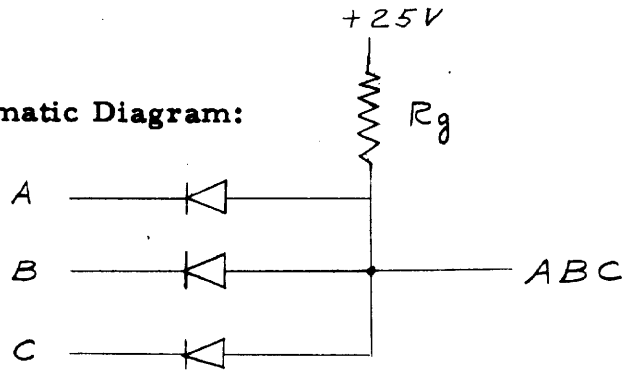

The AND gate operates as follows: If any one of the inputs is false (0 volts), it must absorb the full load of  $R_g$  and the output point (ABC) will fall to 0 volts (except for the forward drop at the diode); when all three inputs are true (approximately +8v), the output point will be at the potential of the most negative of the inputs.

**OR Gates**

The algebraic expression  $A + B + C$  represents an OR expression and is implemented through the use of an OR gate composed of diodes and resistors. The OR gate shown below generated the logical OR function of several input signals. The input signals may be provided by inverters, buffers, or flip-flops.

**Logic Diagram:**

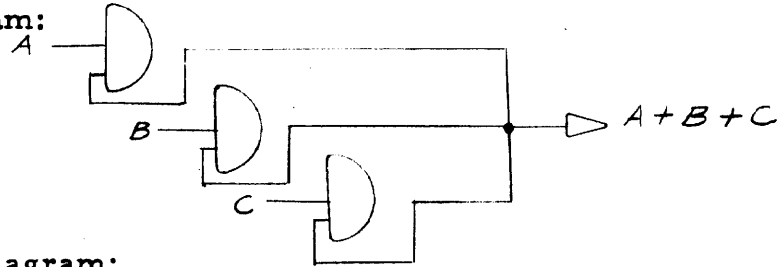

**Schematic Diagram:**

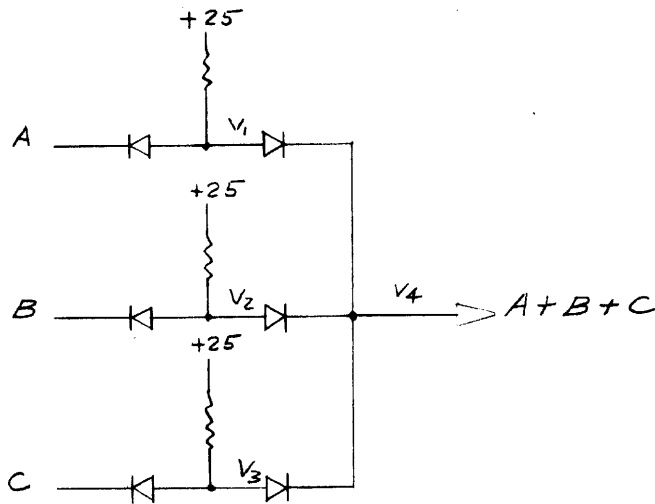

If any one of the input terms is true (+8v), its output-point, V1, V2, or V3, will be at + 8 and will hold the output V4 true, and the other two OR diodes will be back-biased unless a similar condition exists.

### AND-OR Gate

AND-OR expressions such as  $AB + C$  can be implemented in the following manner:

Logic Diagram:

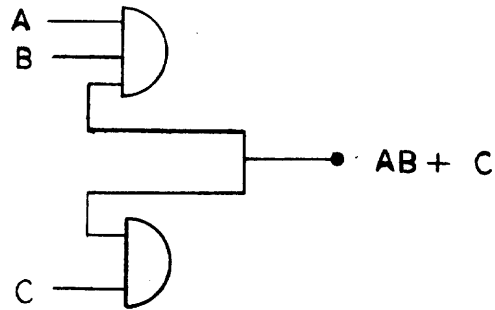

Schematic Diagram:

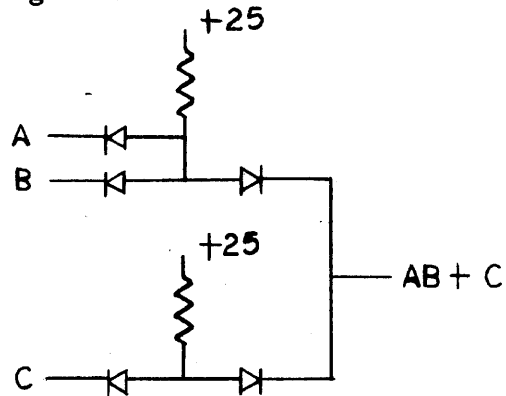

This circuit operates essentially the same as the previously described OR gate with additional diodes on the input to form AND gates. Or it can be said that all OR gates must be fed from AND gates, though they may have a single term, as in the previous case.

An OR gate can be formed by connecting one input terminal of each of several AND gates. The resulting OR output must be connected to the input terminal of an Inverter, Buffer, or a flip-flop.

## AND-OR-AND Gate

An algebraic AND-OR-AND expression, such as  $(AB + C) DE$ , can be implemented in the following manner:

Logic Diagram:

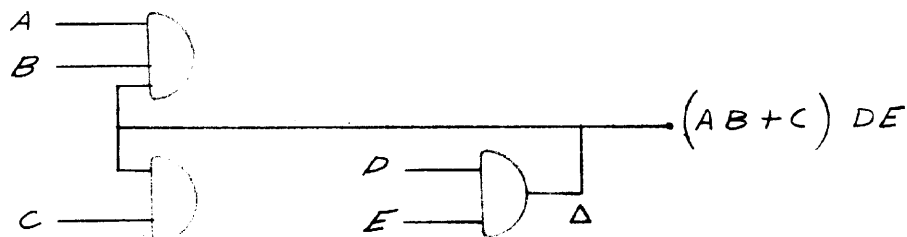

Schematic Diagram:

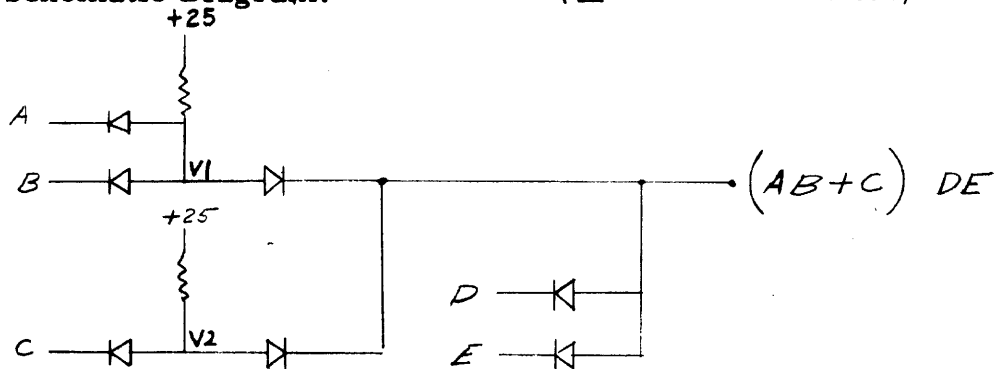

Note that if D or E goes false they will absorb the current load of both  $R_g$  resistors and the output will be false as well as points V1 and V2.

## INVERTERS, BUFFER AMPLIFIERS, AND FLIP-FLOPS

### Inverters

An inverter circuit generates the inverse of the output of any gate. The input circuit has a Zener diode to provide a stable input threshold of approximately +3 volts. This reduces noise problems as it essentially provides noise rejection. This Zener also clamps input signals to approximately +3 to +6 volts through the base emitter junction of the transistor.



Logic Diagram:

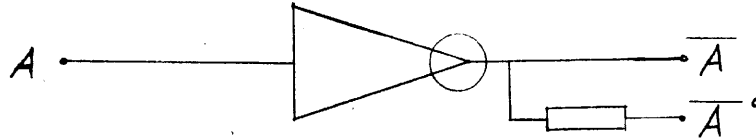

Schematic Diagram:

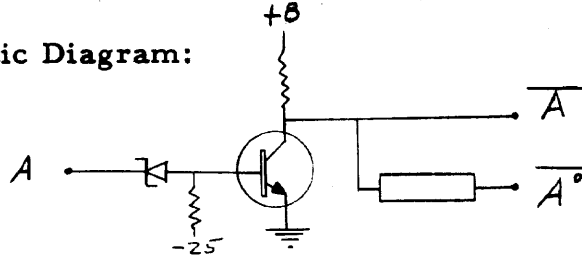

To invert a single input signal an AND gate or an AND-OR gate coupling circuit is used with an inverter and must be fed from isolated circuits.. The  $\bar{A}$  output uses a high loss magnetic element to reduce ringing on long connecting lines.

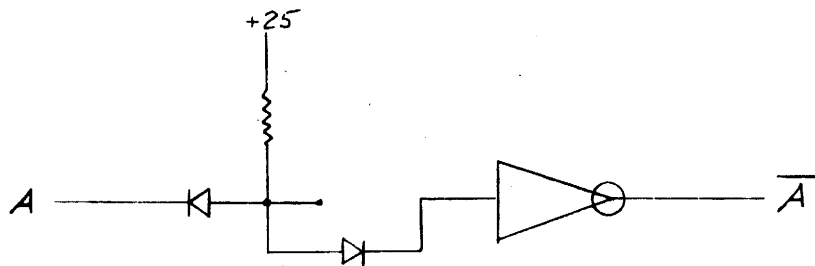
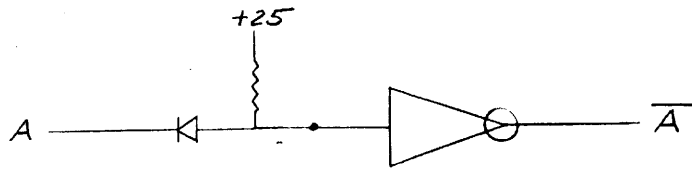

Buffer Amplifiers

A buffer amplifier generates a buffered signal from the output of any gate. The input circuit has a Zener diode to provide a stable input threshold of approximately + 3 volts. The rules for coupling to the input are the same as those for the inverter.

Logic Diagram:

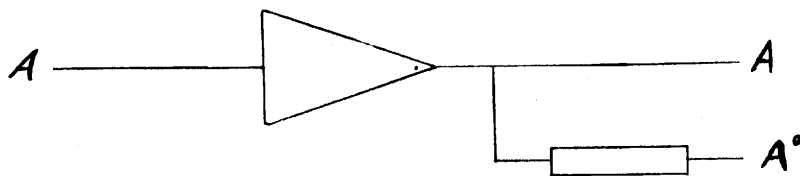

**Schematic Diagram:**

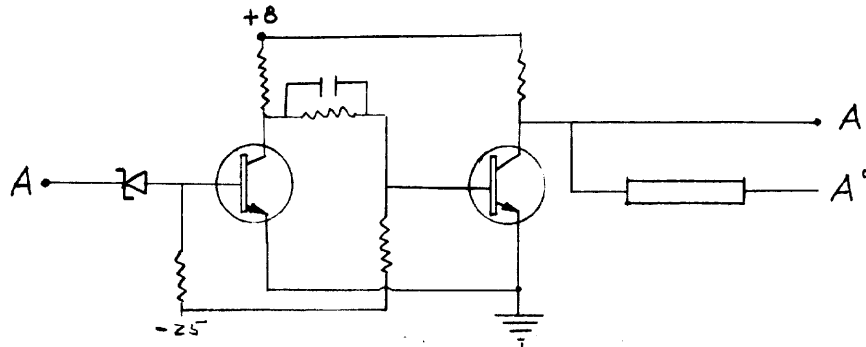

**Flip-Flops**

Two basic types of flip-flops are used. The first is a standard, set-reset flip-flop shown below. All flip-flops are clocked on input and clock is always transformer-coupled. The clock signal is approximately 100 nanoseconds wide (positive signal) and the flip-flop will trigger on the trailing edge.

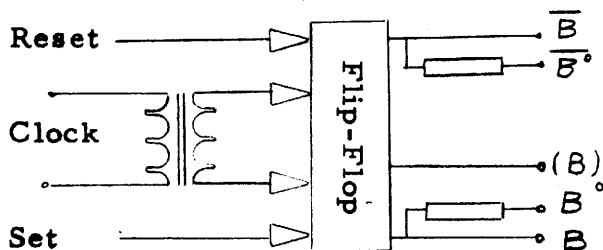

The  $B^\circ$  and  $\bar{B}^\circ$  outputs use special high loss magnetic elements to reduce line ringing and are used for outputs where the wire length is considerable.

The (B) output is used for additional source power and can be coupled directly to B or to a separate load resistor and used independently.

The second type of flip-flop is the repeater. This flip-flop cannot set or reset if the "hold" input is false. If the hold input is true the flip-flop will reset if there is no true input present on the set side. This flip-flop has similar outputs to the Rs-type but also has a DC set input and a special input from the dynamic register card.

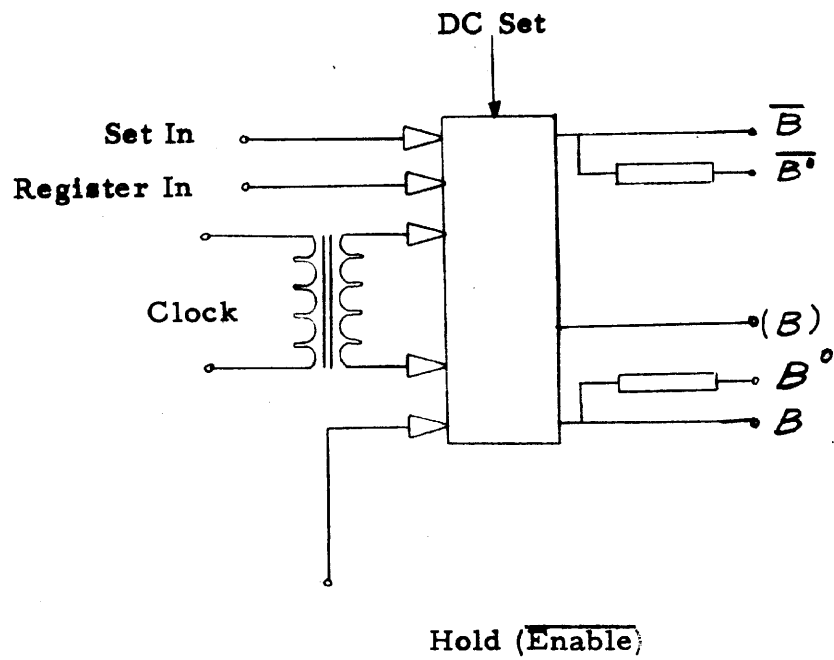

REPEATER FLIP-FLOP

## DICTIONARY OF COMPUTER LOGIC TERMS

Add	The output of the full adder gate whose inputs are Xz (augend) and Yz (addend)
Ae	The "A early" flip-flop for the A register. It is part of the A register recirculation loop. It is fed by Ar and, in turn, normally feeds An.
An	The "A now" flip-flop for the A register. It is part of the A register recirculation loop. It is fed by Ae and, in turn, normally feeds Aw. It presents the bits in A in time with the timing counter.
Anr	The gate blocking recirculation of the A register (A not recirculate).
Ap	An amplifier used in multiplication that amplifies An.
Ar	The "read" flip-flop for the A register (feeds An). It is part of the A register recirculation loop.
Aw	The "write" flip-flop for the A register (feeds A) and is fed by An.
Be	The "B early" flip-flop for the B register. It is part of the B register recirculation loop. It is fed by Br and, in turn, normally feeds Bn.
Bn	The "B now" flip-flop for the B register. It is part of the B register recirculation loop. It is fed by Be and, in turn, normally feeds Bw. It presents the bits in B in time with the timing counter.
Bnr	The gate blocking recirculation of the B register (B not recirculate).
Br	The "read" flip-flop for the B register (feeds Bn). It is part of the B register recirculation loop.
Buc	A control term sent to the W Buffer, derived from the EOM instruction.
Bw	The "write" flip-flop for the B register (feeds B) and is fed by Bn.
C0-C23	The 24 repeater flip-flops of the C register.
Cd0-Cd23	The C register input data lines.
C24	The flip-flop which sets the parity of the C register when C shifts.
Cg	The gate which "enables" the C register.
Cp	The flip-flop which checks parity as the C register is shifted.
Cs	The gate which shifts the C register right.

Cxi	The transfer term for the external signals on a PIN instruction.
Cxm	The transfer term for transferring the contents of the M register to the C register.
Cz	The "Carry" flip-flop for the full adder.
D1-D6	Flip-flops used in multiplication and for register exchange.
En	The flip-flop which "enables" the interrupt system. This flip-flop is under program control.
En	The manual "enable" switch. This switch overrides $\overline{En}$ .
Eom	The output or execute term for the EOM (02) instruction.
End	The gate which represents the last cycle or last two cycles of the instruction being executed.
Ex	The "exchange" flip-flop. It controls the transfer of contents between registers during the exchange operation.
F1, F2, F3	The three flip-flops which constitute the phase counter.
Go	The control flip-flop which allows computation or operation.
H	The external Halt signal.
Ht	The control flip-flop which forces the computer to halt.
Ia	The "indirect address" flip-flop. This flip-flop is also used in incrementing the P register.
Ib	The term which signals to the interrupt logic that the interrupt subroutine is complete.
Ie	The term signaling that the interrupt subroutine is entered.
Ij	The signal indicating that a "single-instruction" interrupt channel has requested an interrupt.
Int	The "Interrupt" flip-flop. This flip-flop inhibits the reading of the next instruction and forces a transfer.
Ioc	The input control signal derived from Eom.
Ipl, Ip2, - - -	A flip-flop which indicates in its set condition that the computer has entered the interrupt program.
Ir	The "request" for interrupt signal from the interrupt logic to the computer.

Is The "request" for interrupt signal from the power fail-safe logic to the computer.

Is1, Is2- - - A flip-flop which indicates in its set state that there is a request for interrupt present.

Ix The Index flip-flop. This flip-flop controls indexing and is time-shared in several other operations.

J1-J23 23 serial adder outputs used in multiplication.

(Ka) A signal from the register display switch to display the A register.

(Kb) A signal from the register display switch to display the B register.

(Kb1) - (Kb4) The signals from the "breakpoint" switches.

(Kc) A signal from the register display switch to display the C register, (or all registers home).

(Kc0) - (Kc23) The individual switches for manually setting the C register from the front panel.

(Kcr) The manual switch for clearing the C register.

(Kf) The "fill" switch for starting the computer.

(Kg) A signal from the control switch that it is in the "run" position.

(Kp) A switch on the control panel which allows a memory parity error to halt the computer.

(Kr) The switch which "holds" the P register at its present count.

(Ks) A signal from the control switch that it is in the "step" position.

L1-L14 The address lines to memory from the S (address) register.

M0-M24 The 25 flip-flops of the M (memory) register.

Ma0-Map The inputs to the discriminators from the sense amplifiers in memory.

Mc The gate which clears the memory register, M, and pulses memory to start its read-write cycle.

Md0-Md24 The inputs to the M register from the discriminators in memory.

Mdt The memory digit timing signal (enables inhibit current).

Me	The "memory enable" signal from the start-up, shut-down relays. Me is normally high.
Mg	The flip-flop which gates all memory operations.
Mh	A signal which disables certain gates during multiply (multiply hold).
Mrt	The read timing gate for memory.
Ms	The memory strobe, the gate which transfers the contents of memory into the M register. It is true at T2 of the memory cycle.
Ms0-Msp	The inputs to the sense amplifiers from the sense windings in memory.
Mt	An amplifier that is true during the execution of multiplication.
Mu	An amplifier that is true during part of the execution of multiplication.
Mwt	The "write timing" gate for memory.
Mxc	The transfer term for transferring the contents of the C register into the M (memory) register for eventual storage.
N9-N14	The address lines decoded from Nc1---which specify the address of the interrupt subroutine.
Nc1---	The address terms from the interrupt logic specifying the address of the interrupt subroutine.
Ø0-Ø7	The decoded signals from the phase counter representing the eight phases of operation.
01-06	The six flip-flops constituting the instruction register.
Oc	The gate which clears the O (instruction) register.
Of	The "overflow" flip-flop.
Oxc	The transfer gate for transferring the instruction code from the C register to the O register.
P1-P14	The 14 repeater flip-flops constituting the P register (program counter).
Pg	The term which "enables" the P register.
Pin	This term is equal to Cxi Q1.
P0	The "program operator" flip-flop. This flip-flop is also time-shared on other operations.

Pot 1	The transfer gate for the POT instruction (T24-Tp).
Pot 2	The transfer gate for the POT instruction (T16-T2).
Q1-Q6	The six flip-flops which make up the pulse counter.
Rf	The "ready" flip-flop which indicates that the external device is ready to receive or ready to transmit data.
Rt	The external ready signal used to set the Ready flip-flop (Rf).
Rti	The ready pulse for computer to computer operation, or can be used to reset the external device on a PIN instruction.
Rw	A "current" direction term for the memory during read.
S1-S14	The 14 flip-flops which make up the S or address register.
Sc	The gate which clears the S (Address) register.
Sio	An externally fed inverter for additional skip inputs (system input/output).
Sk	The "skip" flip-flop which designates the next instruction from $L + 2$ instead of $L + 1$ , where $L$ is the present location.
Sks	The gate representing all inputs for the skip if $\overline{M}$ instruction, where $M$ (the address) designates the particular input.
Ss	"S register step" decrements the S register by two during shift and divide instructions.
Ssc	An externally fed inverter for additional skip inputs (systems communication).
St	The external "start" switch.
Sxc	The transfer gate for transferring the contents of C to S.
Sxn	The transfer gate for transferring the interrupt address to S.
Sxp	The transfer gate for transferring the contents of P to S.
Sys	A control signal for systems communication derived from EOM.
T0-T23	The 24-bit pulse times making up the programmable section of the computer word.
T24, Tp	The two buffer pulse times in the computer word.
Ts	The "time-share" flip-flop; when $T_s$ is true other operations idle.
Tsm	The "memory time-share" flip-flop derived from $T_s$ which transfers control of memory to the interlace register.



Wn            The "now" or "read" flip-flop for the W Buffer. It is the output.

Wp            The flip-flop which designates W as the buffer which is to participate in the time-share operation.

Wr            A "current" direction term for the memory during write.

Xn            The "now" or "read" flip-flop for the X register.

Xnr           The gate which blocks recirculation of the X register (X not recirculate).

Xw            The "write" flip-flop for the X register.

Xz            The augend input to the full adder.

Yz            The addend input to the full adder.

## CONDENSED COMPUTER LOGIC EQUATIONS

### A REGISTER

$$sAe = Ar \overline{\{(\overline{\phi 3} \ 05 \ \overline{06}) (Q1 + Q2 + S8 \ \overline{Q3})\}} + Ar S8$$

$$rAe = \overline{Ar} \overline{\{(\overline{\phi 3} \ 05 \ \overline{06}) (Q1 + Q2 + S8 \ \overline{Q3})\}} + \overline{Ar} S8$$

$$sAn = Ae \overline{\{(\overline{\phi 3} \ 05 \ \overline{06}) (Q1 + Q2 + S8 \ \overline{Q3})\}}$$

$$rAn = \overline{Ae} \overline{\{(\overline{\phi 3} \ 05 \ \overline{06}) (Q1 + Q2 + S8 \ \overline{Q3})\}}$$

Anr =

$$\begin{aligned} & (14-17, 54-57) \quad + \overline{02} \ 03 \ 04 \ \phi 6 \\ & (64, 65, 66, 67) \quad + \phi 3 \\ & (76) \quad + 01 \ 02 \ 03 \ 04 \ 05 \ \overline{06} \ \phi 6 \\ & (62) \quad + \phi 4 \ 01 \ 05 \ \overline{06} \\ & (46) \quad + \overline{02} \ \overline{03} \ 04 \ \overline{T_s} \ C23 \\ & (46) \quad + \overline{02} \ \overline{03} \ 04 \ \overline{T_s} \ C20 \\ & (46) \quad + \overline{02} \ \overline{03} \ 04 \ \overline{T_s} \ C16 \\ & \quad + Ex \ (Ka) \\ & \quad + Ex \ D1 \ \overline{D2} \\ & (64) \quad + \overline{03} \ 04 \ \overline{05} \ \overline{06} \ \overline{T_s} \ F3 \\ & (46) \quad + \overline{02} \ \overline{03} \ 04 \ \overline{T_s} \ C14 \end{aligned}$$

### High Power Drivers

$$Ap = An \ \overline{F1}$$

$$\overline{Ap} = (\overline{An} + F1) F3$$

$sAw =$   
 $+ \overline{Anr} An Ts$   
 $+ \overline{Anr} An \overline{Tp}$   
 $+ \overline{Anr} Aw Tp \overline{Ts}$   
(76)  $+ Anr 01 02 03 04 C23$   
(16-17)  $+ \overline{01} \overline{02} 03 04 \overline{06} 05 An \overline{C23}$   
(16-17)  $+ \overline{01} \overline{02} 03 04 \overline{06} 05 \overline{An} C23$   
(16, 14)  $+ \overline{01} \overline{02} 03 04 \overline{06} \overline{06} An C23$   
(66)  $+ \overline{03} 05 \overline{06} Ar \overline{S8} \overline{TI} \overline{T0}$   
(66)  $+ \overline{03} 05 \overline{06} Ae S8 \overline{T0}$   
(66)  $+ \overline{03} 05 \overline{06} (T1 \overline{S8} + T0) \overline{S1} Aw$   
(66)  $+ \overline{03} 05 \overline{06} (T1 \overline{S8} + T0) S1 Bn \overline{S3}$   
(67)  $+ \overline{03} 05 06 S4 S8$   
(67)  $+ \overline{03} 05 06 S5 \overline{S8}$   
(62)  $+ Anr C23 01 05 \overline{04}$   
(46)  $+ \overline{02} \overline{03} 04 \overline{Ts} C20 Bn$   
(46)  $+ \overline{02} \overline{03} 04 \overline{Ts} C16 Xn$   
 $+ Anr Ex C23$   
(65)  $+ \overline{03} \overline{05} 06 S4 \overline{S8}$   
(65)  $+ \overline{03} \overline{05} 06 S8 Bn \overline{S1}$   
(65)  $+ \overline{03} \overline{05} 06 S8 \overline{Bn} S1$   
(54-57)  $+ 01 \overline{02} 03 04 \overline{06} Add$   
(46)  $+ \overline{02} \overline{03} 04 \overline{Ts} C14 \overline{P0} An$   
(46)  $+ \overline{02} \overline{03} 04 \overline{Ts} C14 P0 \overline{An}$   
(64)  $+ \overline{01} Cz \overline{An} Anr$   
(64)  $+ \overline{01} \overline{Cz} An Anr$   
(64)  $+ Mt \overline{Cz} C23$   
(64)  $+ Mt Cz \overline{C23}$

## B REGISTER

$$\begin{aligned}
 sBe &= Br \overline{\{(\overline{03} \ 05 \ \overline{06}) (Q1 + Q2 + S8 \ \overline{Q3})\}} \overline{Mh} \\
 &+ Br \ S8 \ \overline{Mh} \\
 &+ Mt \ C14 \ M15(Ap. + \overline{F3})
 \end{aligned}$$

$$\begin{aligned}
 rBe &= \overline{Br} \overline{\{(\overline{03} \ 05 \ \overline{06}) (Q1 + Q2 + S8 \ \overline{Q3})\}} \overline{Mh} \\
 &+ \overline{Br} \ S8 \ \overline{Mh} \\
 &+ Mt \ \overline{C14} \ (\overline{M15} \ Ap) \\
 &+ \overline{05} \ \overline{06} \ \overline{Q3} \ T24 \\
 &+ Mt \ T0 \ F1
 \end{aligned}$$

$$\begin{aligned}
 sBn &= Be \overline{\{(\overline{03} \ 05 \ \overline{06}) (Q1 + Q2 + S8 \ \overline{Q3})\}} \overline{Mh} \\
 &+ Mt \ C15 \ M16(Ap. + \overline{F3})
 \end{aligned}$$

$$\begin{aligned}
 rBn &= \overline{Be} \overline{\{(\overline{03} \ 05 \ \overline{06}) (Q1 + Q2 + S8 \ \overline{Q3})\}} \overline{Mh} \\
 &+ Mt \ \overline{C15} \ (\overline{M16} \ Ap) \\
 &+ \overline{05} \ \overline{06} \ \overline{Q3} \ T24
 \end{aligned}$$

$$\begin{aligned}
 Bnr &= \\
 (75) &+ 01 \ 02 \ 03 \ 04 \ \overline{05} \ 06 \ \overline{06} \\
 (46) &+ \overline{02} \ \overline{03} \ 04 \ \overline{Ts} \ C22 \\
 (46) &+ \overline{02} \ \overline{03} \ 04 \ \overline{Ts} \ C21 \\
 (46) &+ \overline{02} \ \overline{03} \ 04 \ \overline{Ts} \ C18 \\
 &+ Ex \ \overline{D1} \ D2 \\
 &+ Ex \ (\text{Kb}) \\
 &+ \overline{03} \\
 (64) &+ \overline{03} \ 04 \ \overline{05} \ \overline{06} \ \overline{Ts} \ F2
 \end{aligned}$$

**sBw** =  
 + ~~Bnr~~ Bn  
 (75) + Bnr 03 C23  
 (46) +  $\overline{02} \overline{03} 04 \overline{Ts}$  C21 An  
 (46) +  $\overline{02} \overline{03} 04 \overline{Ts}$  C18 Xn  
 (66) +  $\overline{03} 05 \overline{06}$  Br  $\overline{S8} \overline{T0} \overline{T1} \overline{Mh}$   
 (66) +  $\overline{03} 05 \overline{06}$  Be S8  $\overline{T0}$   
 (66) +  $\overline{03} 05 \overline{06}$  An ( $\overline{S8} \overline{T1} + \overline{T0}$ )  
 (67) +  $\overline{03} 05 06$  S6 S8  
 (67) +  $\overline{03} 05 06$  S7  $\overline{S8}$   
 (65) +  $\overline{03} \overline{05} 06 \overline{S8}$  S6  
 + Bnr Ex C23  
 (65) +  $\overline{03} \overline{05} 06$  S8 S5 Ae  
 (64) + Mt An

## C REGISTER

	<b>■C0</b>	=
(30)		+ $\overline{\Phi 4} \overline{01} \overline{04} \overline{05} \textcircled{Yn}$
(37)		+ $\Phi 4 \overline{04} \overline{05} \overline{06} Xn$
(32)		+ $\Phi 4 \overline{01} \overline{04} \overline{05} \overline{06} Wn$
(33)		+ $\Phi 4 \overline{01} \overline{04} \overline{06} C23$
(35)		+ $\Phi 4 \overline{04} \overline{05} \overline{06} An$
(36)		+ $\Phi 4 \overline{04} \overline{05} \overline{06} Bn$
(62)		+ $\Phi 4 \overline{01} \overline{05} \overline{06} An$
(60, 61)		+ $\Phi 4 \overline{01} \overline{05} C23 \overline{Cz}$
(60, 61)		+ $\Phi 4 \overline{01} \overline{05} \overline{C23} Cz$
		+ $\overline{F1} \overline{F3} \overline{T8} C23 \overline{Mh}$
(01, 41, 43)		+ $\Phi 0 \overline{1a} \overline{02} \overline{03} P14 Q2$
(43)		+ $\Phi 0 \overline{1a} \overline{02} \overline{03} \text{ of } T0$
		+ $P0 \Phi 0 Q2 P14$
		+ $P0 \Phi 0 \text{ of } T0$
		+ $P0 \Phi 0 T9$
		+ $Ex D1 \overline{D2} An$
		+ $Ex \overline{D1} D2 Bn$
		+ $Ex D1 D2 Xn$
		+ $Ex \textcircled{Ka} An$
		+ $Ex \textcircled{Kb} Bn$
		+ $Ex \textcircled{Kx} Xn$
(63)		+ $\Phi 4 \overline{01} \overline{05} \overline{06} \text{ Add}$
		+ $\overline{P0} \Phi 0 \overline{[(\Phi 0 \overline{1a} \overline{02} \overline{03}) 01]} \text{ Add } Q2$
		+ $Cxm M0$
		+ $Cxi Cd0$
		+ $\textcircled{Kc0}$
		+ $Ts Wn Wp \overline{Tp}$
		+ $Ts \textcircled{Yn} \overline{Wp} \overline{Tp}$
		+ $Mt M0 Ap Go$

$$\begin{aligned}
sC1 &= Cs C0 \\
&+ Cxm M1 \\
&+ Cxi Cd1 \\
&+ \textcircled{Kc1} \\
&+ Mt J1
\end{aligned}$$

similarly C2-C23

Also sC4, sC5, sC7, sC22 with  $\textcircled{Kf}$

C register enable

$$\begin{aligned}
Cg &= Cs' \overline{Tp} \overline{T24} \\
&+ Cxm' Tp \\
&+ Cxi Q1 \\
(46) \quad &+ \overline{02} \overline{03} 04 \overline{Ts} Q1 Q4 C17 \\
&+ Mh \overline{Ts} \overline{Tp} \overline{T24} \\
(64, 66) \quad &+ \overline{06} 03 T24 \\
&+ \textcircled{Kf} Ht
\end{aligned}$$

Shift C

$$\begin{aligned}
Cs' &= Ts \\
(\overline{04}, \overline{06}) &+ F1 \overline{F3} \\
(\overline{00}, \overline{01}) &+ \overline{F1} \overline{F2} \\
(65) &+ (\overline{03} \overline{05} 06) \\
&+ Ex \\
&+ \textcircled{St} \\
&+ \textcircled{Kcr} \\
Cs &= \overline{Tp} \overline{T24} Cs'
\end{aligned}$$

### Transfer Memory to C

$$\begin{aligned} \text{Cxm}' &= \overline{\text{P0}} \overline{\text{Ø0}} \overline{\text{Ia}} \overline{\text{Ø2}} \overline{\text{Ø3}} \overline{\text{Ø1}} \overline{\text{Ø0}} \\ &+ \text{Tsm} \text{W9} \text{Wp} \text{Ts} \\ &+ \text{Tsm} (\text{Y9}) \overline{\text{Wp}} \text{Ts} \\ &+ \text{End Go} \\ &+ \overline{\text{Ht}} \text{Int} \overline{\text{D1}} \overline{\text{D2}} \overline{\text{Ts}} \overline{\text{Cp}} \\ \text{Cxm} &= \text{Cxm}' \text{Tp} \end{aligned}$$

### Transfer Inputs to C

$$\text{Cxi} = \text{Ø2} \text{Ø6} \text{Ø2}$$

### Parity Generation

$$\text{sC24} = \overline{\text{T23}} \overline{\text{T24}} \text{C0} \overline{\text{C24}}$$

$$\begin{aligned} \text{rC24} &= \text{T23} \\ &+ \overline{\text{T23}} \overline{\text{T24}} \text{C0} \text{C24} \\ &+ (\text{St}) \end{aligned}$$

### Parity Check

$$\begin{aligned} \text{sCp} &= \text{M24} \text{Tp} \overline{\text{Ht}} \overline{\text{Ts}} \\ &+ \overline{\text{Cp}} \text{C23} \overline{\text{Ht}} \overline{\text{Tp}} \overline{\text{T24}} (\overline{\text{F1}} \overline{\text{F2}} \overline{\text{Ts}} \overline{\text{Wp}} + \text{Ø4} \text{Ø1} + \text{Ø6} \text{Ø3}) \end{aligned}$$

$$\begin{aligned} \text{rCp} &= \overline{\text{C0}} \overline{\text{Ht}} \text{T24} \\ &+ \text{Cp} \text{C23} \overline{\text{Ht}} \overline{\text{Tp}} \overline{\text{T24}} (\overline{\text{F1}} \overline{\text{F2}} \overline{\text{Ts}} \overline{\text{Wp}} + \text{Ø4} \text{Ø1} + \text{Ø6} \text{Ø3}) \\ &+ (\overline{\text{F1}} \overline{\text{F2}} \overline{\text{Ts}} \overline{\text{Wp}} + \text{Ø4} \text{Ø1} + \text{Ø6} \text{Ø3}) \overline{\text{Ts}} \overline{\text{Ht}} \text{T0} \end{aligned}$$

$$+ (\text{St})$$

$$+ (\overline{\text{Kp}}) \text{Ht}$$

Parity error light = Cp Ht

Halt light =  $\overline{\text{Cp}}$  Ht



Carry

$$\begin{aligned} sCz &= \\ (56, 57) &+ Tp \overline{00} 01 \overline{02} 04 05 Xw \\ (\overline{00}, \overline{04}, \overline{06}) &+ \overline{F3} \overline{Tp} \overline{T24} \overline{T0} Xz Yz \overline{Cz} \overline{Ts} \\ (54, 74) &+ \overline{06} T24 \overline{05} \overline{06} 04 \\ (60, 61) &+ \overline{01} \overline{05} \overline{04} T24 \\ (65) &+ \overline{05} 06 \overline{03} \overline{T24} \overline{S1} Xz Yz \overline{Cz} \\ (65) &+ \overline{05} 06 \overline{03} \overline{T24} S1 \overline{Xz} Yz \\ (64) &+ \overline{01} Rf An \overline{T24} \\ (64) &+ Mt Rf Cz3 \end{aligned}$$

$$\begin{aligned} rCz &= \\ &+ T0 \overline{F3} \overline{Ts} \overline{F1} \\ &+ \overline{00} \overline{Ix} \overline{Tp} \\ (\overline{00}, \overline{04}, \overline{06}) &+ \overline{F3} \overline{T24} \overline{Xz} \overline{Yz} \overline{Cz} \overline{Ts} \\ (65) &+ \overline{05} 06 \overline{03} \overline{S1} \overline{Xz} \overline{Yz} Cz \\ (65) &+ \overline{05} 06 \overline{03} S1 Xz \overline{Yz} \\ &+ \overline{03} T24 \\ &+ (\text{St}) \end{aligned}$$

## Multiply (MUL) Carry Flip-Flops

$$\begin{aligned} sD1 &= Ex T0 \overline{D1} \textcircled{Kb} \\ &+ Ex T0 \overline{D1} \textcircled{Kx} \\ &+ Mt C17 M18 (Ap + \overline{F3}) \end{aligned}$$

$$\begin{aligned} rD1 &= Ex T0 D1 \\ &+ Mt \overline{C17} (\overline{M18} Ap) \\ &+ (\emptyset 0 Go) \end{aligned}$$

$$\begin{aligned} sD2 &= Ex T0 \overline{D2} \textcircled{Kb} \\ &+ Ex T0 \overline{D2} \textcircled{Kx} \\ &+ Mt C18 M19 (Ap + \overline{F3}) \end{aligned}$$

$$\begin{aligned} rD2 &= (Ex T0) D2 \\ &+ Mt \overline{C18} (\overline{M19} Ap) \overline{03} \\ &+ \emptyset 0 Go \end{aligned}$$

$$sD3 = Mt C19 M20 (Ap + \overline{F3})$$

$$rD3 = Mt \overline{C19} (\overline{M20 Ap}) \\ + \emptyset 0 Go$$

$$sD4 = Mt C20 M21 (Ap + \overline{F3})$$

$$rD4 = Mt \overline{C20} (\overline{M21 Ap}) \\ + \emptyset 0 Go$$

$$sD5 = Mt C21 M22 (Ap + \overline{F3})$$

$$(65) + \emptyset 3 \overline{05} 06 Tp$$

$$rD5 = Mt \overline{C21} (\overline{M22 Ap}) \\ + \emptyset 0 Go$$

$$sD6 = Mt C22 M23 (Ap + \overline{F3})$$

$$rD6 = Mt \overline{C22} (\overline{M23 Ap}) \\ + \emptyset 0 Go$$

## End

$$\begin{aligned}\text{End} &= \\ (\phi 5 \phi 7) &+ F1 F3 \overline{T_s} \\ (\phi 6 \phi 7) &+ F1 F2 \overline{T_s} \\ (01) &+ \phi 0 \overline{I_a} \overline{02} \overline{03} \overline{01}\end{aligned}$$

## Enable

$$\begin{aligned}s\text{En} &= \text{Eom} C10 \overline{C11} C22 T_o \\ r\text{En} &= \text{Eom} C10 \overline{C11} C21 \\ &+ (\text{St})\end{aligned}$$

## Eom Signals

$$\text{Eom} = \phi 5 \overline{01} 05$$

## System Communications

$$(\text{Sys}) = \phi 5 \overline{01} 05 \overline{C9} C10 C11 Q1$$

## Input/Output Control

$$\text{Ioc} = \phi 5 \overline{01} 05 \overline{C10} C11 Q1$$

## Buffer Control

$$\text{Buc} = \phi 5 \overline{01} 05 \overline{C10} C11$$

Exchange C and A, B or X

$$\begin{aligned}
 sEx = \overline{T_s} \textcircled{Kf} T24 \overline{Go} \overline{Ht} & \left[ D1 ( \textcircled{Ks} + \textcircled{Kg} + \textcircled{Kc'} ) \right. \\
 & + D2 ( \textcircled{Ks} + \textcircled{Kg} + \textcircled{Kc'} ) \\
 & + D1 \textcircled{Kb} \\
 & + D2 \textcircled{Ka} \\
 & + \overline{D1} \textcircled{Ka} \\
 & + \overline{D1} \textcircled{Kx} \\
 & + \overline{D2} \textcircled{Kx} \\
 & \left. + \overline{D2} \textcircled{Kb} \right]
 \end{aligned}$$

$$rEx = T0 F1$$

Phase Flip-Flops

$$\begin{aligned}
 sF1 & = T_p \overline{T_s} (Sk + P0 + \emptyset4) \\
 & + T_p \overline{Ia} \emptyset0 \ 03 \ 04 \\
 & + T_p \overline{Ia} \emptyset0 \ 01 \ \overline{04} \\
 & + T_p \overline{F1} \ \overline{F3} \ \overline{01} \ \overline{03} \ \overline{04} \ \overline{Ia} \ \overline{T_s} \ Rf \\
 & + T24 \ \overline{Go} \\
 & + \emptyset0 \ T24 \ \overline{Ia} \ \overline{Go} \ \overline{C5} \ \overline{C8} \ \overline{C2} \ (\overline{C3} + \overline{C4}) \\
 rF1 & = T_p \ \text{End} \ \overline{Sk}
 \end{aligned}$$

$$\begin{aligned}
sF2 &= \\
&+ T_p \overline{T_s} (S_k + P_0 + \Phi_4) \\
(41, 43) &+ T_p \overline{I_a} \Phi_0 01 \overline{02} \\
(1-, 3-, &+ T_p \overline{I_a} \Phi_0 03 \\
5-, 7-) &+ \Phi_1 T_p \\
rF2 &= T_p \text{ End } \overline{S_k} \\
&+ T_{24} \Phi_6 \overline{01} 02 03 \\
sF3 &= \\
&+ T_p \overline{T_s} (S_k + P_0 + \Phi_4) \\
&+ T_{24} \overline{I_a} \Phi_0 G_0 \overline{C_5} \overline{C_8} \overline{C_2} (\overline{C_3} + \overline{C_4}) \\
&+ T_{24} \overline{G_0} \\
(64-67) &+ T_p \overline{I_a} \Phi_0 02 \overline{03} 04 \\
(66, 67) &+ T_9 05 \overline{I_a} \Phi_0 02 \overline{03} 04 \\
rF3 &= T_p \text{ End } \overline{S_k}
\end{aligned}$$

Phases

$$\begin{aligned}
\Phi_0 &= \overline{F_1} \overline{F_2} \overline{F_3} \overline{T_s} \\
\Phi_1 &= \overline{F_1} \overline{F_2} \overline{F_3} \overline{T_s} \\
\Phi_2 &= \overline{F_1} \overline{F_2} \overline{F_3} \overline{T_s} \\
\Phi_3 &= \overline{F_1} \overline{F_2} \overline{F_3} \overline{T_s} \\
\Phi_4 &= \overline{F_1} \overline{F_2} \overline{F_3} \overline{T_s} \\
\Phi_5 &= \overline{F_1} \overline{F_2} \overline{F_3} \overline{T_s} \\
\Phi_6 &= \overline{F_1} \overline{F_2} \overline{F_3} \overline{T_s} \\
\Phi_7 &= \overline{F_1} \overline{F_2} \overline{F_3} \overline{T_s}
\end{aligned}$$

## Control Flip-Flops

$$\begin{aligned}
 sGo &= \overline{D1} \overline{D2} \overline{T_s} T_p \overline{Ht} ( \textcircled{K_s} + \textcircled{K_g} Mg \textcircled{\overline{K_f}} ) \\
 rGo &= T_p \text{End} \overline{Sk} Ht \\
 &+ \textcircled{St} \\
 sHt &* \\
 (\text{external halt}) &+ \overline{T_s} \textcircled{H} T0 \overline{Int} \\
 (00) &+ \overline{\phi 5} T0 \overline{01} \overline{02} \overline{05} \overline{Int} \\
 &+ \textcircled{\overline{K_g}} Go T0 \text{End} \\
 &+ C_p T_p \textcircled{K_p} \overline{T_s} \\
 &+ \textcircled{St} \\
 rHt &= \textcircled{\overline{K_s}} \textcircled{\overline{K_g}} \overline{Go} \overline{C_p} T24 \\
 &+ \textcircled{K_g} Int \overline{C_p} \\
 &+ \textcircled{K_f} \overline{Wp}
 \end{aligned}$$

## Indirect Addressing

$$\begin{aligned}
 sIa &= \overline{\phi 0} \overline{Ia} T24 Go \overline{C2} C9 \\
 &+ T24 \overline{\phi 7} Sk \\
 (\phi 4, \phi 6) &+ T24 F1 \overline{F3} \textcircled{I_j} \\
 &+ \overline{\phi 0} \overline{Ia} T24 Go \overline{C2} \overline{C5} \overline{C8} (\overline{C3} + \overline{C4}) \\
 (\phi 1, \phi 3) &+ \overline{F1} F3 \overline{T_s} Aw T1 \\
 rIa &= T24 \overline{\phi 0} Go \overline{C9} Ia \\
 (41, 51) &+ \overline{C23} \overline{\phi 6} \overline{01} \overline{02} \overline{04} \overline{05} \overline{06} \overline{T24} \\
 &+ \overline{P14} F1 (\overline{\phi 6} \overline{01} \overline{02} \overline{04} \overline{05} \overline{06}) \overline{T24} Go \\
 &+ T0 F1 \\
 &+ T24 \overline{\phi 3}
 \end{aligned}$$

## Interrupt

$$sInt = T10 Ir \text{ End } (En + \textcircled{En}) \overline{Ecm} + \text{End } T10 Is$$

$$rInt = T10 \text{ Int } \overline{F1}$$

$$+ \textcircled{St} T10$$

$$Ir = \overline{\textcircled{Ir}}$$

$$Is = \overline{\textcircled{Is}}$$

## Interrupt Subroutine Exit

$$\begin{aligned} Ib = & \textcircled{00} Ia \overline{01} \overline{02} \overline{03} 06 (T22 - T17) \\ & + \textcircled{St} (T22 - T17) \\ & + Ij (T22 - T17) F1 \overline{Ts} \end{aligned}$$

## Interrupt Subroutine Entry

$$Ie = \text{Int } \overline{F1}, (T22 - T17)$$

## Index Flip-Flop

$$\begin{aligned} sIx &= \textcircled{00} T24 C1 \\ (67) &+ 05 06 \textcircled{03} T23 \overline{S8} \\ (67) &+ 05 06 \textcircled{03} T24 S8 \\ (46) &+ \overline{02} \overline{03} 04 \overline{Ts} Q1 Q4 C17 Xnr \end{aligned}$$

$$\begin{aligned} (54-57) &+ 01 \overline{02} 03 04 \textcircled{06} T14 Cz \\ (64) &+ Mt C16 M17 (Ap + \overline{F3}) \end{aligned}$$

$$\begin{aligned} rIx &= \\ (67) &+ 05 06 \textcircled{03} T24 Ix Xn \\ (66, 67) &+ \textcircled{00} \overline{Ia} 02 \overline{03} 04 05 Q1 \\ &+ Tp \overline{Mh} \\ &+ \textcircled{St} \\ &+ Mt T0 F1 \\ (64) &+ Mt C16 (\overline{M17} Ap) \end{aligned}$$



Multiply (MUL) Adders

$$J1 = C0 S1 (M1 Ap) + C0 \overline{S1} \overline{M1 (Ap + \overline{F3})} + \overline{C0} S1 \overline{M1 (Ap + \overline{F3})} + \overline{C0} \overline{S1} (M1 Ap)$$

$$J2 = C1 S2 (M2 Ap) + C1 \overline{S2} \overline{M2 (Ap + \overline{F3})} + \overline{C1} S2 \overline{M2 (Ap + \overline{F3})} + \overline{C1} \overline{S2} (M2 Ap)$$

•            •            •            •            •  
 •            •            •            •            •  
 •            •            •            •            •  
 •            •            •            •            •  
 •            •            •            •            •  
 •            •            •            •            •

$$J14 = C13 S14 (M14 Ap) + C13 \overline{S14} \overline{M14 (Ap + \overline{F3})} + \overline{C13} S14 \overline{M14 (Ap + \overline{F3})} + \overline{C13} \overline{S14} (M14 Ap)$$

$$J15 = C14 Be (M15 Ap) + C14 \overline{Be} \overline{M15 (Ap + \overline{F3})} + \overline{C14} Be \overline{M15 (Ap + \overline{F3})} + \overline{C14} \overline{Be} (M15 Ap)$$

$$J16 = C15 Bn (M16 Ap) + - - -$$

$$J17 = C16 Ix (M17 Ap) + - - -$$

$$J18 = C17 D1 (M18 Ap) + - - -$$

$$J19 = C18 D2 (M19 Ap) + - - -$$

$$J20 = C19 D3 (M20 Ap) + - - -$$

$$J21 = C20 D4 (M21 Ap) + - - -$$

$$J22 = C21 D5 (M22 Ap) + - - -$$

$$J23 = C22 D6 (M23 Ap) + - - -$$

Address Lines to Memory

$$\overline{L1} = S1 \overline{Tsm} + \textcircled{Iw 10} Tsm Wp + \textcircled{Iy 10} Tsm \overline{Wp}$$

$$\overline{L2} = S2 \overline{Tsm} + \textcircled{Iw 11} Tsm Wp + \textcircled{Iy 11} Tsm \overline{Wp}$$

$$\overline{L14} = S14 \overline{Tsm} + \textcircled{Iw 23} Tsm Wp + \textcircled{Iy 23} Tsm \overline{Wp}$$

Also provide  $\overline{L3}$  through  $\overline{L13}$ .

Clear M

$$\begin{aligned} Mc &= Tp PO \\ &+ Tp \overline{O4} \\ (43) \quad &+ Tp \overline{O0} \overline{Ia} \overline{O2} \overline{O3} \overline{O5} \\ &+ Tp Tsm Wp \overline{W9} Ts \\ &+ Tp Tsm \overline{Wp} \textcircled{Y9} Ts \\ &+ Q1 \overline{Q2} \overline{Q3} \overline{Q4} \overline{Q5} (\overline{F1} \overline{F3} \overline{Ts}) (Tsm + \overline{Ts}) \\ &+ Tp Ts \overline{Tsm} \overline{F3} \overline{O6} \end{aligned}$$

Load C to M

$$Mxc = T24 P0$$

### Memory Pulse

$$\begin{aligned} sMg &= Mc Q1 \textcircled{Ms} \overline{T} \\ rMg &= Mg Q2 Q1 Q3 \overline{Q4} \end{aligned}$$

### Read Timing

$$Mrt = Mg \overline{Q2} (\overline{Q3} + Q4)$$

### Write Timing

$$Mwt = Mg Q2 (Mdt Q1 + \overline{Q3} Q5)$$

### Digit Timing

$$Mdt = Mg Q2 \overline{Q3} + Mg Q2 Q4$$

$$Rw = Mg \overline{Q2}$$

$$Wr = Mg Q2 (Mdt + Q1)$$

### Memory Strobe

$$Ms = Mg T2 = Mg (T5 - T0) \overline{Q4} \overline{Q5} Q1$$

$$Mt = \overline{Q3} Q4 \overline{Q5} \overline{Q6} F2 \overline{T_p} \overline{T_{24}} \overline{T_s}$$

$$Mu = \overline{Q3} Q4 \overline{Q5} \overline{Q6} F2 \overline{T_p} \overline{T_{24}} \overline{T_s} (\overline{F1} + Q2)$$

### Multiply Hold

$$\overline{Mh} = \overline{Q3} Q4 \overline{Q5} \overline{Q6} F2$$

Memory Register Logic (25 flip-flops)

$$\begin{aligned} sM0 &= Mxc C0 \\ &+ Ms Md0 \\ rM0 &= Mc \end{aligned}$$

$$\begin{aligned} sM1 &= Mxc C1 \\ &+ Ms Md1 \\ rM1 &= Mc \end{aligned}$$

and similar equations for M2 through M23:

$$\begin{aligned} sM24 &= Mxc C24 \\ &+ Ms Md24 \\ rM24 &= Mc \end{aligned}$$

The 0 Register

Clear 0

$$\begin{aligned} 0c &= Tp \text{ End } \overline{Sk} \\ (23) \quad &+ \overline{01} \overline{03} \overline{05} Tp \overline{Ia} \end{aligned}$$

Transfer C to 0

$$0xc = \overline{00} T24 \overline{Ia} Go \overline{C2}$$

s01 = 0xc C3

r01 = 0c

+ Xnr 02 04 Xw Mc Q1

s02 = 0c

r02 = 0xc C4

s03 = 0xc C5

r03 = 0c

s04 = 0xc C6

r04 = 0c

s05 = 0xc C7

r05 = 0c

s06 = 0xc C8

r06 = 0c

Overflow Flip-Flop

sOf	*
(54 - 57)	+ 01 $\overline{02}$ 03 04 $\emptyset$ 6 T0 $\overline{Xz}$ $\overline{Yz}$ Cz
(54 - 57)	+ 01 $\overline{02}$ 03 04 $\emptyset$ 6 T0 Xz Yz $\overline{Cz}$
(60, 61, 63)	+ $\overline{03}$ $\emptyset$ 4 T0 ( $\overline{05} + 06$ ) $\overline{Xz}$ $\overline{Yz}$ Cz
(63)	+ (01 05 $\emptyset$ 4 06 T0 Xz Yz $\overline{Cz}$
(67)	+ $\emptyset$ 3 05 06 $\overline{S1}$ T0 An $\overline{S4}$
(67)	+ $\emptyset$ 3 05 06 $\overline{S1}$ T0 $\overline{An}$ S4
(67)	+ $\emptyset$ 3 05 06 $\overline{S1}$ T0 $\overline{S8}$ An $\overline{S5}$
(67)	+ $\emptyset$ 3 05 06 $\overline{S1}$ T0 $\overline{S8}$ $\overline{An}$ S5
(65)	+ $\emptyset$ 3 $\overline{05}$ 06 $\overline{S8}$ Tp An $\overline{S4}$
(65)	+ $\emptyset$ 3 $\overline{05}$ 06 $\overline{S8}$ Tp $\overline{An}$ S4
(65)	+ $\emptyset$ 3 $\overline{05}$ 06 $\overline{S8}$ Tp $\overline{An}$ $\overline{S5}$ Ar
(65)	+ $\emptyset$ 3 $\overline{05}$ 06 S8 $\overline{Bn}$ S1 T0
(51)	+ $\emptyset$ 6 01 $\overline{02}$ $\overline{04}$ $\overline{05}$ 06 03 C0 T24
(64)	+ Mt T0 F1 Rf C23 $\overline{Cz}$
(65)	+ $\emptyset$ 3 $\overline{05}$ 06 Tp S4 $\overline{S5}$ $\overline{D5}$

rOf	=
(56 - 57)	+ Tp $\emptyset$ 0 01 $\overline{02}$ 04 05
	+ $\emptyset$ 5 01 $\overline{04}$ T0 C10 $\overline{C11}$ C23
	+ (St)
	+ EOM C10 $\overline{C11}$ C23
	+ $\emptyset$ 0 P0 T0

Pin, Pot

$$\text{Pin} = \text{Cxi Q1}$$

$$\text{Pot 1} = \overline{\text{F1}} \text{ F2 } \overline{\text{F3}} \overline{\text{Ts}} \overline{\text{O2}} \text{ O6}$$

$$\text{Pot 2} = \text{O2 O6 } \overline{\text{O2}} \text{ Q1}$$

Computer to Computer

$$\text{Rti} = \text{O4 } \overline{\text{O1}} \overline{\text{O4}} \text{ O6}$$

Programmed Operator

$$\text{sP0} = \text{O0 Ia T24 Go C2}$$

$$+ \text{Mc Tp}$$

$$(46) + \overline{\text{O2}} \overline{\text{O3}} \text{ O4 } \overline{\text{Ts}} \overline{\text{Tp}} \overline{\text{T0}} \text{ An}$$

$$\text{rP0} = \text{P0 T24}$$

$$+ \text{(St)}$$

$$(46) + \overline{\text{O2}} \overline{\text{O3}} \text{ O4 } \overline{\text{Ts}} \text{ T0}$$

P register enable

= Pg

Pg

= (Kr) Q2  $\overline{T_s}$  Go F1

+ (Kr) Q2  $\overline{T_s}$ Go (P0  $\overline{\Phi 0}$ )

(01, 41,  
43)

+ (Kr) Q2  $\overline{T_s}$  Go ( $\overline{\Phi 0}$   $\overline{I_a}$   $\overline{O2}$   $\overline{O3}$ )

+ (St)

sP1

= P0  $\overline{\Phi 0}$   $\overline{Q1}$  Q2 C8

(01, 41, 43)

+  $\overline{\Phi 0}$   $\overline{I_a}$   $\overline{O2}$   $\overline{O3}$  Add

(41, 51)

+  $\overline{\Phi 6}$  01  $\overline{O2}$   $\overline{O4}$   $\overline{O5}$  06 C23  $\overline{I_a}$

(41, 51)

+  $\overline{\Phi 6}$  01  $\overline{O2}$   $\overline{O4}$   $\overline{O5}$  06  $\overline{C23}$   $\overline{I_a}$

+ F1 ( $\overline{\Phi 6}$  01  $\overline{O2}$   $\overline{O4}$   $\overline{O5}$  06)  $\overline{I_a}$  P14 Go

+ F1 ( $\overline{\Phi 6}$  01  $\overline{O2}$   $\overline{O4}$   $\overline{O5}$  06)  $\overline{I_a}$   $\overline{P14}$  Go

sP2

= P1

sP3

= P2

,

,

,

,

,

,

sP14

= P13



### Pulse Counter

$$sQ1 = \overline{Q3} Q5 Q6$$

$$rQ1 = \overline{Q3} \overline{Q4} \overline{Q5}$$

$$sQ2 = \overline{Q1} \overline{Q5} \overline{Q6}$$

$$rQ2 = Q1 \overline{Q4} \overline{Q5}$$

$$sQ3 = \overline{Q3} Q4 \overline{Q5} \overline{Q6} + T0$$

$$rQ3 = Q3 Q4 \overline{Q5} \overline{Q6}$$

$$sQ4 = \overline{Q4} Q5 \overline{Q6} Q1 + Q3 \overline{Q4} Q5 \overline{Q6}$$

$$rQ4 = Q4 Q5 \overline{Q6}$$

$$sQ5 = \overline{Q5} Q6$$

$$rQ5 = Q5 Q6 Q1 + Q3 Q5 Q6$$

$$sQ6 = \overline{Q6}$$

$$rQ6 = Q6$$

Pulse Timing

$$\begin{aligned}
 (T23-T10) &= Q2 \\
 (T9) &= Q1 \overline{Q2} Q3 \overline{Q4} \overline{Q5} \\
 T1 &= \overline{Q1} \overline{Q3} \overline{Q4} Q5 \\
 T0 &= \overline{Q1} \overline{Q2} \overline{Q3} Q5 \\
 Tp &= \overline{Q1} \overline{Q2} Q3 Q5 \\
 T24 &= \overline{Q1} \overline{Q2} Q3 \overline{Q5} \\
 T23 &= \overline{Q1} Q2 \overline{Q4} \overline{Q5} \\
 (T22-T17) &= \overline{Q1} Q2 \overline{T23} \\
 (\overline{Tp} \overline{T24}) &= \overline{Q1} \overline{Q2} Q3 \\
 T21 + T22 &= \overline{Q1} Q2 Q3 Q5 \\
 T10 &= Q1 Q2 \overline{Q4} \overline{Q5} \\
 (T5-T0) &= \overline{Q2} \overline{Q3} \\
 T14 &= Q1 Q2 \overline{Q3} \overline{Q5}
 \end{aligned}$$

Ready Flip-Flop

$$\begin{aligned}
 sRf &= \\
 (64) &+ \overline{03} 04 \overline{05} \overline{06} Tp \overline{00} Aw \\
 &+ \overline{01} 03 \overline{04} \overline{Ia} \overline{F1} \overline{F3} \overline{Ts} \overline{Wf} (W0 + W9) 05 \overline{06} \\
 &+ \overline{01} 03 \overline{04} \overline{Ia} \overline{F1} \overline{F3} \overline{Ts} \boxed{Yf (Y0 + Y9)} \overline{05} \\
 &+ \overline{01} 03 \overline{04} \overline{Ia} \overline{F1} \overline{F3} \overline{Ts} Q2 \overline{02} 06 Rt \\
 rRf &= Tp \text{ End } \overline{Sk}
 \end{aligned}$$

Clear S

$$S_c = T_{10} (\text{End} + \overline{T_s} \overline{F_1} \overline{F_2})$$

Transfer C to S

$$S_{xc} = T_9 \overline{\phi_0} \overline{P_0} (\overline{\phi_0} \overline{I_a} \overline{O_2} \overline{O_3})$$

Transfer P to S

$$S_{xp} = T_9 \overline{\text{Int}} (\text{End} + \overline{O_2} \overline{O_3} \overline{I_a} \overline{\phi_0})$$

Interrupt (N) to S

$$S_{xn} = T_9 \overline{\text{Int}} \overline{T_s}$$

Count S down

$$S_s = \overline{\phi_3} T_{23} \overline{M_h}$$

## S REGISTER

sS1 =

+ C0 Sxc

+ P1 Sxp

(65) +  $\overline{05} 06 \overline{01} T_p Aw C0$

(65) +  $\overline{05} 06 \overline{01} T_p \overline{Aw} \overline{C0}$

(65) +  $\overline{03} \overline{05} 06 T24 S8 S5 \overline{S1}$

(64) + Mu C0 ( $\overline{M1} \overline{Ap}$ )

rS1 = Sc

(65) +  $\overline{03} \overline{05} 06 T24 S8 S5 S1$

(65) +  $\overline{03} \overline{05} 06 S1 \overline{Bn} S8 \overline{T24}$

(64) + Mu  $\overline{C0} M1 (Ap + \overline{F3})$

$$\begin{aligned}
sS2 &= \\
&+ C1 Sxc \\
&+ P2 Sxp \\
(65) &+ \overline{\emptyset 3} \overline{05} \overline{06} \overline{T24} \overline{Tp} \overline{S8} \overline{C23} \overline{S4} \overline{S1} \\
(65) &+ \overline{\emptyset 3} \overline{05} \overline{06} \overline{T24} \overline{Tp} \overline{S8} \overline{C23} \overline{S4} S1 \\
(65) &+ \overline{\emptyset 3} \overline{05} \overline{06} \overline{Tp} \overline{C0} \overline{S2} \\
(64) &+ \text{Mu } C1 \overline{M2(Ap + F3)}
\end{aligned}$$

$$\begin{aligned}
rS2 &= \\
&+ Sc \\
(65) &+ \overline{\emptyset 3} \overline{05} \overline{06} \overline{T24} \overline{Tp} \overline{S8} \overline{C23} \overline{S4} S1 \\
(65) &+ \overline{\emptyset 3} \overline{05} \overline{06} \overline{T24} \overline{Tp} \overline{S8} \overline{C23} \overline{S4} \overline{S1} \\
(65) &+ \overline{\emptyset 3} \overline{05} \overline{06} T24 \\
(65) &+ \overline{\emptyset 3} \overline{05} \overline{06} \overline{Tp} \overline{C0} S2 \\
(64) &+ \text{Mu } \overline{C1} (\overline{M2 Ap})
\end{aligned}$$

$$\begin{aligned}
sS3 &= \\
&+ C2 Sxc \\
&+ P3 Sxp \\
(65) &+ \overline{05} \overline{06} \overline{\emptyset 3} \overline{T24} \overline{S2} \\
(64) &+ \text{Mu } C2 \overline{M3(Ap + F3)}
\end{aligned}$$

$$\begin{aligned}
rS3 &= Sc \\
(65) &+ \overline{05} \overline{06} \overline{\emptyset 3} \overline{Tp} \\
(64) &+ \text{Mu } \overline{C2} (\overline{M3 Ap})
\end{aligned}$$

**sS4**            = C3 Sxc  
                   + P4 Sxp  
 (67)            + 06 05  $\overline{T_p}$   $\overline{T_{24}}$   $\overline{T_0}$   $\overline{\phi_3}$  An  
 (67)            +  $\overline{F_1}$  F3 05 06  $\overline{T_s}$   $\overline{Q_1}$   $\overline{Q_2}$  Q5 Bw  
 (65, 67)        +  $\overline{F_1}$  F3  $\overline{T_s}$  06 Tp Bw  
 (65)            +  $\overline{\phi_3}$   $\overline{05}$  06  $\overline{S_8}$   $\overline{T_p}$   $\overline{T_{24}}$  Add  
 (64)            + Mu C3 M4 (Ap +  $\overline{F_3}$ )

**rS4**            = Sc  
 (67)            + 06 05  $\overline{T_p}$   $\overline{T_{24}}$   $\overline{T_0}$   $\overline{\phi_3}$  An  
 (65, 67)        +  $\overline{F_1}$  F3  $\overline{T_s}$  06 Tp  $\overline{B_w}$   
 (67)            +  $\overline{F_1}$  F3  $\overline{T_s}$  05 06  $\overline{Q_1}$   $\overline{Q_2}$  Q5  $\overline{B_w}$   
 (65)            +  $\overline{\phi_3}$   $\overline{05}$  06  $\overline{S_8}$   $\overline{T_p}$   $\overline{T_{24}}$   $\overline{Add}$   
 (64)            + Mu  $\overline{C_3}$  ( $\overline{M_4}$  Ap)

**sS5 = N5 Sxn**

**+ C4 Sxc**

**+ P4 Sxp**

(67) +  $\overline{F1} \overline{F3} \overline{Ts} \overline{05} \overline{06} \overline{T24} \overline{S4}$

(65) +  $\overline{03} \overline{05} \overline{06} \overline{S8} \overline{T24} \overline{Tp}$  Add C23 S7

(65) +  $\overline{03} \overline{05} \overline{06} \overline{S8} \overline{T24} \overline{Tp}$  Add  $\overline{C23} \overline{S7}$

(65) +  $\overline{03} \overline{05} \overline{06} \overline{S8} \overline{T24} \overline{Tp}$  Add  $\overline{C23} \overline{S7}$

(65) +  $\overline{03} \overline{05} \overline{06} \overline{S8} \overline{T24} \overline{Tp}$  Add  $\overline{C23} \overline{S7}$

(64) + Mu C4 (M5(Ap + F3))

**rS5 = Sc**

(65) +  $\overline{03} \overline{05} \overline{06} \overline{T24} \overline{S8}$

(67) +  $\overline{F1} \overline{F3} \overline{Ts} \overline{05} \overline{06} \overline{T24} \overline{S4}$

(64) + Mu  $\overline{C4}(\overline{M5} \overline{Ap})$

$$\begin{aligned}
sS6 &= N6 Sxn \\
&+ C5 Sxc \\
&+ P6 Sxp \\
(65, 67) &+ \overline{\emptyset 3} \overline{T_p} \overline{T_{24}} \overline{T_0} \overline{06} \overline{B_n} \\
(67) &+ \overline{F_1} \overline{F_3} \overline{T_s} \overline{05} \overline{06} \overline{Q_1} \overline{Q_2} \overline{Q_5} \overline{A_w} \overline{S_1} \\
(65) &+ \overline{\emptyset 3} \overline{05} \overline{06} \overline{T_{24}} \overline{S_1} \overline{S_2} \\
(65) &+ \overline{\emptyset 3} \overline{05} \overline{06} \overline{T_{24}} \overline{S_1} \overline{S_2} \\
(64) &+ \text{Mu } C5 M6 (A_p + \overline{F_3})
\end{aligned}$$

$$\begin{aligned}
rS6 &= Sc \\
(65) &+ \overline{F_1} \overline{F_3} \overline{T_s} \overline{06} \overline{T_p} \overline{05} \\
(65, 67) &+ \overline{\emptyset 3} \overline{T_p} \overline{T_{24}} \overline{T_0} \overline{06} \overline{B_n} \\
(67) &+ \overline{F_1} \overline{F_3} \overline{T_s} \overline{05} \overline{06} \overline{Q_1} \overline{Q_2} \overline{Q_5} \overline{A_w} \overline{S_1} \\
(64) &+ \text{Mu } \overline{C_5} (\overline{M_6} \overline{A_p}) \\
(67) &+ \overline{F_1} \overline{F_3} \overline{T_s} \overline{05} \overline{06} \overline{Q_1} \overline{Q_2} \overline{Q_5} \overline{S_1}
\end{aligned}$$



$$\begin{aligned}
sS7 &= N7 Sxn \\
&+ C6 Sxc \\
&+ P7 Sxp \\
(67) &+ \overline{F1} F3 \overline{Ts} 05 06 \overline{T24} S6 \\
(65) &+ \emptyset 3 \overline{05} 06 \overline{S8} \overline{Tp} \overline{T24} C23 \overline{S1} \\
(64) &+ Mu C6 M7 (Ap + \overline{F3}) \\
(65) &+ \emptyset 1 \overline{05} 06 Tp Aw
\end{aligned}$$

$$\begin{aligned}
rS7 &= \\
&+ Sc \\
(67) &+ \overline{F1} F3 \overline{Ts} 05 06 \overline{T24} \overline{S6} \\
(65) &+ \emptyset 3 \overline{05} 06 Tp \\
(64) &+ Mu \overline{C6} (\overline{M7 Ap}) \\
(65) &+ \emptyset 3 \overline{05} 06 \overline{S8} \overline{Tp} \overline{T24} C23 S1
\end{aligned}$$

$$\begin{aligned}
sS8 &= N8 Sxn \\
&+ C7 Sxc \\
&+ P8 Sxp \\
(65, 66, 67) &+ \overline{F1} F3 \overline{Ts} Tp \overline{S9} \overline{S10} \overline{S11} \overline{S12} \overline{S13} \overline{04} \overline{05} \overline{06} \\
(67) &+ \overline{F1} F3 05 06 \overline{Ts} S2 T0 An \overline{Ia} \\
(67) &+ \overline{F1} F3 05 06 \overline{Ts} S2 T0 \overline{An} Ia \\
(64) &+ Mu C7 M8 (Ap + \overline{F3})
\end{aligned}$$

$$\begin{aligned}
rS8 &= Sc \\
(64) &+ Mu \overline{C7} (\overline{M8 Ap})
\end{aligned}$$

$$\begin{aligned}
 sS9 &= \\
 &+ C8 Sxc \\
 &+ P9 Sxp \\
 &+ N9 Sxn \\
 (65) &+ \overline{05} \ 06 \ \emptyset 1 \ T0 \\
 (64) &+ \text{Mu } C8 \ M9 \ (Ap + \overline{F3})
 \end{aligned}$$

$$\begin{aligned}
 rS9 &= \\
 &+ Ss \ S9 \ \overline{S10} \ \overline{S11} \ \overline{S12} \ \overline{S13} \\
 (64) &+ \text{Mu } \overline{C8} \ (\overline{M9} \ Ap) \\
 &+ Sc
 \end{aligned}$$

$$\begin{aligned}
sS10 &= \\
&+ C9 Sxc \\
&+ P10 Sxp \\
&+ N10 Sxn \\
&+ Ss \overline{S10} \overline{S11} \overline{S12} \overline{S13} \\
(65) &+ \overline{05} \overline{06} \overline{01} \overline{T0} \\
(64) &+ Mu C9 M10 (Ap + \overline{F3})
\end{aligned}$$

$$\begin{aligned}
rS10 &= \\
&+ Sc \\
&+ Ss S10 \overline{S11} \overline{S12} \overline{S13} \\
(64) &+ Mu \overline{C9} (\overline{M10} Ap)
\end{aligned}$$

$$\begin{aligned}
sS11 &= \\
&+ C10 Sxc \\
&+ P11 Sxp \\
&+ N11 Sxn \\
&+ Ss \overline{S11} \overline{S12} \overline{S13} \\
(64) &+ Mu C10 M11 (Ap + \overline{F3})
\end{aligned}$$

$$\begin{aligned}
rS11 &= \\
&+ Sc \\
&+ Ss S11 \overline{S12} \overline{S13} \\
(64) &+ Mu \overline{C10} (\overline{M11} Ap)
\end{aligned}$$

$$\begin{aligned}
sS12 &= \\
&+ C11 Sxc \\
&+ P12 Sxp \\
&+ N12 Sxn \\
&+ Ss \overline{S12 S13} \\
(64) &+ Mu C11 M12 (Ap + \overline{F3})
\end{aligned}$$

$$\begin{aligned}
rS12 &= \\
&+ Sc \\
&+ Ss S12 \overline{S13} \\
(64) &+ Mu \overline{C11 (M12 Ap)}
\end{aligned}$$

$$\begin{aligned}
sS13 &= \\
&+ C12 Sxc \\
&+ P13 Sxp \\
&+ N13 Sxn \\
&+ Ss \overline{S13} \\
(64) &+ Mu C12 M13 (Ap + \overline{F3})
\end{aligned}$$

$$\begin{aligned}
rS13 &= \\
&+ Sc \\
&+ Ss S13 \\
(64) &+ Mu \overline{C12 (M13 Ap)}
\end{aligned}$$

$$\begin{aligned}
sS14 &= \\
&+ C13 Sxc \\
&+ P14 Sxp \\
&+ N14 Sxn \\
(64) &+ Mu C13 M14 (Ap + \overline{F3})
\end{aligned}$$

$$\begin{aligned}
rS14 &= \\
&+ Sc \\
(64) &+ Mu \overline{C13 (M14 Ap)}
\end{aligned}$$

SCOPE SIGNALS

	<u>Color</u>
An	Red
Bn	Yellow
C23	White
Xn	Natural
Ecw	Black
Ts	Yellow
Ø0	Orange
Tp End $\overline{Sk}$ Go M0	Red ←
T0	Brown
Gnd	Black

Note: This signal provides a scope "sync" on any instruction executed which has a "1" in bit position zero.

Skip Flip-Flop

sSk	=
(60)	+ Ø4 01 $\overline{05}$ $\overline{06}$ Tp C0
(52, 50, 70, 72)	+ 01 03 $\overline{04}$ Ø6 $\overline{06}$ T24
(73)	+ 01 03 $\overline{04}$ Ø6 05 06 02 $\overline{Tp}$ $\overline{T24}$ $\overline{T0}$ An $\overline{C23}$
(73)	+ 01 03 $\overline{04}$ Ø6 05 06 T0 C23 $\overline{An}$
(53)	+ 01 03 $\overline{04}$ Ø6 05 06 T0 C23 $\overline{02}$
(40)	+ Ø5 01 $\overline{04}$ T0 Sks
(66, 67)	+ $\overline{F1}$ F3 $\overline{Ts}$ 05 $\overline{S9}$ $\overline{S10}$ $\overline{S11}$ $\overline{S12}$ $\overline{S13}$ $\overline{S14}$ T0 $\overline{Ts}$
(67)	+ $\overline{F1}$ F3 05 06 $\overline{Ts}$ S2 T0 Aw $\overline{An}$
(67)	+ $\overline{F1}$ F3 05 06 $\overline{Ts}$ S2 T0 $\overline{Aw}$ An
(65, 66, 67)	+ Ø3 T0 S8
(41)	+ Xnr $\overline{02}$ $\overline{04}$ $\overline{Xn}$ $\overline{Tp}$ $\overline{T24}$ $\overline{T0}$
(74)	+ Xnr T14 01 02 03 04 Ø6 Xw
(64)	+ $\overline{05}$ $\overline{06}$ Ø3 T24

Skip Flip-Flop (cont.)

$$\begin{aligned}
 rSk &= \\
 (72) &+ 01\ 03\ \overline{04}\ \overline{06}\ 05\ \overline{06}\ \overline{Tp}\ \overline{T24}\ C23\ An\ 02 \\
 (52) &+ 01\ 03\ \overline{04}\ \overline{06}\ 05\ \overline{06}\ \overline{Tp}\ \overline{T24}\ C23\ Bn\ \overline{02} \\
 (50) &+ 01\ 03\ \overline{04}\ \overline{06}\ \overline{05}\ \overline{06}\ \overline{Tp}\ \overline{T24}\ \overline{02}\ An\ \overline{C23} \\
 (50) &+ 01\ 03\ \overline{04}\ \overline{06}\ \overline{05}\ \overline{06}\ \overline{Tp}\ \overline{T24}\ \overline{02}\ \overline{An}\ C23 \\
 (70) &+ 01\ 03\ \overline{04}\ \overline{06}\ \overline{05}\ \overline{06}\ \overline{Tp}\ \overline{T24}\ Bn\ An\ \overline{C23} \\
 (70) &+ 01\ 03\ \overline{04}\ \overline{06}\ \overline{05}\ \overline{06}\ \overline{Tp}\ \overline{T24}\ Bn\ \overline{An}\ C23 \\
 (73) &+ 01\ 03\ \overline{04}\ \overline{06}\ 05\ 06\ \overline{An}\ C23\ \overline{Tp}\ \overline{T24}\ \overline{T0} \\
 (73) &+ 01\ 03\ \overline{04}\ \overline{06}\ 05\ 06\ An\ \overline{C23}\ T0 \\
 &+ \overline{00}\ T0 \\
 &+ \overline{07}\ T0 \\
 (74) &+ \overline{07}\ 01\ 02\ 03\ 04\ Xn\ \overline{T24} \\
 &+ \textcircled{St}
 \end{aligned}$$

SKS

Skip if:

$$\begin{aligned} \text{Sks} &= C10 \overline{C11} C13 \overline{Y9 Y10 Y11 Y12 Y13 Y14} \\ &+ C10 \overline{C11} C14 \overline{W9 W10 W11 W12 W13 W14} \\ &+ C10 \overline{C11} C15 \text{(Kb1)} \\ &+ C10 \overline{C11} C16 \text{(Kb2)} \\ &+ C10 \overline{C11} C17 \text{(Kb3)} \\ &+ C10 \overline{C11} C18 \text{(Kb4)} \\ &+ C10 \overline{C11} C19 \text{(Ye)} \\ &+ C10 \overline{C11} C20 \overline{We} \\ &+ C10 \overline{C11} C21 (En + \text{(En)}) \\ &+ C10 \overline{C11} C22 \overline{En} \\ &+ C10 \overline{C11} C23 \overline{Of} \\ &+ \overline{C10} C11 \text{Sio} \\ &+ C10 C11 \text{Ssc} \end{aligned}$$

Sio = Inverter fed externally

Ssc = Inverter fed externally

### Buffer Select Flip-Flop

$$sWp = (\overline{Go} + Tsw) \overline{Tsy} \overline{Tsm} Tp$$
$$rWp = (Go \overline{Tsw} + Tsy) \overline{Tsm} Tp + Kf$$

(use inverters to form  $\overline{Tsw}$  and  $\overline{Tsy}$ )

### Time-Share Flip-Flop

$$sTs = (Tsw + Tsy) Tp$$
$$rTs = \overline{Tsw} \overline{Tsy} Tp \overline{Tsm} Kf$$

### Time-Share Memory

$$sTsm = Ts T10 \overline{Tsm}$$
$$rTsm = \overline{Tsm} + T10 Tsm$$

$$Wx = \overline{01} \overline{03} \overline{04} \overline{05} \overline{06} F1 \overline{F3} \overline{Tsm} + Wp Ts$$
$$Yx = \overline{01} \overline{03} \overline{04} \overline{05} \overline{06} F1 \overline{F3} \overline{Tsm} + \overline{Wp} Ts$$



## X REGISTER

Xnr =

(71) + 01 03  $\overline{04}$   $\overline{06}$  02  $\overline{05}$  06

(41) +  $\overline{00}$   $\overline{1a}$   $\overline{02}$   $\overline{03}$  01  $\overline{05}$

(46) +  $\overline{02}$   $\overline{03}$  04  $\overline{T_s}$  Ix

(46) +  $\overline{02}$   $\overline{03}$  04  $\overline{T_s}$  C19

(46) +  $\overline{02}$   $\overline{03}$  04  $\overline{T_s}$  C15

(67) +  $\overline{03}$  05 06 S2

+ Ex D1 D2

+ Ex  $\textcircled{K_x}$

(54-57) + 01  $\overline{02}$  03 04  $\overline{06}$   $\overline{Q1}$   $\overline{Q2}$   $\overline{Q3}$

(77) + 01 02 03 04 05 06  $\overline{1a}$   $\overline{00}$  Q2

+  $\textcircled{K_f}$  (T21 + T22)

(74) + 01 02 03 04  $\overline{05}$   $\overline{06}$  F1  $\overline{T_s}$

$$\begin{aligned}
sXw &= \\
&+ \overline{Xnr} Xn \\
(71) &+ Xnr \ 01 \ 03 \ \overline{04} \ \emptyset 6 \ C23 \\
(41) &+ Xnr \ \overline{02} \ \overline{04} \ (\overline{Xn} \ \overline{Sk} + Xn \ Sk) \\
(46) &+ \overline{02} \ \overline{03} \ 04 \ \overline{Ts} \ C19 \ Bn \\
(46) &+ \overline{02} \ \overline{03} \ 04 \ \overline{Ts} \ Ix \ Xw \ \overline{T23} \\
(46) &+ \overline{02} \ \overline{03} \ 04 \ \overline{Ts} \ C15 \ An \\
(67) &+ Xnr \ \emptyset 3 \ \overline{Ix} \ Xn \\
(67) &+ Xnr \ \emptyset 3 \ Ix \ \overline{Xn} \\
&+ Xnr \ Ex \ C23 \\
(54-57) &+ Xnr \ \overline{02} \ 03 \ T0 \ (Xz \ Cz + Yz \ Cz + Xz \ Yz + Cz \ Ap + Xz \ \overline{Ap} \ F3 \\
&+ Yz \ \overline{Ap} \ F3) \\
(54-57) &+ Xnr \ \overline{02} \ 03 \ Ix \ T1 \\
&+ (Kf) \ \overline{T21} \ \overline{T22} \\
(74, 77) &+ Xnr \ \overline{F3} \ 01 \ 02 \ 03 \ 04 \ Add \\
(74) &+ Xnr \ F3 \ 01 \ 02 \ 03 \ 04 \ (\overline{Xn} \ \overline{Sk} + Xn \ Sk)
\end{aligned}$$

$$\begin{aligned}
& Xz &= & Xn \text{ lx } \overline{F1} \overline{F3} \overline{T_s} \\
(54-57) & &+ & An \overline{02} 03 04 \overline{06} \\
(63) & &+ & An \overline{04} 01 05 \\
(65) & &+ & An F3 06 \\
(74) & &+ & Bn \overline{06} 01 02 03 04
\end{aligned}$$

$$\begin{aligned}
& Yz &= & \\
& &+ & C23 \overline{F1} \overline{F3} \\
(65) & &+ & F3 S3 C23 \\
(+) & &+ & F1 C23 06 \\
(-) & &+ & F1 \overline{C23} \overline{06}
\end{aligned}$$

---

$$\text{Add} \quad = (Xz \overline{Yz} \overline{Cz} + \overline{Xz} Yz \overline{Cz} + \overline{Xz} \overline{Yz} Cz + Xz Yz Cz)$$

---

$$\text{Add} \quad = (Xz Yz \overline{Cz} + Xz \overline{Yz} Cz + \overline{Xz} Yz Cz + \overline{Xz} \overline{Yz} \overline{Cz})$$

Priority Interrupt (External)

$$sIs1 = (T22 - T17) \textcircled{11}$$

$$rIs1 = Ip1 \underline{Ib} + \overline{St} [dc]$$

$$sIp1 = Is1 \underline{Ie}$$

$$rIp1 = Ip1 \underline{Ib} + \overline{St} [dc]$$

$$sIs2 = (T22 - T17) \textcircled{12}$$

$$rIs2 = \overline{Ip1} Ip2 \underline{Ib} + \overline{St} [dc]$$

$$sIp2 = \overline{Is1} Is2 \underline{Ie}$$

$$rIp2 = \overline{Ip1} Ip2 \underline{Ib} + \overline{St} [dc]$$

$$\textcircled{Ir} = Is1 \overline{Ip1} \\ + \overline{Is1} Is2 \overline{Ip2} \\ + \overline{Is1} \overline{Is2} Is3 \overline{Ip3} + - - - \\ + \overline{Is1} \overline{Is2} \overline{Is3} Is4 \overline{Ip4}$$

$$sIs3 = (T22 - T17) \textcircled{13}$$

$$rIs3 = (\overline{Ip1} \overline{Ip2}) Ip3 \underline{Ib} + \overline{St} [dc]$$

$$sIp3 = (\overline{Is1} \overline{Is2}) Is3 \underline{Ie}$$

$$rIp3 = (\overline{Ip1} \overline{Ip2}) Ip3 \underline{Ib} + \overline{St} [dc]$$

$$sIs4 = (T22 - T17) \textcircled{14}$$

$$rIs4 = (\overline{Ip1} \overline{Ip2}) \overline{Ip3} Ip4 \underline{Ib} + \overline{St} [dc]$$

$$sIp4 = (\overline{Is1} \overline{Is2}) \overline{Is3} Is4 \underline{Ie}$$

$$rIp4 = (\overline{Ip1} \overline{Ip2}) \overline{Ip3} Ip4 \underline{Ib} + \overline{St} [dc]$$

SECTION II

W BUFFER AND INPUT/OUTPUT OPERATIONS

## INTRODUCTION

This section describes the theory of operation of the W Buffer and Input/Output Equipment. It is intended for engineering, maintenance and training use. For proper use of this document, the reader should be familiar with the SDS Reference Manual for this computer.

The operation of the optional Y Buffer is almost identical to that of the W Buffer.

## GENERAL W BUFFER OPERATION

The Input/Output or W Buffer contains a full-word register, a six-bit character register, six-bit unit address register and the associated control circuitry needed to transfer full words to and from memory. The W Buffer communicates directly with external devices using a 6-bit character. Parity detection and generation is automatically performed in the buffer, but is not part of the computer word.

Input and output operations using the buffer are basically performed in the following manner. An EOM instruction sets the input or output address to designate the particular I/O device, input or output status, and the character count (number of characters per word). WIM and MIW instructions are then used to transfer information between memory (via the C register) and the Word Assembly Register (WAR). When the WAR has been filled on input (or emptied on output), an interrupt can occur to cause the computer to unload (WIM) or fill (MIW) the WAR unless the interrupt has been disabled; in case the interrupt has been disabled, the WIM or MIW instruction will be executed prior to need and held until the buffer is ready for execution.

When an EOM0XXXX instruction to start an input or output process is executed, the buffer unit address register and character counter is set up from the C register. The registers are first cleared by  $W_c$ ,

$$W_c = B_{uc} \overline{CT7} (T_{22} - T_{17}) + - - -$$

$$B_{uc} = 05 \ 01 \ 05 \ \overline{CT0} \ \overline{CT1}$$

and then set from the C register by  $W_s$ ,

$$W_s = B_{uc} \overline{CT7} (T_5 - T_0)$$

where  $\overline{CT7}$  designates the W Buffer.

$sW_{14} = W_s C_{23}$ $rW_{14} = W_c$ $\vdots$ $sW_{10} = W_s C_{19}$ $rW_{10} = W_c$	}	Unit address code																		
$sW_9 = W_s C_{18}$ $rW_9 = W_c$	}	$W_9 = 1$ for Output $W_9 = 0$ for Input																		
$sW_8 = W_s C_{16} + - - -$ $rW_8 = W_c (T_{22} - T_{17}) + - - -$ $sW_7 = W_s C_{15} + - - -$ $rW_7 = W_c (T_{22} - T_{17}) + - - -$	}	Character count	<table style="border-collapse: collapse;"> <tr> <td style="padding-right: 10px;"><math>W_7</math></td> <td style="padding-right: 10px;"><math>W_8</math></td> <td style="padding-right: 10px;">Character/word</td> </tr> <tr> <td style="text-align: center;">1</td> <td style="text-align: center;">1</td> <td style="text-align: center;">4</td> </tr> <tr> <td style="text-align: center;">1</td> <td style="text-align: center;">0</td> <td style="text-align: center;">3</td> </tr> <tr> <td style="text-align: center;">0</td> <td style="text-align: center;">1</td> <td style="text-align: center;">2</td> </tr> <tr> <td style="text-align: center;">0</td> <td style="text-align: center;">0</td> <td style="text-align: center;">1</td> </tr> </table>	$W_7$	$W_8$	Character/word	1	1	4	1	0	3	0	1	2	0	0	1		
$W_7$	$W_8$	Character/word																		
1	1	4																		
1	0	3																		
0	1	2																		
0	0	1																		

Refer to Drawing 19.

At the end of the start EOM0XXXX instruction, W4 is set on for two pulse times to gate the storing of the character count into the WAR.

$$\begin{aligned}
 sW4 &= Ws T0 + - - - \\
 rW4 &= W4 T24 + - - - \\
 sWw &= W4 Tp W8 + W4 T24 W7 \\
 &+ - - - + (Tp + T24) \overline{W4} Wn + \overline{W4} \overline{Wx} Wn
 \end{aligned}$$

This allows W8 and W7 to act as a character counter during input or output and be reloaded from the WAR each time that a completed input word is stored from the WAR, or a new output word is loaded into the WAR by a Wx signal.

$$\begin{aligned}
 sW8 &= - - - + Wx T24 Ww + - - - \\
 sW7 &= - - - + Wx T24 \overline{W4} Wn + - - -
 \end{aligned}$$

Both for shifting an input character from the single character register into the WAR, and for shifting an output character from the WAR into the SCR, W4 is set for (T23 - T0) of one machine cycle to gate a one-character precession in the WAR, by causing the data in the WAR to recirculate through the SCR.

$$\begin{aligned}
 sR1 &= W4 Wn \overline{Wx} \overline{Tp} \overline{T24} + - - - \\
 rR1 &= W4 \overline{Wn} \overline{Wx} + - - - \\
 sR2 &= W4 R1 + - - - \\
 rR2 &= W4 \overline{R1} + - - - \\
 &| \\
 &| \\
 &| \\
 sR6 &= W4 R5 + - - - \\
 rR6 &= W4 \overline{R5} + - - - \\
 sWw &= W4 R6 + - - - + \overline{W4} Wn \overline{Wx}
 \end{aligned}$$

Wf is set when a WIM or MIW instruction is executed. Wf then allows precessions of the WAR until the character counter (W7 W8) indicates that the last character is being precessed and Wf is reset.

The signaling to the computer for a WIM or MIW instruction is conditioned by  $\overline{Wf}$  ( - - - - ), indicating that the WAR is full or empty.

$$\begin{aligned}
 sWf &= Wx (T5 - T0) \overline{W4} \\
 rWf &= \overline{W8} \overline{W7} W4 (T22 - T17)
 \end{aligned}$$

The character count at T24 and Tp in Wn is not altered by this precession. At the end of each precession of the WAR, the character count in W8 and W7 is decremented until W8 W7 = 00.



C REGISTER

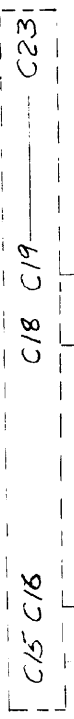

FULL OR EMPTY

M1W

W1M

EOM

NO OF CHAR.

W4

W7 W8

WORD ASSEMBLY REG. Ww

LOAD

STORE

W4

W9

W10

W14

DECREMENT

PRECES

PRECES

CLOCK DETECTOR

W16 W5

PRECES DETECTOR

CLOCK

W4

W10

W14

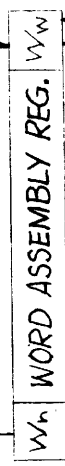

IN PUTS OR OUTPUTS

UNIT ADDRESS

UNIT CODE

I/O

IN OR OUT

DESIGNATES UNIT

FIGURE 19  
W BUFFER  
INFORMATION FLOW

$$\begin{aligned}
sW8 &= \text{---} + W7 \overline{W8} W4 T0 + \text{---} \\
rW8 &= \text{---} + W8 W4 T0 \\
rW7 &= \text{---} + W7 \overline{W8} W4 T0
\end{aligned}$$

The setting of W4 is interlocked with W6 and W5 to cause a precession of the WAR after each input or output clock signal, E<sub>cw</sub>. The setting of W4 is also interlocked with Wf to prevent a precession when the WAR is full on input or empty on output. The clock E<sub>cw</sub> is detected by W6 as follows.

$$\begin{aligned}
sW6 &= \overline{W5} E_{cw} (T22 - T17) \\
rW6 &= W5 T0 + Wc
\end{aligned}$$

The precess condition is then detected by W5.

$$\begin{aligned}
sW5 &= \overline{W5} W6 \overline{E_{cw}} T0 + \text{---} \\
rW5 &= W4 T0 + Wc
\end{aligned}$$

The actual precessing is then controlled by W4.

$$\begin{aligned}
sW4 &= \text{---} + W5 Wf T24 + \text{---} \\
rW4 &= \text{---} + W4 T0
\end{aligned}$$

Wh and W0 provide an interlock on interrupt signaling in connection with the stopping of an input or output process, as will be indicated later.

The foregoing discussion applies to both input and output processes. Particular features of the input and output processes are discussed separately in the following material.

### INPUT PROCESS ( $\overline{W9}$ )

After an EOM0XXXX instruction starts an input process, Wf is set to prepare the W Buffer to precess the first input character into the WAR.

$$sWf = \text{---} + Wc \overline{Wh}$$

The S.C.R. is cleared between input clock signals by  $\overline{W9} \overline{W6} \overline{W5} \overline{W4}$  and the input character signals Zw1, Zw2 . . . Zw6 and Zwp, are gated into the character buffer during input clock signals by  $\overline{W9} \overline{W6} \overline{W5}$ .

$$\begin{aligned}
sR1 &= \text{---} + \overline{W9} W6 \overline{W5} Zw1 \\
rR1 &= \text{---} + \overline{W9} \overline{W6} \overline{W5} \overline{W4} + \text{---} \\
&\vdots \\
sR6 &= \text{---} + \overline{W9} W6 \overline{W5} Zw6 \\
rR6 &= \text{---} + \overline{W9} \overline{W6} \overline{W5} \overline{W4} + \text{---} \\
&\vdots \\
sRp &= \overline{W9} W6 \overline{W5} Zwp + \text{---} \\
rRp &= \overline{W9} \overline{W6} \overline{W5} \overline{W4} + \text{---}
\end{aligned}$$

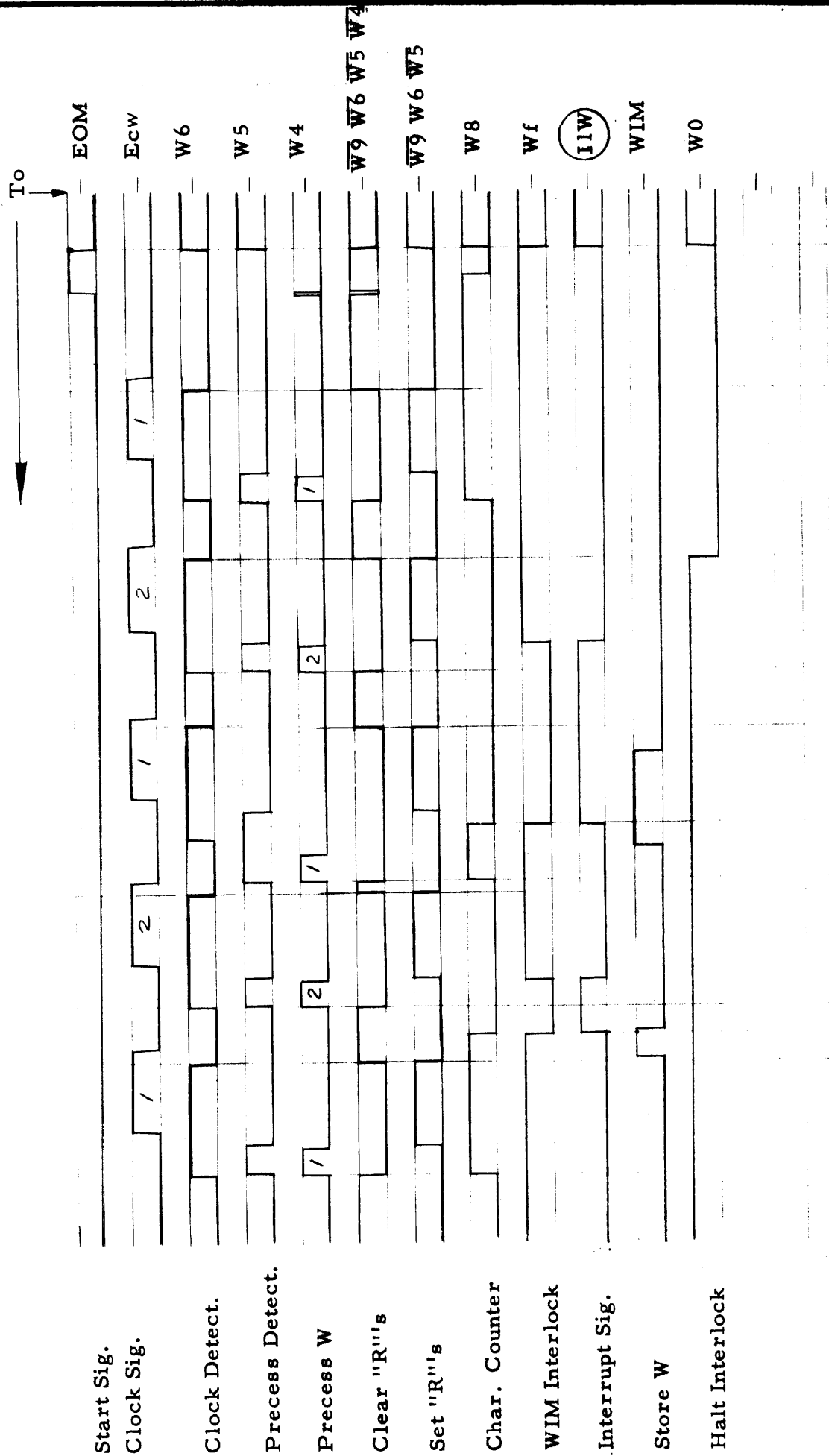

FIGURE 20  
 INPUT TIMING CHART  
 (2 Char. /Word)

The Input Timing Chart indicates the basic flow of the input process. The execution of the first WIM instruction is shown occurring late to illustrate how the S. C. R. accepts and holds one more character after the WAR is full. When a WIM instruction is executed late, the Error Detector flip-flop is set and, if desired, this condition can be tested by an SKS instruction. The Error Detector flip-flop ( $W_e$ ) is reset by each EOM0XXXX instruction.

$$\begin{aligned} sW_e &= W_0 \overline{W_6} W_5 E_{cw} T_p + - - - \\ rW_e &= W_c \overline{W_h} \end{aligned}$$

The Error Detector flip-flop is also set if an input character has an even parity.

The  $R_p$  flip-flop is used to check the character parity as each character is shifted into the WAR.

$$\begin{aligned} sR_p &= - - - + \overline{W_9} W_4 \overline{R_p} W_w (T_{22} - T_{17}) + - - - \\ rR_p &= - - - + \overline{W_9} W_4 R_p W_w (T_{22} - T_{17}) + - - - \\ sW_e &= - - - + \overline{W_9} W_4 \overline{R_p} (T_5 - T_0) + - - - \end{aligned}$$

Each time a WIM instruction is executed, the C and Word Assy registers are interchanged.

$$\begin{aligned} sC_0 &= \overline{O_4} \overline{O_1} \overline{O_4} O_5 \overline{O_6} W_n \\ W_x &= (\overline{O_1} O_3 \overline{O_4} O_5 \overline{O_6} F_1 \overline{F_3}) \overline{T_s} + - - - \\ sW_w &= W_4 R_6 + (\overline{T_{24}} \overline{T_p}) \overline{W_4} W_x C_{23} + - - - + \overline{W_4} W_n \overline{W_x} \\ sR_1 &= W_4 W_n \overline{W_x} + - - - \\ rR_1 &= W_4 \overline{W_n} \overline{W_x} + - - - \\ \vdots & \\ sR_6 &= W_4 R_5 + - - - \\ rR_6 &= W_4 \overline{R_5} + - - - \end{aligned}$$

Synchronizing  $W_6$  and  $W_5$  with  $T_0$  and  $T_{22}-T_{17}$  allows the input clock to be ambiguous for one machine cycle both while going true and while going false. The input clock must be unambiguously true for almost one machine cycle and unambiguously false for at least one machine cycle ( $f_{max} = 62.5 \text{ Kc}$ ). Refer to Figure 21. The input character signals must rise while the clock signal is up and fall before the rise of the next clock signal.

A photo-reader input process is terminated by detecting tape gap following the block of input data. Since the photo-reader must be able to read tape leader until the start of a block, the  $W_0$  flip-flop inhibits the sprocket clock signals until it is set by the first or second character.

$$\begin{aligned} sW_0 &= \overline{W_9} W_6 \overline{W_8} + - - - \\ rW_0 &= W_c + - - - \end{aligned}$$

The input clock signal is derived from the tape characters, and after  $W_0$  is set, by the sprocket signal.

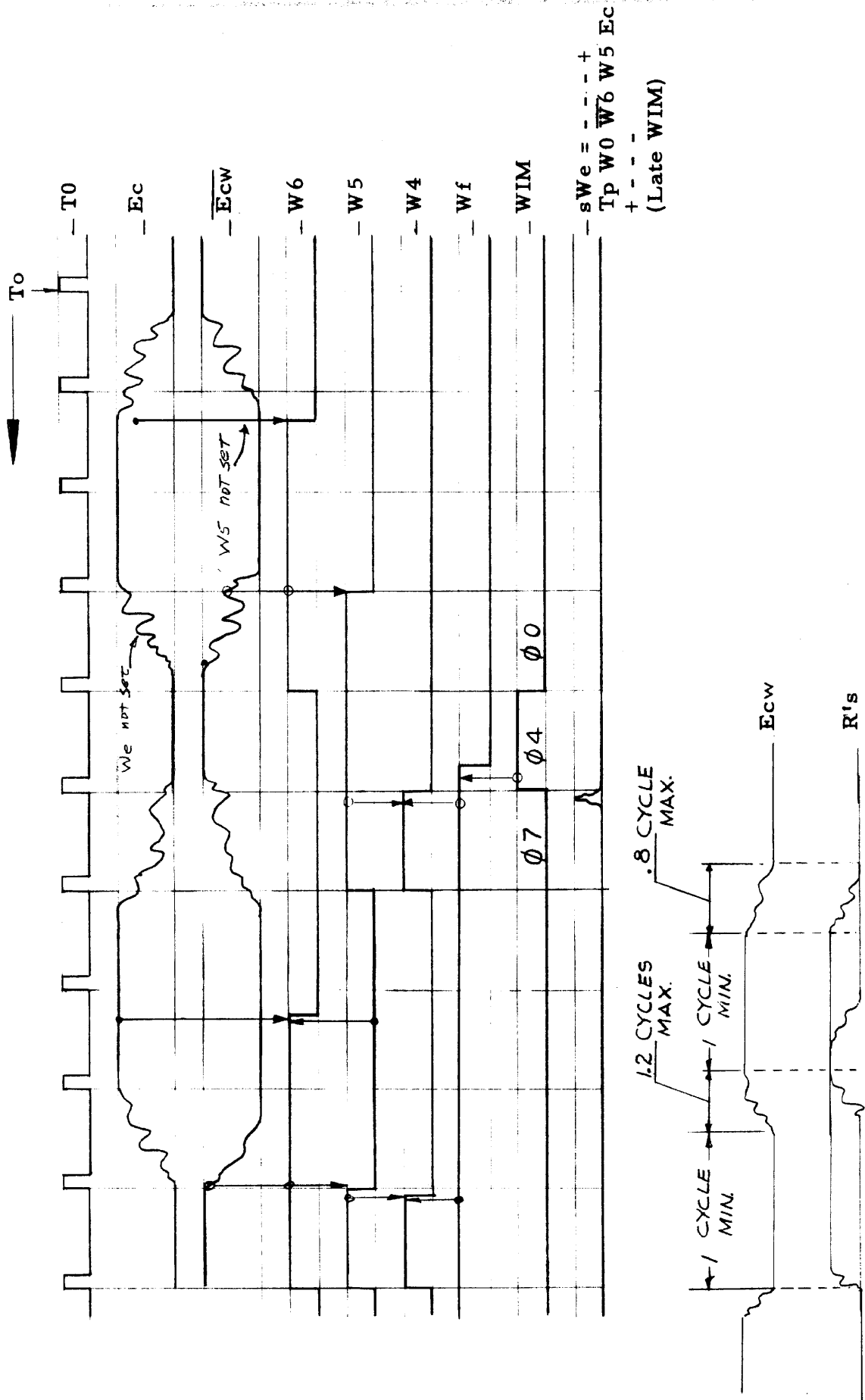

FIGURE 21  
INPUT SIGNAL CHARACTERISTICS

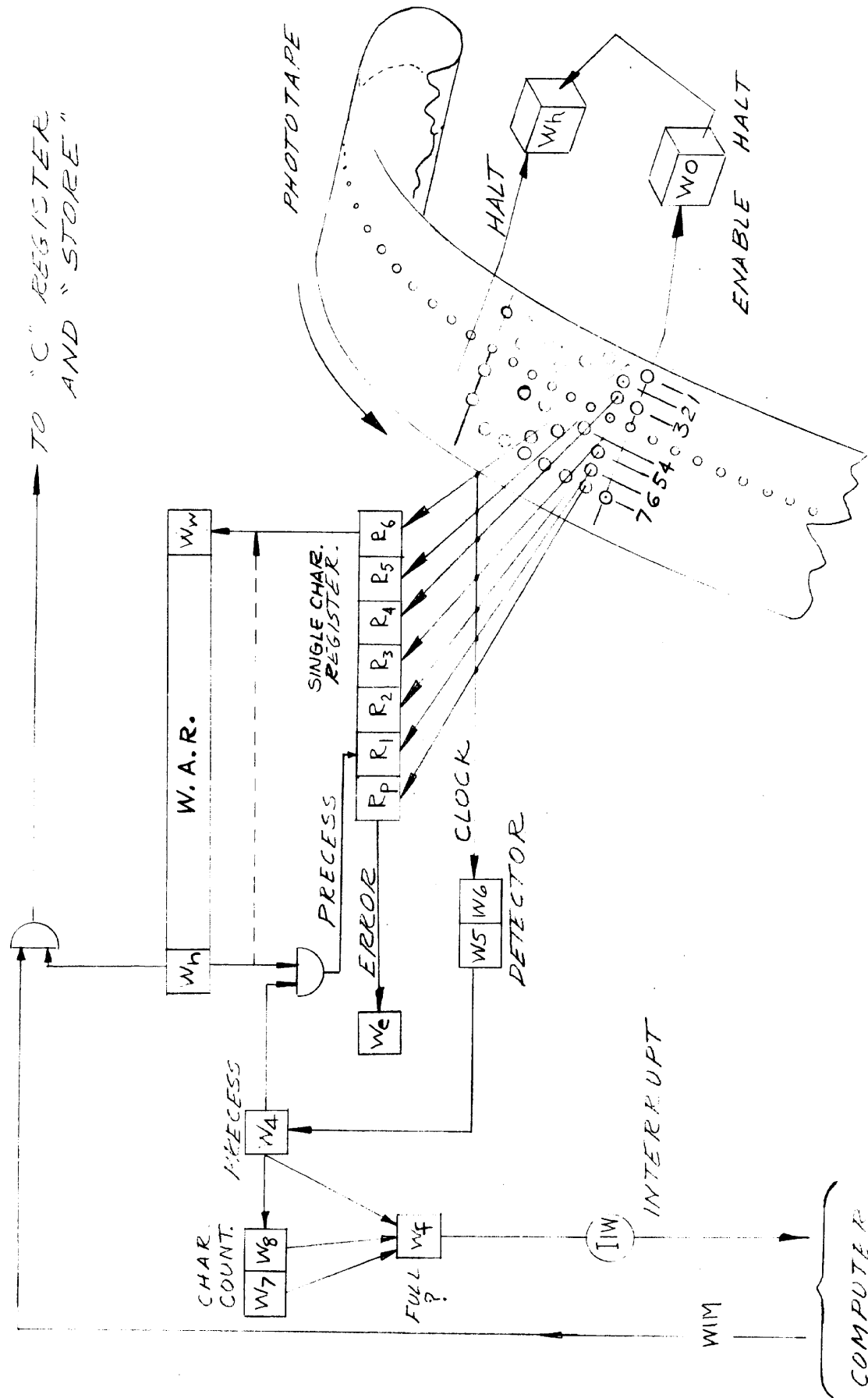

FIGURE 22  
 INFORMATION FLOW DIAGRAM  
 PHOTOTAPE

$$Ecw = (Zw1 + Zw2 + Zw3 + Zw4 + Zw5 + Zw6 + Zwp + W0) Sp Re$$

$$Zw1 = (\text{Ch 6 amplifier}) Re$$

$$Zw2 = (\text{Ch 5 amplifier}) Re$$

$$Zwp = (\text{Ch 7 amplifier}) Re$$

The first, all-zeros character gated into the S.C.R. is detected by the halt detector, Wh, at the same time that W4 is set.

$$sWh = \overline{W9} \overline{W10} \overline{W11} \overline{W12} \overline{W13} (\overline{R1} \overline{R2} \overline{R3} \overline{R4} \overline{R5} \overline{R6} \overline{Rp}) W5 T24$$

+ - - -

$$rWh = Wc$$

$$sW4 = - - - + W5 Wf T24$$

$$rW4 = - - - + W4 T0$$

With Wh set, parity errors are no longer used to set We.

$$sWe = - - - + \overline{W9} W4 \overline{Rp} (T5-T0) \overline{Wh} + - - -$$

W4 is set for successive cycles until the character counter reads 00 when Wf is reset, and the W Buffer is reset.

$$sW4 = - - - + Wh T24$$

$$rW4 = - - - + W4 T0$$

$$sWf = - - - + Wc \overline{Wh}$$

$$rWf = \overline{W8} \overline{W7} W4 (T22-T17) + - - -$$

$$Wc = + - - - Wh \overline{Wf} T0 + - - -$$

The tape reader brake is signaled.

$$\text{reader 1 brake} \leftarrow \overline{W9} \overline{W10} \overline{W11} \overline{W12} \overline{W13} \overline{W14} \overline{Kf}$$

This termination process fills in the final input word with all-zero characters. The Photo-tape Termination Timing Charts show the flow of this termination process. A halt interrupt signal is generated during the  $\overline{Wf} Wh$  cycle to call for a final WIM instruction and to signal the termination of the input process.

$$\textcircled{12w} = \overline{Wf} Wh ( - - - )$$

The final WIM instruction in the Halt subroutine will store the data even though the last input may not have a complete complement of characters. The Magnetic Tape Input Timing Chart shows the flow of this input process. As with photo-reader input, a final WIM instruction is executed after the halt interrupt to store any remaining characters in the WAR. The magnetic tape unit generates a halt signal with a time delay triggered by the tape gap signal and W0. The halt detector is then triggered by this halt signal.

$$sWh = - - - + Whs T24 + - - -$$

The magnetic tape-handler is also stopped directly from the Whs signal.

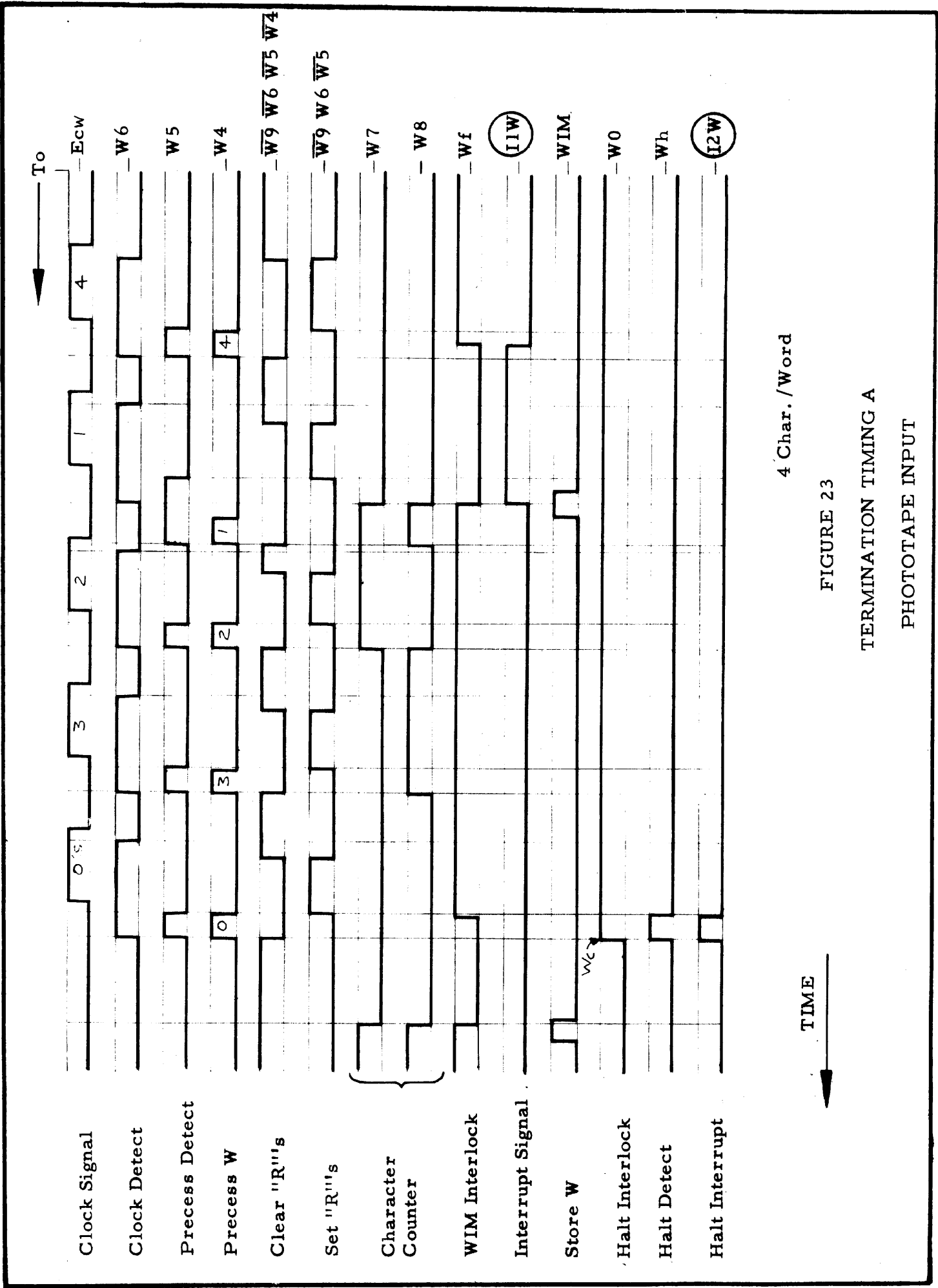

4 Char. / Word

FIGURE 23  
TERMINATION TIMING A  
PHOTOTAPE INPUT

TIME



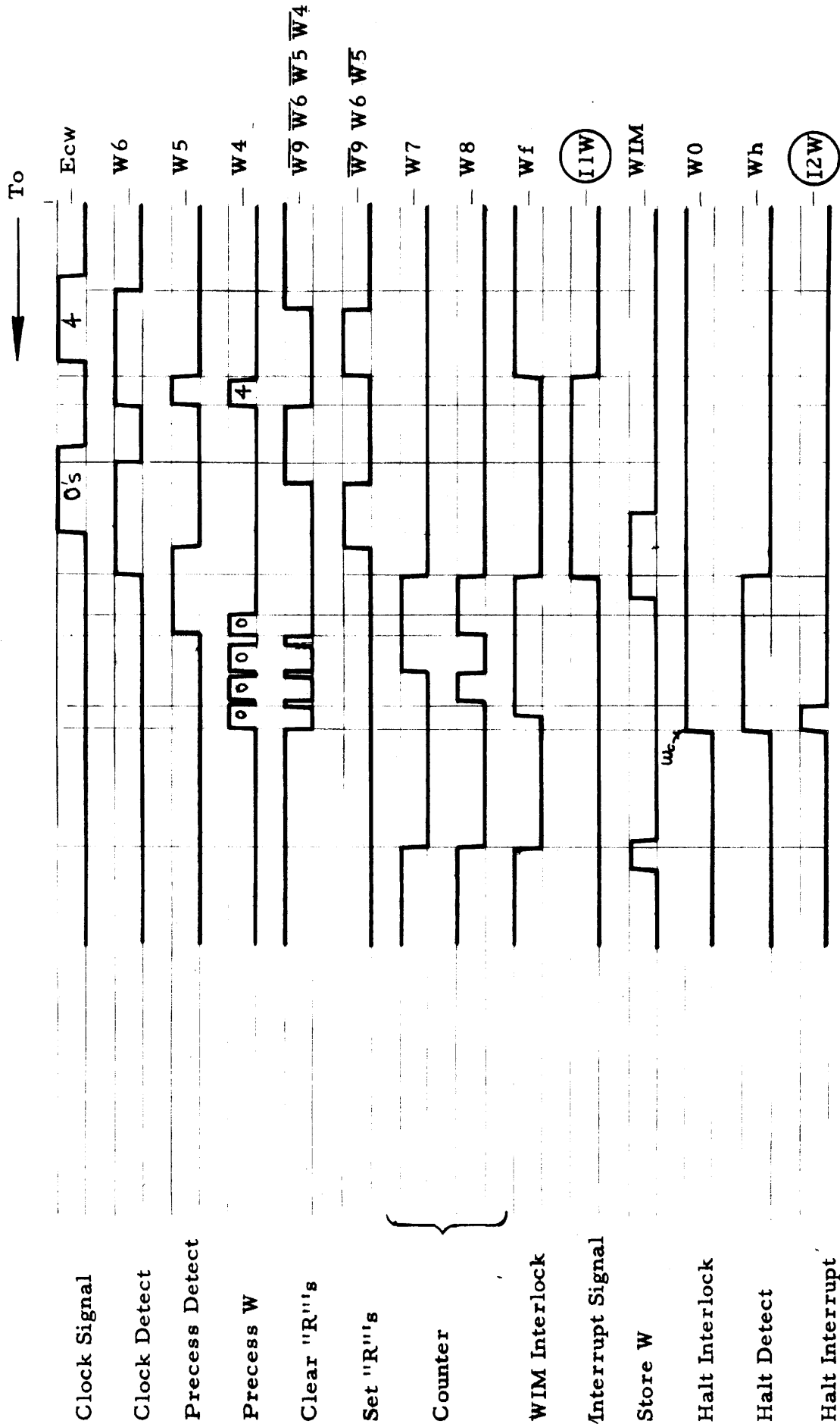

4 Char. / Word

FIGURE 24

TERMINATION TIMING B  
PHOTOTAPE INPUT

TIME

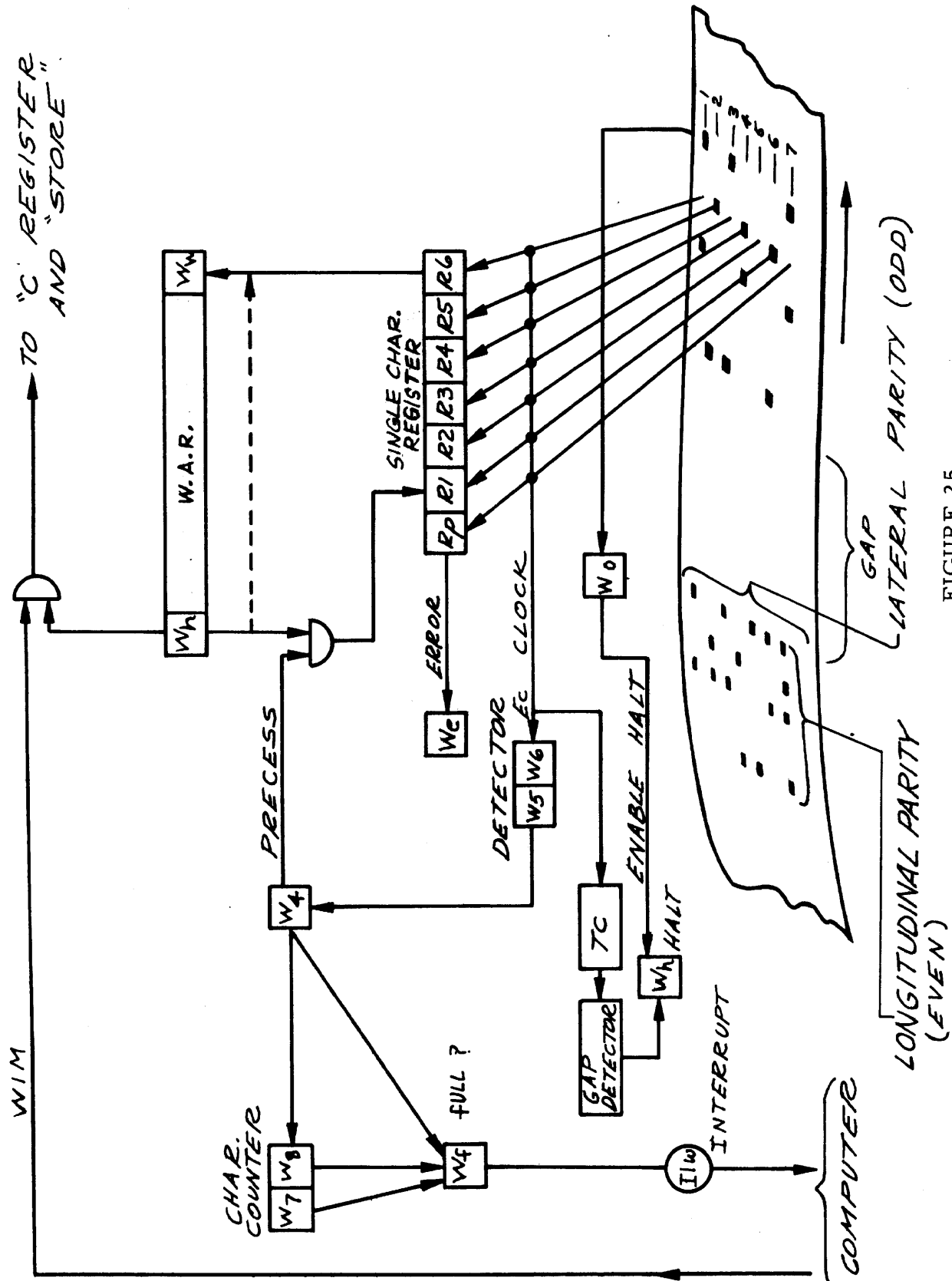
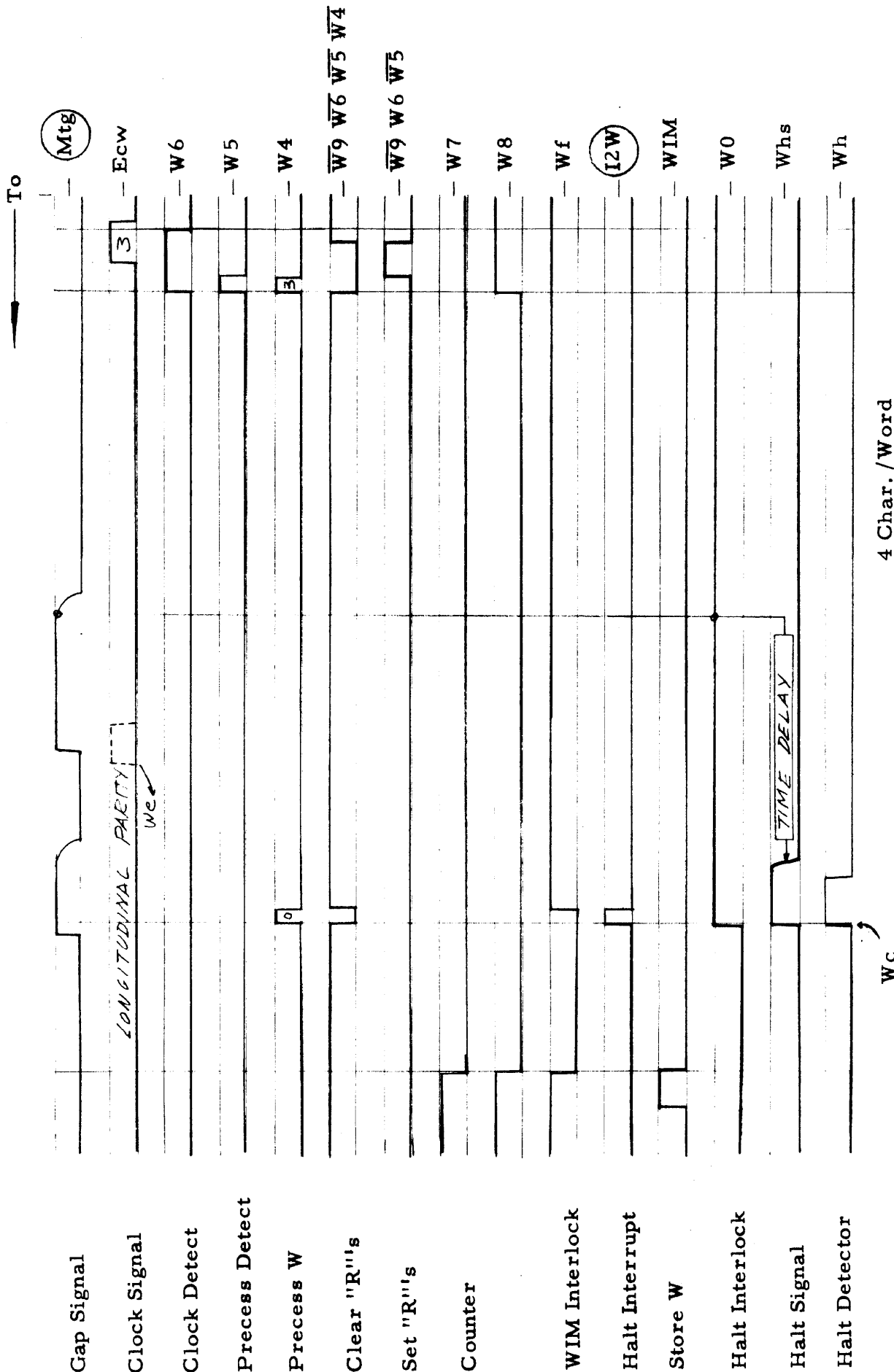

FIGURE 25  
 INFORMATION FLOW DIAGRAM  
 MAGNETIC TAPE





4 Char. / Word

FIGURE 27  
INPUT TERMINATION TIMING  
MAGNETIC TAPE



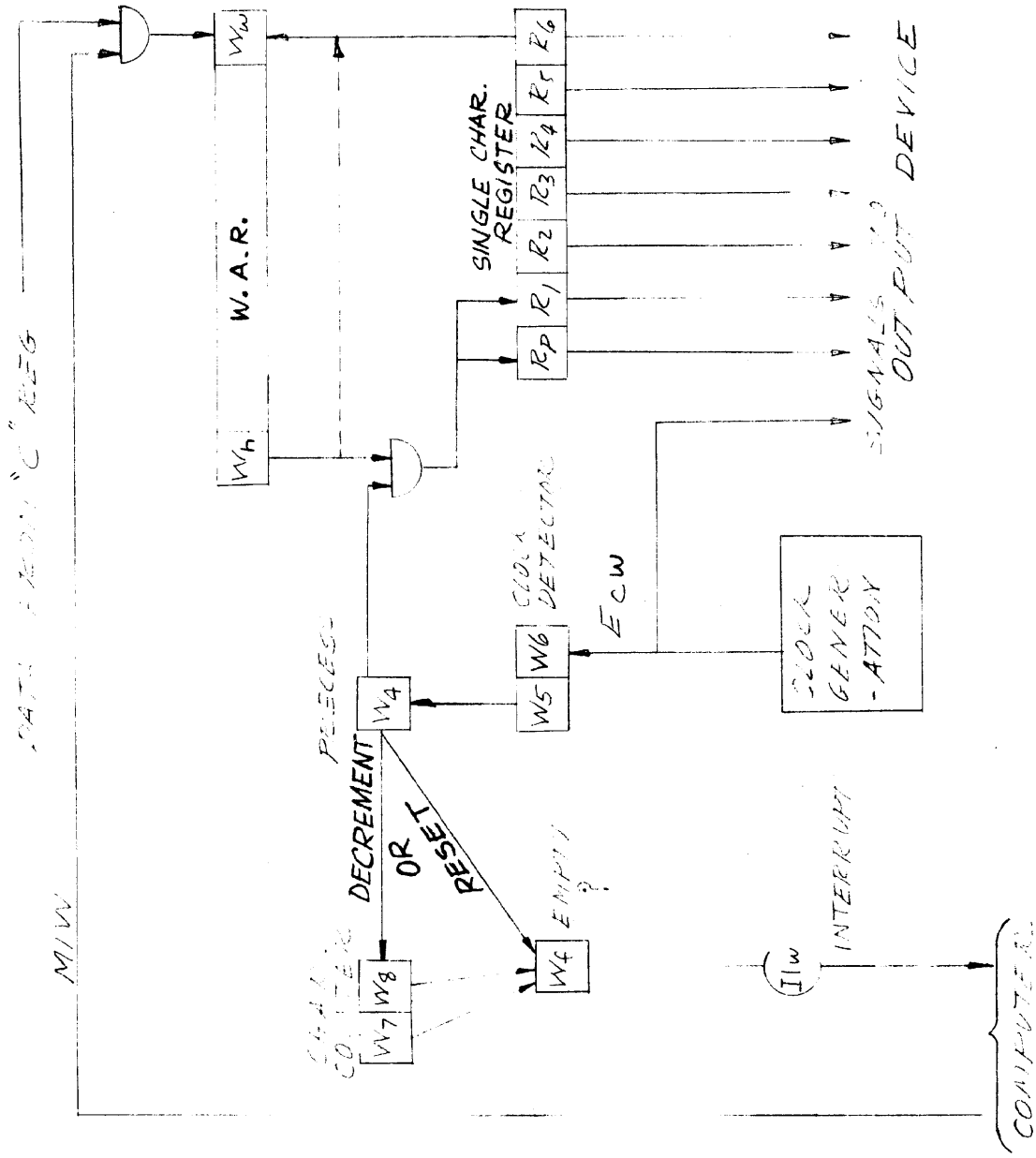

FIGURE 28  
 FLOW DIAGRAM  
 OUTPUT PROCESS

As with input, the SCR is cleared at the start of output by  $\overline{W9} \overline{W6} \overline{W5} \overline{W4}$ . The first output character is, therefore, all zeros for the first clock signal, which is appropriate for a leader, or a gap in tape punching. For some forms of output, such as leaderless punching or typing, the first output character should be in the character buffer before the first clock signal. For this type of output, an EOM02XXX start instruction with a one-bit in C13 is used. This code bit is used to set W5 which then causes the first loading of the WAR to be followed directly by precession of the first output character into the SCR.

$$sW5 = - - - + Ws C13 C18$$

$$rW5 = - - - + W4 T0 + Wc$$

$$sWf = Wx (T5-T0) + - - -$$

$$sW4 = W5 Wf T24 + - - -$$

$$rW4 = W4 T0 + - - -$$

Figure 30, Output Timing Chart 2, illustrates the flow of this process.

On output, E<sub>cw</sub> is generated by various oscillator-type circuitry instead of from the characters. This circuitry is described in a separate publication.

To terminate an output process, the MIW instruction to load the last output word into the WAR is followed by an EOM 14000 instruction to reset W0 (EOM 14100 instruction for the Y Buffer).

$$rW0 = - - - + Ioc C12 \overline{C17} \overline{C20} + - - -$$

Resetting W0 results in the following: Further normal interrupt signals are blocked;

$$\textcircled{I1w} = \overline{Wf} W0 \overline{Wh} (- - - -)$$

further late load W error signals are blocked;

$$sWe = W0 \overline{W6} W5 E_{cw} T_p + - - -$$

and Wf is not set again after it is reset as the last output character is precessed into the SCR.

$$sWf = Wx (T5-T0) + - - -$$

$$rWf = \overline{W8} \overline{W7} W4 (T22-T17) + - - -$$

Preventing the setting of Wf blocks W4 from being set after the last output character is precessed into the SCR.

$$sW4 = W5 Wf T24 + - - -$$

Preventing W4 from being set produces the state,  $\overline{W0} \overline{W4} W5 \overline{W6}$ , after the last output character has been processed by the output clock.

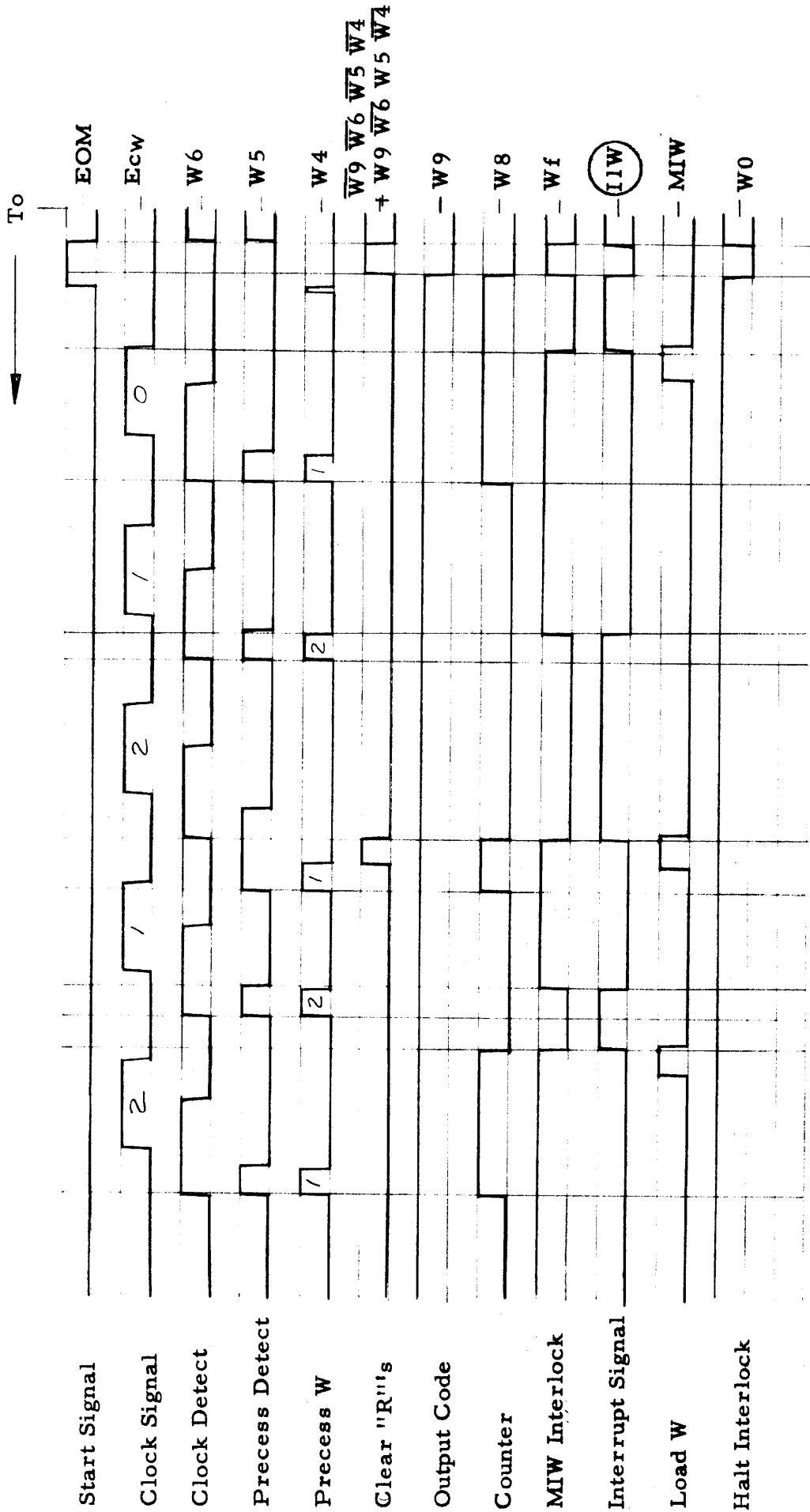

2 Char. / Word starting with Gap or Leader

TIME →

FIGURE 29  
OUTPUT TIMING CHART 1



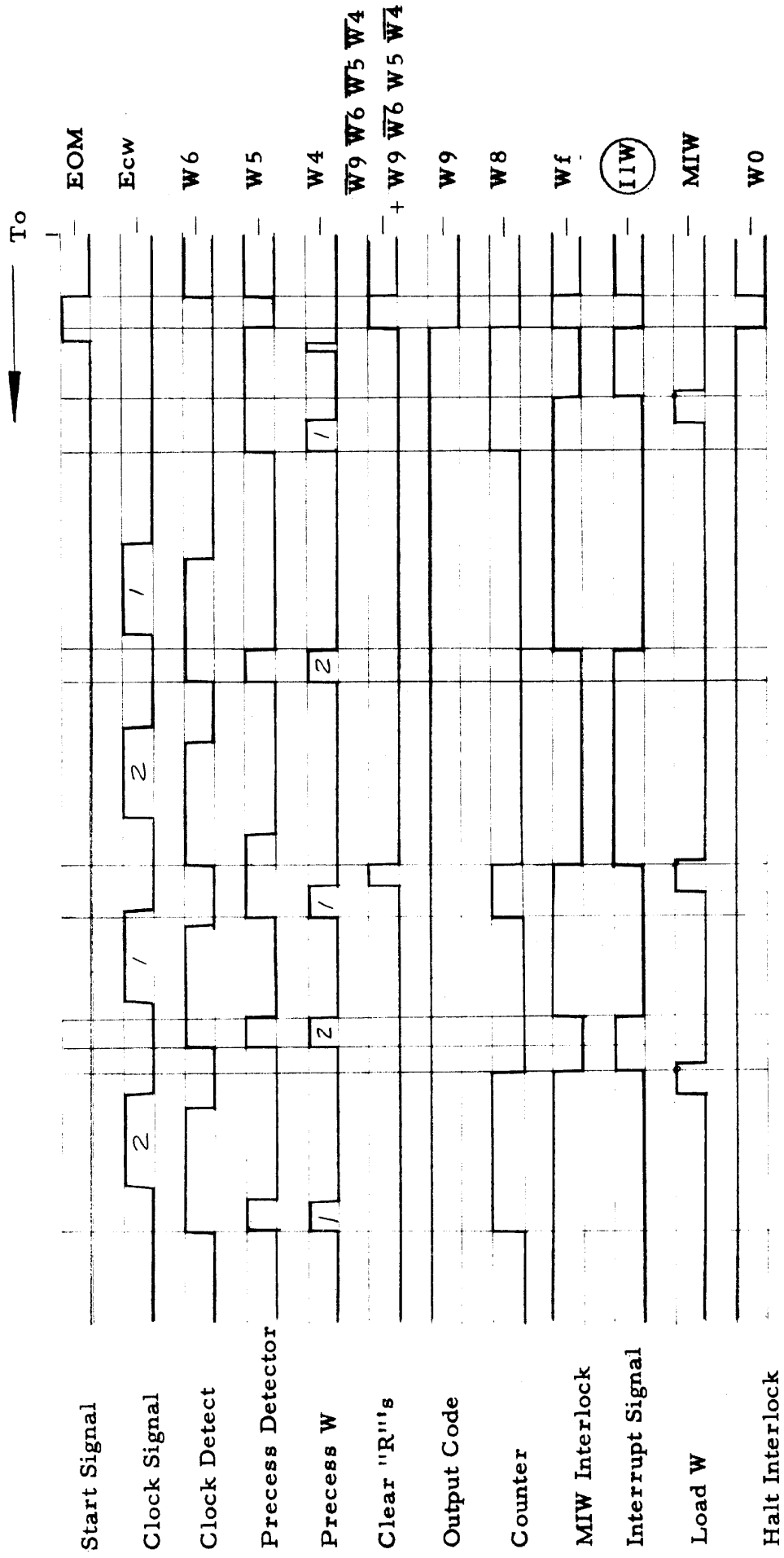

2 Char./Word starting with Leaderless punching or Typing

FIGURE 30  
OUTPUT TIMING CHART 2

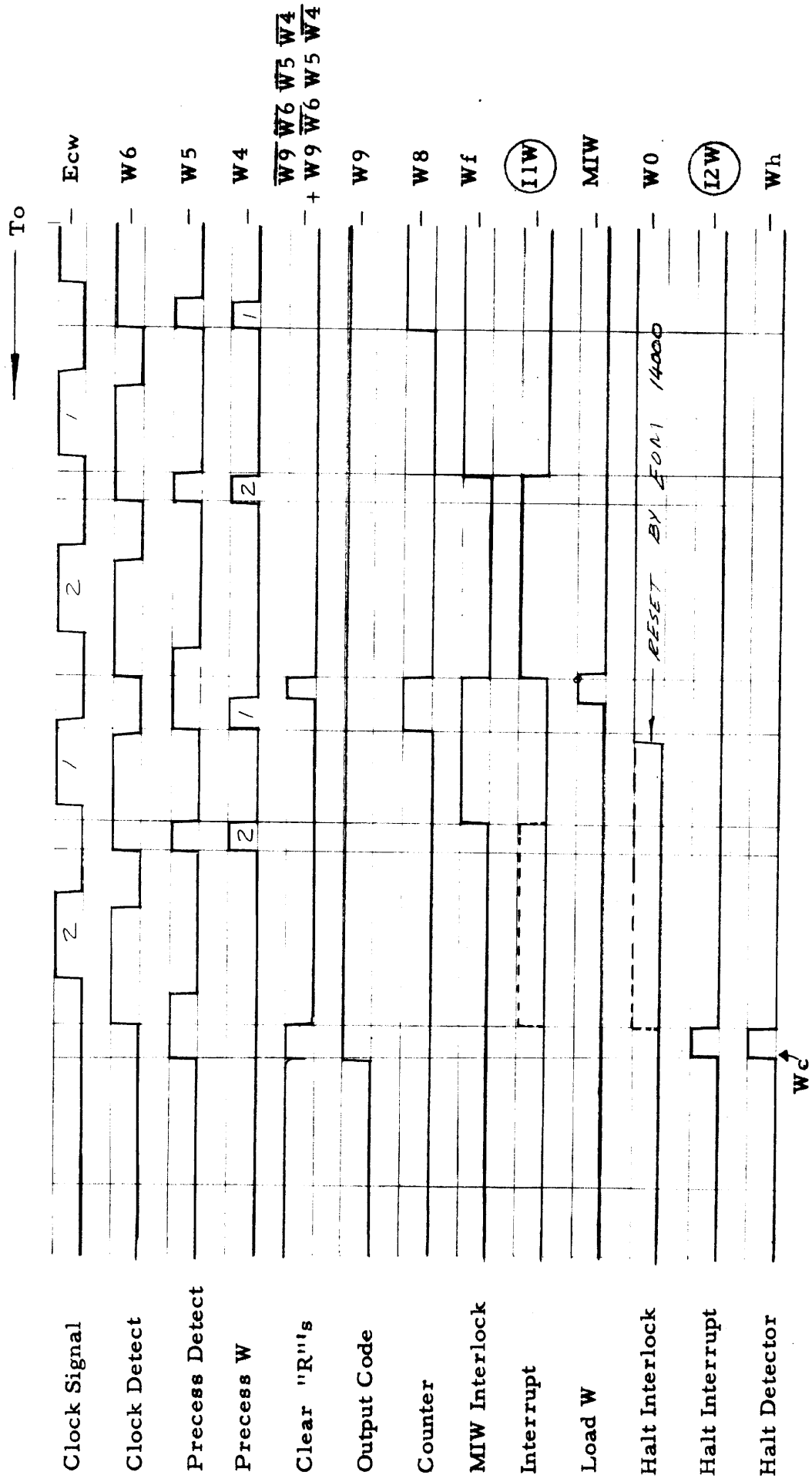

FIGURE 31  
 OUTPUT TERMINATION TIMING  
 (Except Magnetic Tape)



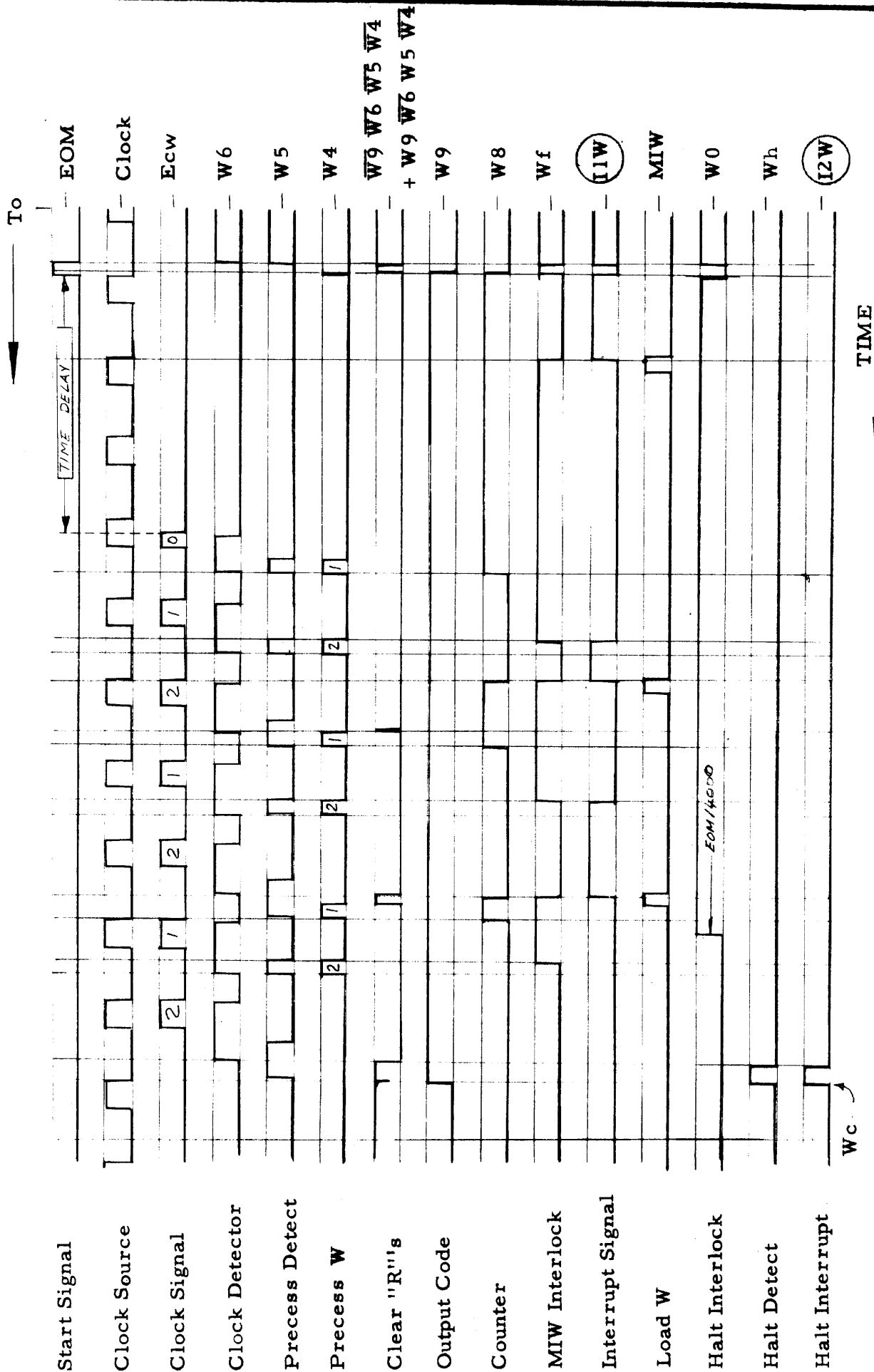

FIGURE 33  
OUTPUT TIMING CHART  
PUNCH

2 Char. / Word

$$\begin{aligned}
sW6 &= \overline{W5} E_{cw} (T22-T17) \\
rW6 &= W5 T0 + Wc \\
sW5 &= \overline{W5} W6 \overline{E_{cw}} T0 + \dots \\
rW5 &= W4 T0 + Wc
\end{aligned}$$

The state,  $\overline{W4} W5 \overline{W6}$ , is used to clear the SCR.

$$\begin{aligned}
rR1 &= \dots + W9 \overline{W4} W5 \overline{W6} \\
&\quad \vdots \qquad \qquad \qquad \vdots \\
rR6 &= \dots + W9 \overline{W4} W5 \overline{W6} \\
rRp &= \dots + W9 \overline{W4} W5 \overline{W6}
\end{aligned}$$

While the state,  $\overline{W0} W5 \overline{W6}$ , is used to set the halt detector for outputs other than magnetic tape outputs,

$$sWh = \dots + W9 \overline{W11} \overline{W0} W5 \overline{W6} T24 + \dots$$

and to signal a magnetic tape unit that the last output character has been processed.

$$\text{Magnetic tape unit} \leftarrow \overline{W0} W5 \overline{W6}$$

A magnetic tape unit, after a suitable delay, provides a halt signal,  $Whs$ , to set  $Wh$ .

$$sWh = \dots + Whs T24 + \dots$$

Regardless of the method of setting  $Wh$  to terminate an output process, the halt interrupt signal is generated in the cycle that  $Wh$  is set.

$$\begin{aligned}
\textcircled{I2w} &= \overline{Wf} Wh (En + \textcircled{En}) \\
rWh &= Wc \\
Wc &= \dots + Wh \overline{Wf} T0 + \dots
\end{aligned}$$

The Output Termination Timing Charts indicate the flow of the output termination processes.

The Punch Output Timing Chart shows the flow of this complete output process. A time delay triggered by the EOM0 XX4X start instruction causes tape leader to be punched first while inhibiting output clock signals. An all-zeros character is also punched for the first output clock signal. After the last output character is processed, a halt interrupt signal is generated.

The Magnetic Tape Output Timing Chart shows the flow of this output process.

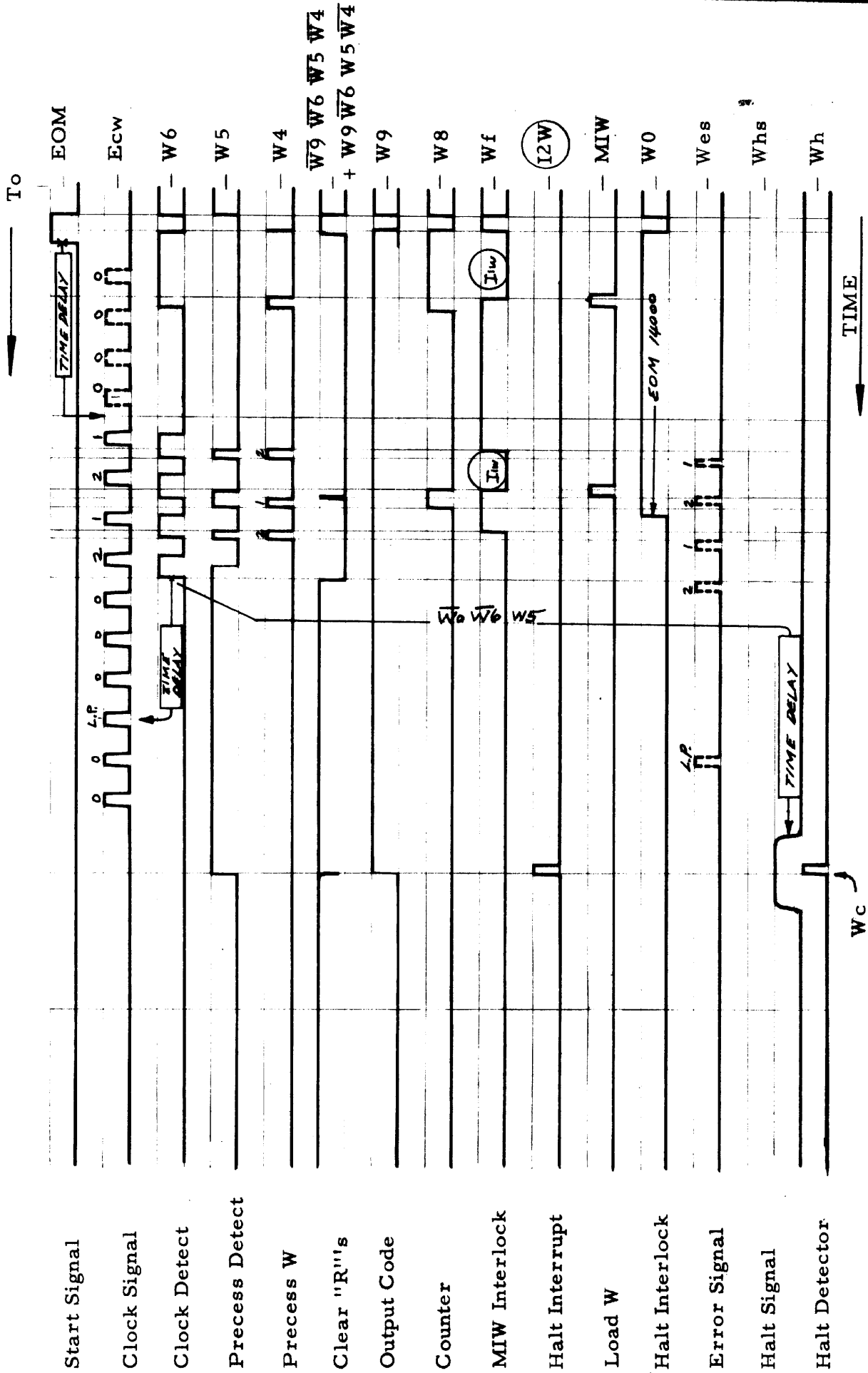

FIGURE 34  
 OUTPUT TIMING CHART  
 MAGNETIC TAPE

2 Char./Word

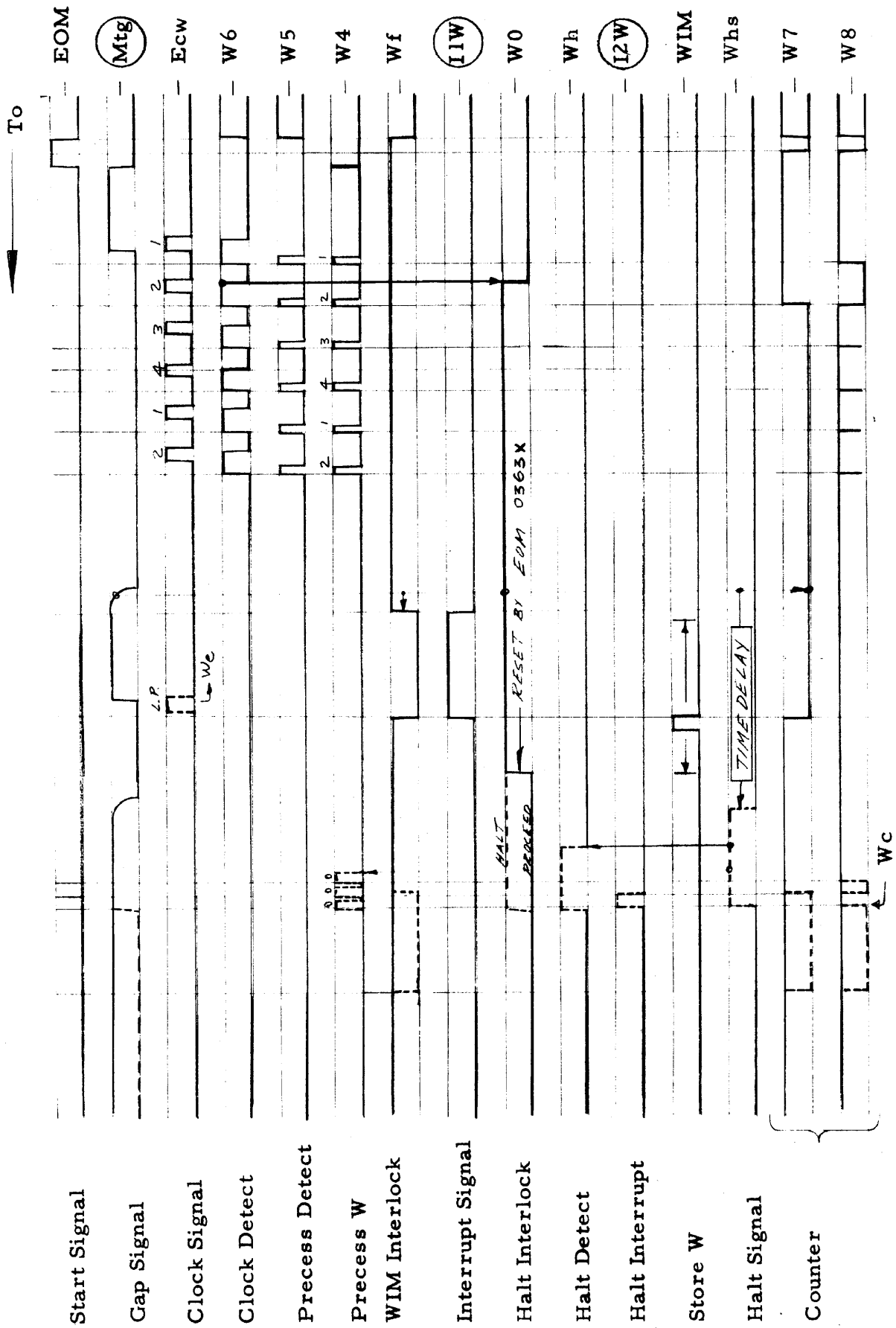

FIGURE 35  
FORWARD SCAN TIMING  
MAGNETIC TAPE

A time delay triggered by the EOM02X5X start instruction causes a tape gap to be recorded first while inhibiting the output clock signals. After the last output character is recorded,  $\overline{W9} \overline{W4} \overline{W5} \overline{W6}$  clears the SCR and  $\overline{W0} \overline{W6} \overline{W5}$  signals the tape unit to count three clock signals and record the longitudinal parity character, and triggers a second time delay. This delay causes a gap to be recorded after the data block. After the gap is completed, the tape unit generates a  $\overline{Whs}$  signal to halt the output process. Each character parity and the longitudinal parity of the characters reproduced at the read head are checked by the tape unit and an error signal,  $\overline{Wes}$ , is generated to set  $We$  for any detected errors.

$$sWe = - - - + Wes$$

### SCAN ( $\overline{W9} \overline{W10} \overline{W11}$ )

A forward scan of magnetic tape data blocks is started with an EOM0363X instruction. The process is similar to the magnetic tape reading process except that the character counter is blocked from reaching 00 again after  $W0$  is set by  $\overline{W9} \overline{W6} \overline{W8}$ .

$$sW8 = - - - + \overline{W7} \overline{W9} \overline{W10} \overline{W11} \overline{Wh}$$

This prevents the normal interrupt signals by keeping  $Wf$  from being reset.

$$rWf = \overline{W8} \overline{W7} \overline{W4} (T22-T17) + - - -$$

$$\textcircled{11W} = \overline{Wf} \overline{W0} \overline{Wh} (- - - - -)$$

This allows each input character to precess into the WAR without WIM instructions for setting  $Wf$ . When the end of a data block is reached, an interrupt signal is generated as  $Wf$  is reset.

$$rWf = - - - + \overline{W9} \overline{W10} \overline{W11} \overline{W0} \textcircled{Mtg} \overline{W7} (T22-T17)$$

$$\textcircled{11w} = \overline{Wf} \overline{W0} \overline{Wh} (- - - - -)$$

This interrupt signal calls on the computer to execute a WIM instruction to store the last four characters of the data block from the WAR. Executing the WIM instruction sets  $W7$  and  $Wf$ .

$$sWf = - - - + Wx (T5 - T0) \overline{W4}$$

$$sW7 = - - - + Wx T24 \overline{W4} \overline{Wn}$$

Based on the last four data characters or a block counting program, the computer can reset  $W0$  with another EOM0363X instruction to cause the scan process to continue without a pause through the gap and the next record. If  $W0$  is not reset, the scan process will be terminated by a  $\overline{Whs}$  signal from the tape unit in a manner similar to the manner for terminating magnetic tape input. When the scan process is allowed to terminate, a halt interrupt signal is generated.

$$\textcircled{12w} = \overline{Wf} \overline{Wh} (- - - - -)$$



During the scan process the character parity is checked by the Rp flip-flop and the longitudinal parity is checked by the tape unit (only if W0 is reset after the longitudinal parity character). Any error during the entire scan process will set We as in the magnetic tape input process.

A reverse scan of magnetic tape data blocks is started with an EOM 0763X instruction. The process is similar to a forward magnetic tape scan, except that a WIM instruction at the end of a data block will store the first four data characters in reverse order, and that the longitudinal parity is not properly checked and We may be extraneously set.

In both the Magnetic Tape Forward and Reverse Scan Timing Charts, the first interrupt signal is followed by a WIM instruction to store the last four characters read. The halt interrupt signal informs the computer that the gap has been reached. Wf is shown reset early on termination by  $\overline{W9} \overline{W10} \overline{W11} \overline{W0}$  (Mtg)  $\overline{W7}$  (T22-T17) rather than by the normal  $\overline{W8} \overline{W7} \overline{W4}$  (T22-T17) term. This allows Wh T24 to set W4 for only three 0's precessions rather than four before Wh Wf T0 resets the W Buffer. This has no significance because the WAR is cleared by the preceding WIM instruction.

If, after  $\overline{W9} \overline{W10} \overline{W11} \overline{W0}$  (Mtg)  $\overline{W7}$  (T22-T17) resets Wf to generate an interrupt signal, the WIM instruction is executed after Whs has set Wh; the last four characters read will be stored and a halt interrupt signal will still be generated. This is shown in the Magnetic Tape Forward Scan Timing Chart (late WIM instruction).

If, after  $\overline{W9} \overline{W10} \overline{W11} \overline{W0}$  (Mtg)  $\overline{W7}$  (T22-T17) resets Wf to generate an interrupt signal, the WIM instruction is executed before Whs can set Wh but an EOM 0363X instruction to continue the scan is executed after Whs has set Wh, a halt interrupt signal will be generated.

#### ERASE (W9 W10 W11)

A forward data block erase is started with an EOM 01X7X instruction. The erase process is similar to the magnetic tape output process except the SCR is forced to hold all zeros.

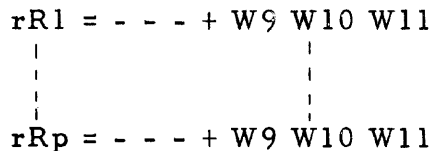

The process flows exactly as with magnetic tape output. Interrupt signals call on the computer to load W each time the WAR is empty. Executing an EOM 14000 instruction after an MIW instruction starts the output process termination. The tape unit generates a (Whs) signal after a gap is recorded to reset the W Buffer and generate a halt interrupt. The read head provides error signals, (Wes) for longitudinal or character parity errors.

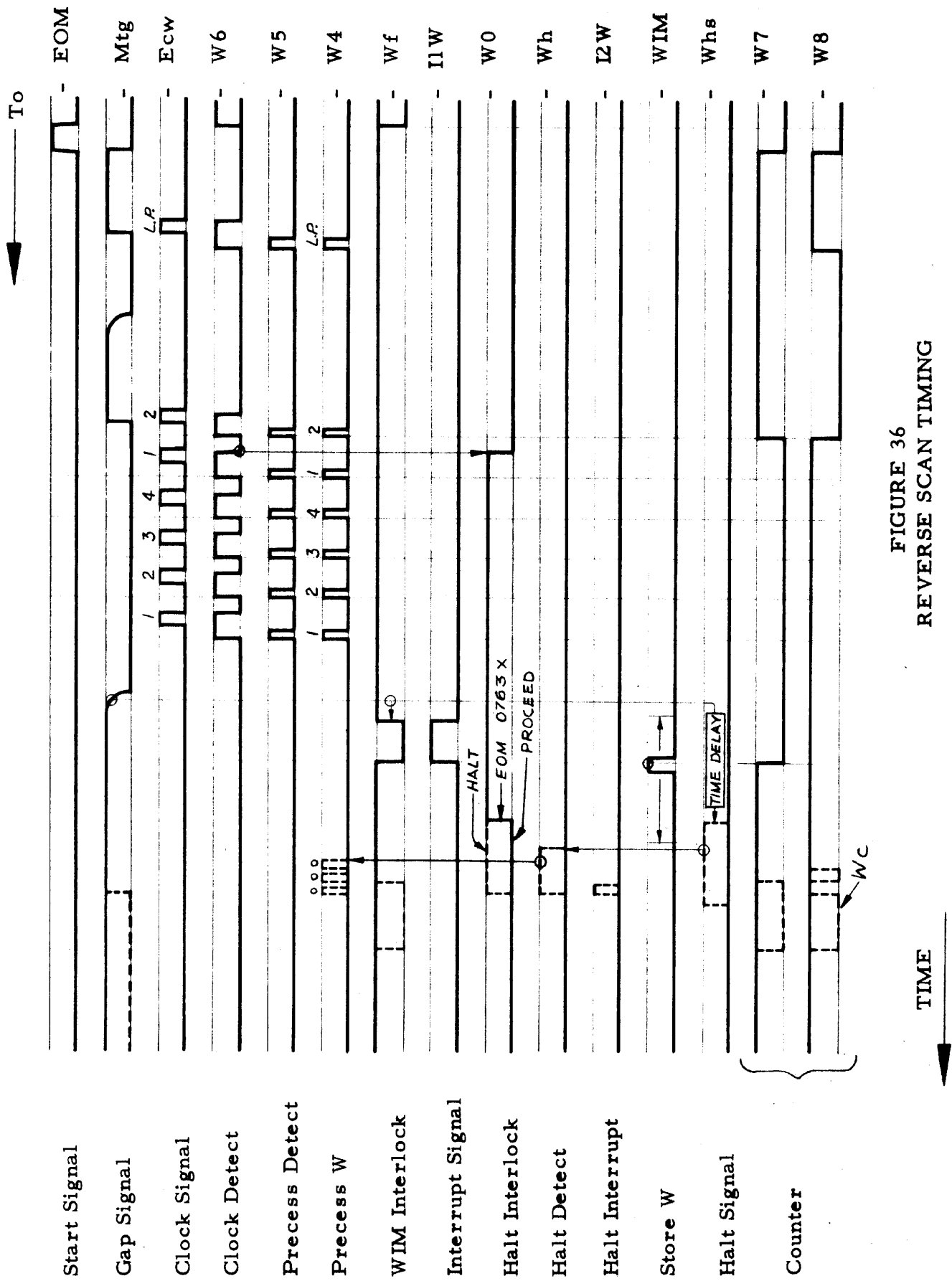

FIGURE 36  
REVERSE SCAN TIMING  
MAGNETIC TAPE

## FILL

Photo-Reader Input 1 is used to fill the computer. First, the Start pushbutton is pressed to make (St) true. (St) makes Wc true to reset the W Buffer.

$$Wc = - - - + (St) (T5-T0)$$

$$rW14 = Wc$$

⋮

$$rW9 = Wc$$

$$rW6 = - - - + Wc$$

$$rW5 = - - - + Wc$$

$$sWf = - - - + Wc \overline{Wh}$$

$$rWh = Wc$$

$$rWe = Wc$$

$$rW0 = Wc + - - -$$

(St) sets the character code to 11 for four characters per word and loads this code into the WAR.

$$sW8 = - - - + (St)$$

$$rW8 = Wc (T22-T17) + - - -$$

$$sW7 = - - - + (St)$$

$$rW7 = Wc (T22-T17) + - - -$$

$$sW4 = - - - + (St) T0$$

$$rW4 = - - - + W4 T24$$

$$rIw = - - - + (St)$$

$$sWw = W4 Tp W8 + W4 T24 W7 + - - - (T24 + Tp) \overline{W4} Wn$$

The fill input process is started by depressing the Fill switch, making  $\text{Kf}$  true.  $\text{Kf}$  is used to set W12.

$$sW12 = \dots + \text{Kf}$$

The input process proceeds and is terminated normally, when the Fill switch is released.

$$Re = \overline{W9} \overline{W10} \overline{W11} W12 \overline{W13} \overline{W14} \overline{Kf}$$

### TIME-SHARE INTERLACE

The interlace system is optional equipment. One can be installed to work in conjunction with the W Buffer and another can be independently installed to work in conjunction with the Y Buffer. No more than two interlace systems can be attached to each 910 or 920 Computer.

The interlace system is "enabled" by an Ioc or Buc instruction that contains a "one" in bit position 9. Therefore, the interlace system can be enabled with the same instruction that sets up the W Buffer (BUC), or it can be enabled without disturbing the W Buffer (Ioc). Either instruction clears the entire interlace system and then sets the enable flip-flop, Ew. (An underlined term represents the "clock"; the trigger occurs when the "clock" falls to zero volts.)

Clear:

$$Iwc = Eom C9 \overline{CI0} \overline{CI7} Q2 + Wh + \text{St}$$

Enable Flip-Flop: .

$$sEw = Eom C9 \overline{CI0} \overline{CI7} \overline{Ew} \underline{Q1}$$

$$rEw = Iwc + \underline{Pot\ 1} Ew$$

$$Pot\ 1 = \overline{F1} F2 \overline{F3} \overline{Ts} \overline{O2} O6$$

With Ew set the computer can preset the interlace register with the starting address and the word count for the input or output process. If the word count is to be greater than 1023, the two most significant bits of the word count register must be preset. This must be done after the system is enabled and before the POT instruction is executed. An Ioc instruction, without bit 9, is given.

$$sIwb = Iwc$$

$$rIwb = Ioc C22 Ew$$

$$sIwa = Iwc$$

$$rIwa = Ioc C23 Ew$$

Note that these two most significant bits of the word count are set by the "clear" pulse and will remain set unless the Ioc instruction resets them. The flip-flops in the rest of the word counter register (Iw0 through Iw9) are reset by the clear pulse and are set by zeros in the C register during the POT instruction. After the POT instruction the word counter register contains the "one's complement" of the desired count. The counter can then count up, not down, and generate the termination signal when all of the flip-flops in the register contain "ones".

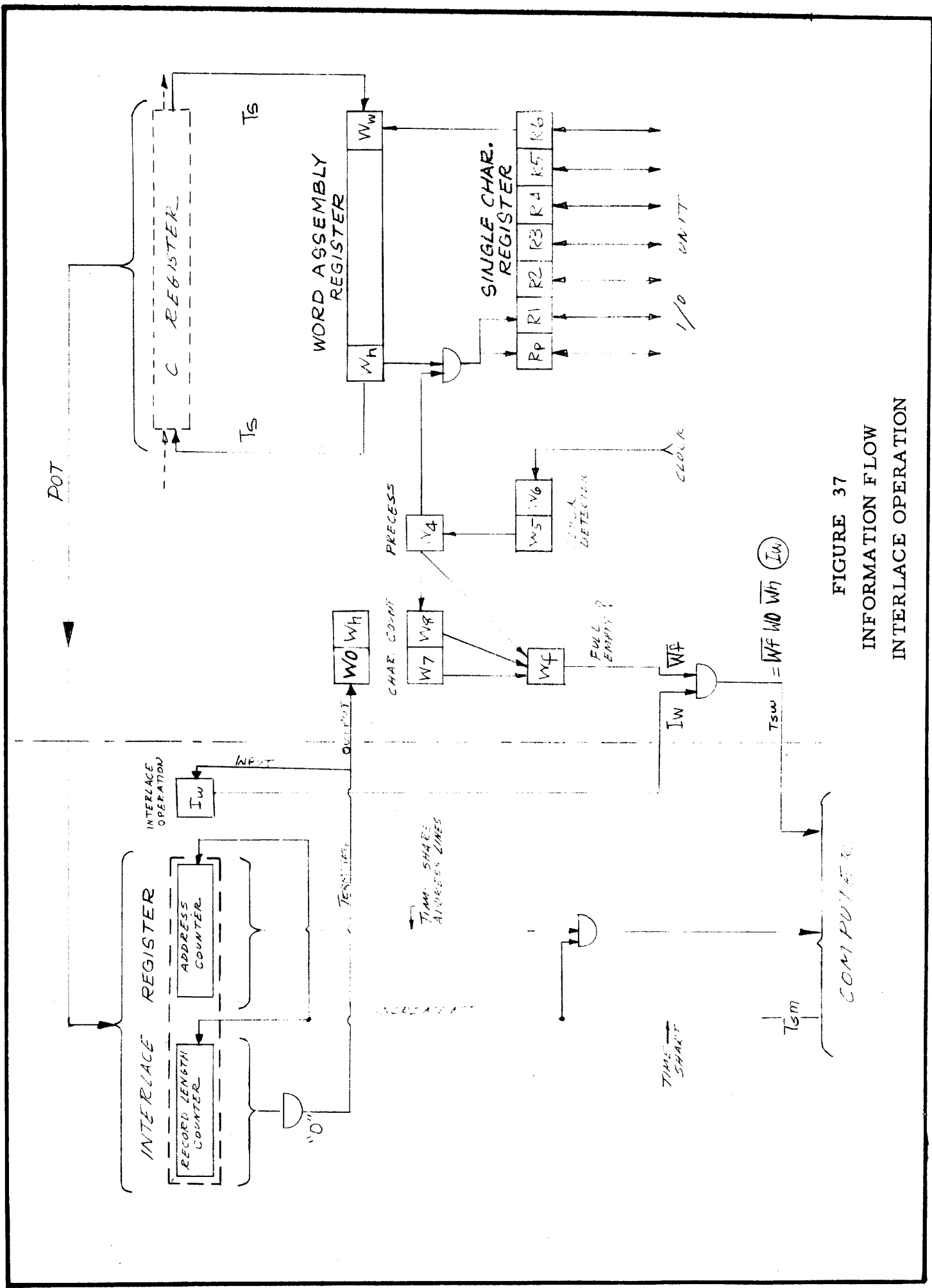

FIGURE 37  
 INFORMATION FLOW  
 INTERLACE OPERATION

The POT instruction sets the interlace counter registers and it also resets Ew and sets Iw.

$$rEw = (\text{Pot } 1) Ew + \dots$$

$$sIw = (\text{Pot } 1) Ew \overline{Iw}$$

Ew furnishes the required "ready" signal for the POT instruction. The Iw and Ew flip-flops inhibit W buffer interrupts and Iw allows the buffer to issue a time-share request signal to the computer whenever the buffer needs memory access. Iw indicates that the interlace is in operation.

$$\text{(Interlace)} \quad Tsw = \overline{Wf} W0 \overline{Wh} \text{ (Iw)}$$

$$\text{(Interrupt)} \quad Ilw = \overline{Wf} W0 \overline{Wh} (En + \text{(En)}) \text{(Ew Iw)}$$

The POT instruction sets the interlace counters:

$$Iws = (\text{Pot } 2) Ew$$

$$sIw0 = Iws \overline{C0} + \underline{Iw} \overline{Iw0}$$

$$rIw0 = Iwc + \underline{Iw} Iw0$$

etc.

(Iw0 "counts" by the falling of the previous stage Iw1)

The address portion of the interlace register (Iw10 through Iw23) is reset by the clear pulse and is set by "ones" from the C register. It too counts up rather than down.

For example:

$$sIw20 = Iws C20 + \underline{Iw21} \overline{Iw20}$$

$$rIw20 = Iwc + \underline{Iw21} Iw20$$

The LSB of both the word counter and the address counter are counted by (Wp Tsm).

$$sIw9 = Iws \overline{C9} + (\underline{Wp} \underline{Tsm}) \overline{Iw9}$$

$$rIw9 = Iwc + (\underline{Wp} \underline{Tsm}) Iw9$$

$$sIw23 = Iws C23 + (\underline{Wp} \underline{Tsm}) \overline{Iw23}$$

$$rIw23 = Iwc + (\underline{Wp} \underline{Tsm}) Iw23$$

When the word count register contains "ones" a signal, Iwf, is generated:

$$Iwf = Iw Iwb Iwa Iw0 Iw1 \dots Iw9$$

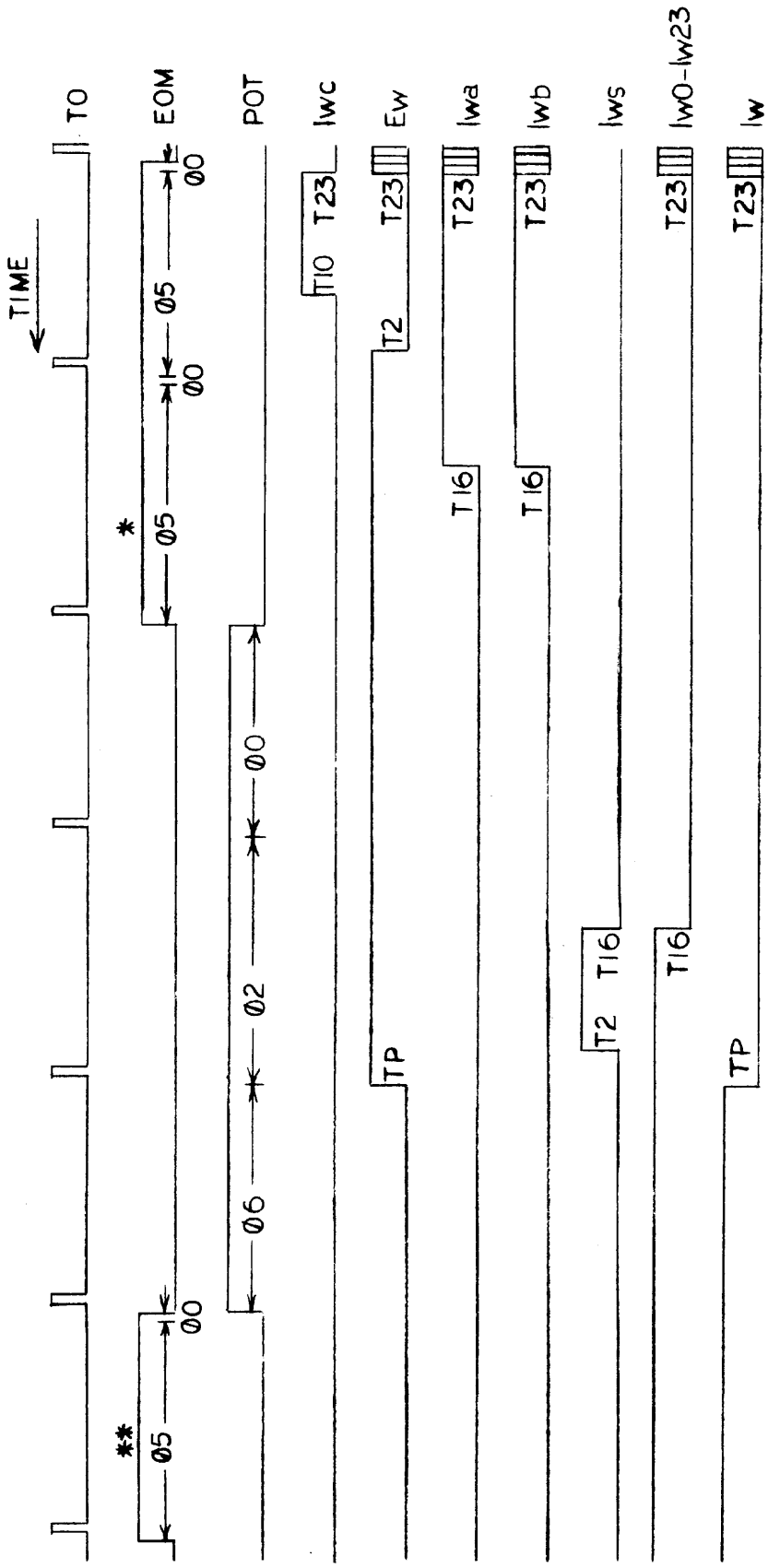

- \* Second EOM is eliminated if not desired to reset lwa or lwb
- \*\* Third EOM (to activate buffer) may be combined with first EOM.

TIME

FIGURE 38  
LOADING THE INTERLACE REGISTER

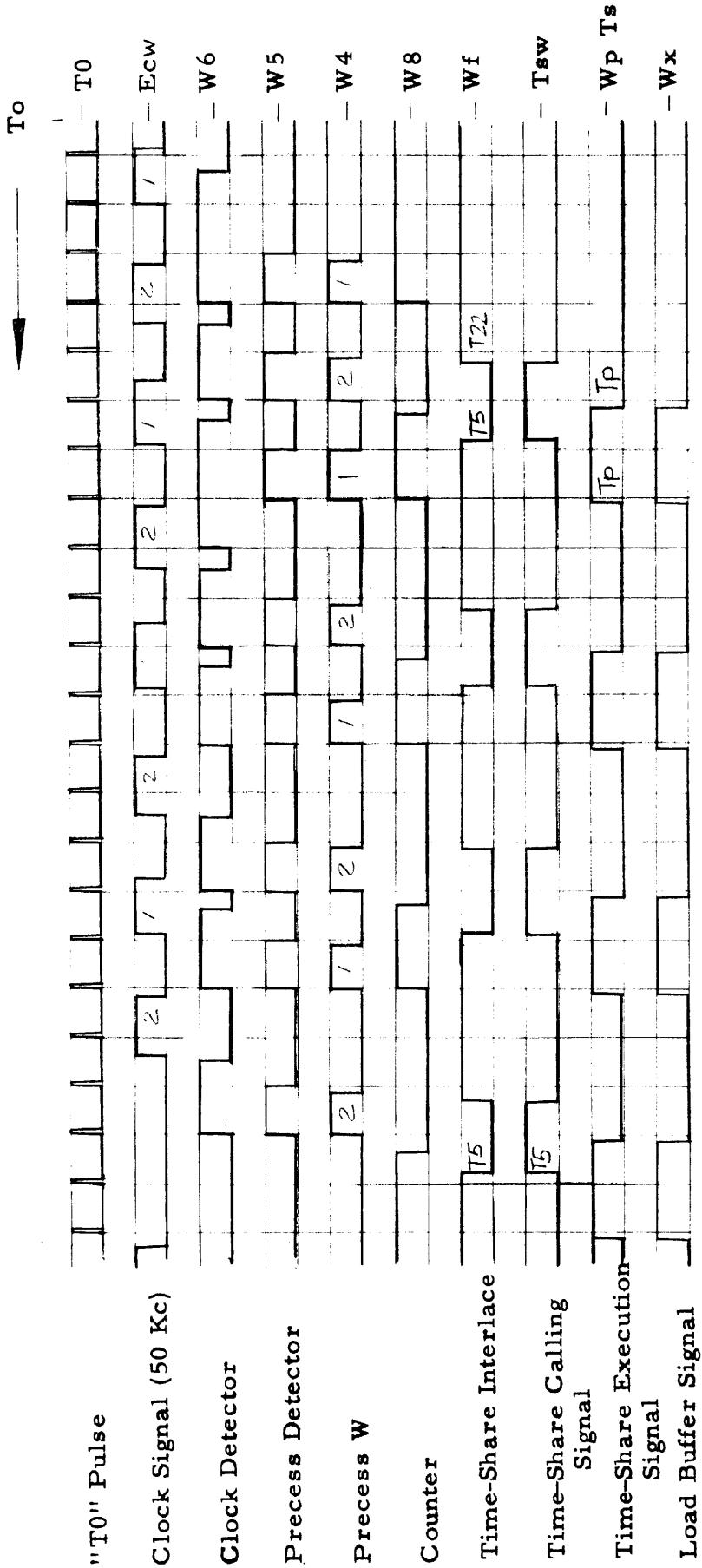

2 Char. / Word

TIME

FIGURE 39  
INPUT/OUTPUT TIMING  
TIME-SHARE



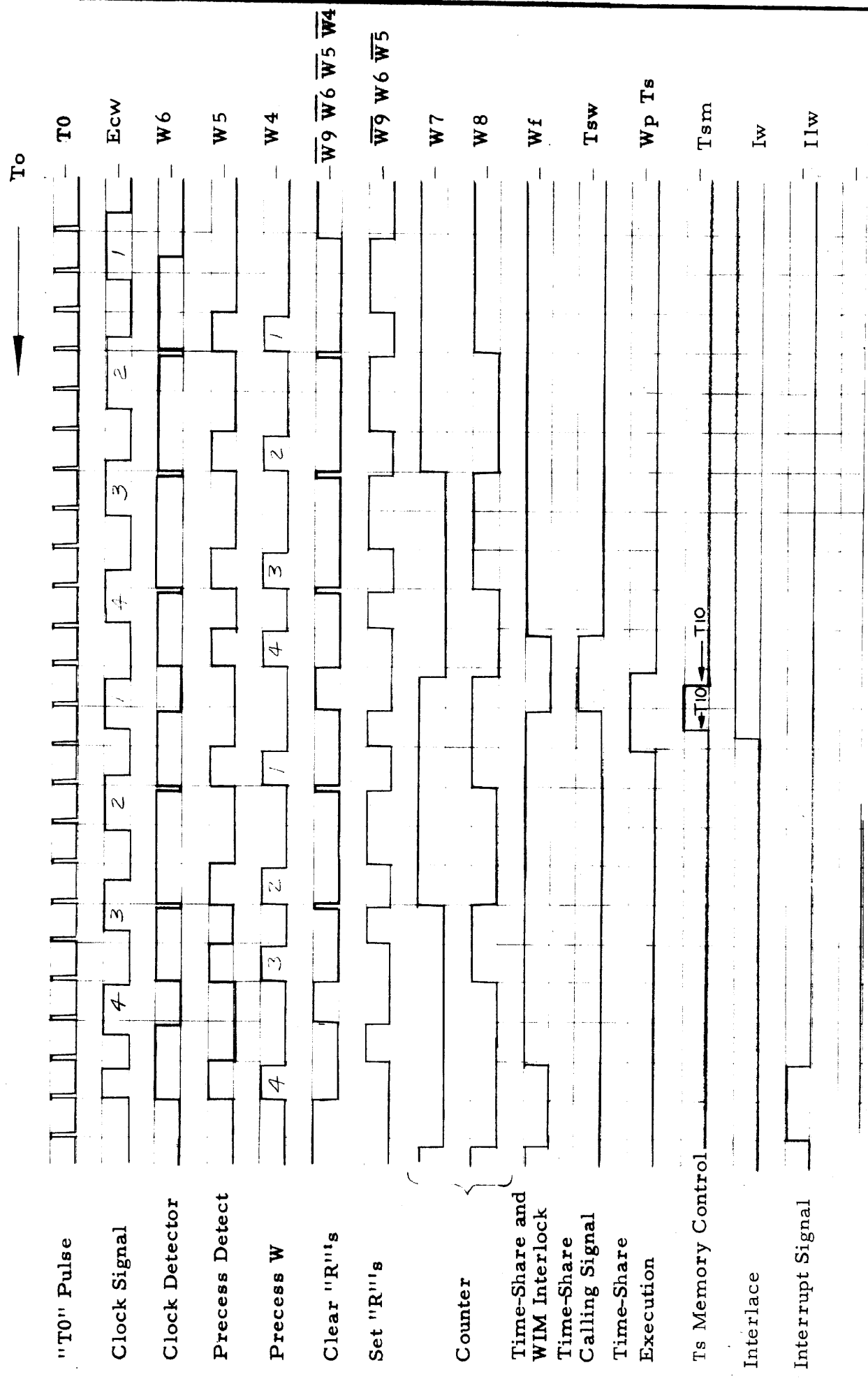

FIGURE 40  
INPUT TERMINATION TIMING  
TIME-SHARE

4 Char/Word  
TIME

If the interlace is controlling an input process ( $\overline{W9}$ ), the Iw flip-flop is reset so that the next time the buffer register is full an I1w interrupt (word ready interrupt) signal will be generated and the interlace register is disengaged.

$$rIw = Iwf Iw \underline{Q1}$$

If the interlace is controlling outputs, the Iwf signal will reset the W0 flip-flop in the W Buffer just before the last character in the W register is precessed to the character register. Signals  $\overline{W0}$  W5 W6 will then set Wh (except in the case of magnetic tape) after the last character has been clocked to the external device. When Wh is set, the interlace register is cleared as well as the W Buffer.

$$rW0 = \underline{Iwf} W9 (T5-T0)$$

$$Iwc = Wh + - - -$$

When the W Buffer is cleared an I2w interrupt (record complete interrupt) signal is generated by the buffer:

$$I2w = \overline{Wf} Wh (En + \underline{En})$$

In the case of magnetic tape outputs, W0 is reset by the interlace signal Iwf. This causes the magnetic tape control to stop writing and stop the tape. After the tape has stopped the tape control unit sets Wh, which clears the W Buffer and the interlace register and allows the I2w interrupt.

An interlace system used in conjunction with the Y Buffer is exactly analogous with the W interlace. The two interlace registers are completely independent of one another.

The four interlace signals to the computer, Iw, Iwf and Iy, Iyf, must be grounded if a corresponding interlace register is not tied to the computer. This is done around the front of the interlace connector 25G if no interlace is connected (4 wires), or around the front of the "repeated" interlace connector at 45L if one interlace is connected (2 wires). If two interlace registers are connected, one plugs to the computer and the second plugs to the first (it does not matter which is W or Y). In this case, none of these four wires should be grounded.

## PHOTO-READER 1

Photo-reader 1 is enabled by unit code 04.

$$Re = \overline{W9} \overline{W10} \overline{W11} W12 \overline{W13} \overline{W14} \overline{Kf}$$

Note: (For photo-reader 2,  $Re = \overline{W9} \overline{W10} \overline{W11} W12 \overline{W13} W14$  for unit code 05).

The pinch roller driver is energized by Re.

$$Rd = \overline{Rb} = Re + Kff$$

The signal from the sprocket channel amplifier is gated by Re.

$$\overline{Re} Sp = \overline{Re} Psp$$



## DICTIONARY OF BUFFER LOGIC TERMS

Buc	A control term derived from the EOM 0XXXX instruction and sent to the W and Y buffers.
Ecw	The eternal clock pulse used to detect inputs, it is generated by the internal clock in each input or output unit.
En	The enable flip-flop enables interrupts to occur in the computer.
(En)	The manual enable switch. This allows interrupts to occur.
EOM	The mnemonic code for the instruction which activates the buffer.
Eom	The execution term for an EOM instruction.
Ew	A flip-flop which enables a POT instruction to load the interlace register.
(I1) - (I4)	Inputs to Is1 - Is4
(I1w)	An interrupt signal, signaling that a WIM or MIW instruction should be executed since the buffer is either full or empty.
(I2w)	An interrupt signal, signaling that the input or output process should be terminated.
Ioc	Input/output control signal derived from the EOM 1XXXX instruction.
Ipl - Ip4	Interrupt program flip-flops that are true when executing the interrupt subroutine for its respective channel.
Is1 - Is4	Interrupt storage flip-flops.
Iw	A flip-flop which determines if memory interlace is in operation.
Iwc	The term which clears the memory interlace registers.
(Iwf)	The signal for halting the input or output process when the record counter has been decremented to zero during memory interlace operation.
Iws	The term which sets the memory interlace register from the C register.
Iwb, Iwa, Iw0 - Iw9	The record length counter in the memory interlace register.
Iw10 - 23	The address counter in the memory interlace register.
(Iw10) - (Iw23)	The address lines to memory from the address counter for memory interlace operation.
(Kf)	The manual fill switch for loading memory from the photo-reader.
Kff	Photo-reader tape feed switch on.
(Mtg)	The magnetic tape gap signal generated by the tape unit.

$\overline{Np}$	No input parity, blocks sWe.
Rb	The brake driver signal for the photo-reader.
R1-R6	The six flip-flops which constitute the character buffer (parity excepted).
Rd	The pinch roller drive signal for the photo-reader.
Re	The enable signal for the photo-reader. This signal is enabled by the EOM unit address.
Rp	The parity flip-flop in the character buffer. An "odd" parity system is used.
$\overline{Rt}$	The term which signals a transfer of interlace information from memory to the interlace register on a POT 0007X instruction.
Sio	An input gate (signal input/output) to the Sks gate (SKIP $\overline{M}$ ).
Sp	The sprocket signal for the photo-reader.
$\overline{St}$	The manual start switch.
Sys	A control signal for system communication derived from the EOM 3XXXX instruction.
Ts	The time-share flip-flop which is on when the buffer has access to memory.
Tsw	The time-share calling signal indicating that the W Buffer desires access to memory.
Wc	The term which clears the unit address register, input/output state, the character counter, and the clock counter. In general, it resets the buffer and prepares it for a new operation.
We	The error flip-flop which will be set, when character parity is incorrect, when magnetic tape parity is incorrect, and when a WIM instruction is executed late. The state of the We flip-flop can optionally be tested for by the input program.
$\overline{Wes}$	Error signal.
Wes	Inverse of $\overline{Wes}$ ; it sets We.
Wf	The flip-flop which in its false state indicates that the W register is full or empty and in its true state allows the buffer to process.
Wh	Halt flip-flop in W Buffer.
$\overline{Whs}$	External halt signal to W Buffer
Whs	Inverse of $\overline{Whs}$ ; it sets Wh.
Wn	The "now" flip-flop on the W register

- W0 The flip-flop which, in general, enables a halt to occur after an input or output process has been initiated and has proceeded to the point that characters are being transferred.
- Wp The flip-flop which designates that the W Buffer is to participate in memory interlace operation.
- Ws The term enabled by an EOM 0X0XX which sets up the W Buffer from the C register.
- Wx The term which allows the W register to be loaded from the C register.
- Ww The "write" flip-flop on the W register.
- W4 The flip-flop which controls the precessing of the data between the character register and the W register.
- W5 The flip-flop which detects that a precess should occur.
- W6 The flip-flop which detects that an input clock is present.
- W7 W8 The flip-flops which constitute the character counter.
- W9 The flip-flop which in its true state designates an output process and in its false state designates an input process.
- W10-W14 The unit address register which designates which I/O unit is to be activated.
- $\overline{Zw1}$  -  $\overline{Zw6}$  The 6 inputs to the 6-bit character buffer.
- $\overline{Zwp}$  The external input to the parity flip-flop Rp.

## W BUFFER AND INPUT/OUTPUT EQUATIONS

### UNIT ADDRESS REGISTER

$$sW14 = Ws C23$$

$$rW14 = Wc$$

$$sW13 = Ws C22$$

$$rW13 = Wc$$

$$sW12 = Ws C21 + \textcircled{Kf}$$

$$rW12 = Wc$$

$$sW11 = Ws C20$$

$$rW11 = Wc$$

$$sW10 = Ws C19 + Ioc \overline{C17} \overline{W9} \overline{C19} \overline{C20} \overline{C21} \overline{C22} \overline{C23} (T5-T0) C12$$

$$rW10 = Wc$$

### INPUT/OUTPUT

$$sW9 = Ws C18$$

$$rW9 = Wc$$

### CHARACTER COUNTER

$$sW8 = Ws C16 + W7 \overline{W8} W4 T0 + Wx T24 Ww$$

$$+ \overline{W7} \overline{W9} W10 W11 \overline{Wh} + \textcircled{St}$$

$$rW8 = Wc (T22 - T17) + W8 W4 T0$$

$$sW7 = Ws C15 + Wx T24 \overline{W4} Wn + \textcircled{St}$$

$$rW7 = Wc (T22 - T17) + W7 \overline{W8} W4 T0$$

### CLOCK COUNTER

(Clock Detector)

$$sW6 = \overline{W5} Ecw (T22 - T17)$$

$$rW6 = W5 T0 + Wc$$

(Precess Detector)

$$sW5 = \overline{W5} W6 \overline{Ecw} T0 + Ws C13 C18$$

$$rW5 = W4 T0 + Wc$$

(Precess W)

$$sW4 = W5 Wf T24 + Ws T0 + Wh T24 + \textcircled{St} T0$$

$$rW4 = W4 T0 + W4 T24$$

### COMPUTER INTERLOCK

$$sWf = Wc \overline{Wh} + Wx (T5 - T0) \overline{W4}$$

$$rWf = \overline{W8} \overline{W7} W4 (T22 - T17) + Ws W9 + \overline{W9} W10 W11 W0 \textcircled{Mtg} \overline{W7} (T22 - T17)$$

### INTERRUPT SIGNALS

$$\textcircled{I1w} = \overline{Wf} W0 \overline{Wh} (En + \textcircled{En})$$

$$\textcircled{\overline{Iw}} \quad \textcircled{\overline{Ew}}$$

$$\textcircled{I2w} = \overline{Wf} Wh (En + \textcircled{En})$$

### TIME-SHARE CALLING SIGNAL

$$Tsw = \overline{Wf} W0 \overline{Wh} \textcircled{Iw}$$



### HALT DETECTOR

$$sWh = Whs T24 + W9 \overline{W11} \overline{W0} W5 \overline{W6} T24 \\ + \overline{W9} \overline{W10} \overline{W11} W12 \overline{W13} (\overline{R1} \overline{R2} \overline{R3} \overline{R4} \overline{R5} \overline{R6} \overline{Rp}) W5 T24$$

$$rWh = Wc$$

### ERROR DETECTOR

$$sWe = \overline{W9} W4 \overline{Rp} (T5 - T0) \overline{Wh} (\textcircled{Np}) + W0 \overline{W6} W5 Ec Tp + Wes$$

$$rWe = Wc \overline{Wh}$$

### SINGLE CHARACTER REGISTER

$$sR1 = W4 Wn \overline{Wx} (\overline{Tp} \overline{T24}) + \overline{W9} W6 \overline{W5} Zw1 + W4 Wx C23$$

$$rR1 = W4 \overline{Wn} \overline{Wx} + \overline{W9} \overline{W6} \overline{W5} \overline{W4} + W9 \overline{W4} W5 \overline{W6} + W9 W10 W11 + W4 Wx \overline{C23}$$

$$sR2 = W4 R1 + \overline{W9} W6 \overline{W5} Zw2$$

$$rR2 = W4 \overline{R1} + \overline{W9} \overline{W6} \overline{W5} \overline{W4} + W9 \overline{W4} W5 \overline{W6} + W9 W10 W11$$

$$sR3 = W4 R2 + \overline{W9} W6 \overline{W5} Zw3$$

$$rR3 = W4 \overline{R2} + \overline{W9} \overline{W6} \overline{W5} \overline{W4} + W9 \overline{W4} W5 \overline{W6} + W9 W10 W11$$

$$sR4 = W4 R3 + \overline{W9} W6 \overline{W5} Zw4$$

$$rR4 = W4 \overline{R3} + \overline{W9} \overline{W6} \overline{W5} \overline{W4} + W9 \overline{W4} W5 \overline{W6} + W9 W10 W11$$

$$sR5 = W4 R4 + \overline{W9} W6 \overline{W5} Zw5$$

$$rR5 = W4 \overline{R4} + \overline{W9} \overline{W6} \overline{W5} \overline{W4} + W9 \overline{W4} W5 \overline{W6} + W9 W10 W11$$

$$sR6 = W4 R5 + \overline{W9} W6 \overline{W5} Zw6$$

$$rR6 = W4 \overline{R5} + \overline{W9} \overline{W6} \overline{W5} \overline{W4} + W9 \overline{W4} W5 \overline{W6} + W9 W10 W11$$

$$sRp = \overline{W9} W4 \overline{Rp} Ww (T22 - T17) + W9 W4 \overline{Rp} Wn (T5 - T0) \overline{Wx}$$

$$+ \overline{W9} W6 \overline{W5} ZwP + W9 W4 (T22 - T17) + W9 W4 \overline{Rp} C23 (T5 - T0) Wx$$

$$rRp = \overline{W9} W4 Rp Ww (T22 - T17) + W9 W4 Rp Wn (T5 - T0) \overline{Wx}$$

$$+ \overline{W9} \overline{W6} \overline{W5} \overline{W4} + W9 \overline{W4} W5 \overline{W6} + W9 W10 W11 + W9 W4 Rp C23 (T5 - T0) Wx$$

### LOAD W FROM C

$$Wx = (\overline{01} \ 03 \ \overline{04} \ 05 \ \overline{06} \ F1 \ \overline{F3}) \overline{Ts} + Wp Ts$$

### CLOCK SIGNAL

$$Ecw = \overline{\overline{Ecw}}$$

## WORD ASSEMBLY REGISTER

$$\begin{aligned} sWw &= W4 R6 \\ &+ W4 Tp W8 \\ &+ W4 T24 W7 \\ &+ (\overline{T24} \overline{Tp}) \overline{W4} Wx C23 + (T24 + Tp) \overline{W4} Wn \\ &+ \overline{W4} Wn \overline{Wx} \end{aligned}$$

$$rWw = (\overline{sWw})$$

$sWn = Ww$  delayed by 24 pulse times

$rWn = \overline{Ww}$  delayed by 24 pulse times

## CLEAR AND SET SIGNALS

$$Wc = Buc \overline{C17} (T22 - T17) + Wh \overline{Wf} T0 + \textcircled{St} (T5 - T0)$$

$$Ws = Buc \overline{C17} (T5 - T0)$$

$$W \text{ Buffer Ready} = \overline{W9} \overline{W10} \overline{W11} \overline{W12} \overline{W13} \overline{W14}$$

$$WIM \text{ and } MIW \text{ interlock} = \overline{Wf} (W0 + \overline{W9})$$

## HALT INTERLOCK

$$sW0 = \overline{W9} W6 \overline{W8} + Ws W9$$

$$rW0 = Wc + Ioc C12 \overline{C17} \overline{C19} \overline{C20} \overline{C21} \overline{C22} \overline{C23} (T5 - T0) + W9 \textcircled{Iwf} (T5 - T0)$$

## MAGNETIC TAPE CONTROL SIGNALS

$$\text{Stop Read Interlock} = W0$$

$$\text{Output Character Interlock} = \overline{W5}$$

## INTERLACE LOGIC

### Clear

$$Iwc = Eom C9 \overline{CI0} \overline{CI7} Q2 + Wh + \textcircled{St}$$

### Prepare

$$sEw = Eom C9 \overline{CI0} \overline{CI7} \underline{Q1} \overline{Ew}$$

$$rEw = Iwc + \underline{Pot 1} Ew$$

### Load Registers

$$Iws = Pot 2 Ew$$

### Interlace

$$sIw = \underline{Pot 1} Ew \overline{Iw}$$

$$rIw = Iwc + Iwf \underline{Q1} Iw$$

### Finished

$$Iwf = Iw Iwb Iwa Iwo Iw1 Iw2 Iw3 Iw4 - - - Iw9$$

### Ready

$$\textcircled{\overline{Rt}} = \textcircled{\overline{Ew}}$$

### Word Count

$$sIwb = Iwc + \underline{Iwa} \overline{Iwb}$$

$$rIwb = Ioc C22 Ew + \underline{Iwa} Iwb Iw$$

$$sIwa = Iwc + \underline{Iwo} \overline{Iwa}$$

$$rIwa = Ioc C23 Ew + \underline{Iwo} Iwa$$

$$sIwo = Iws \overline{Co} + \underline{Iw1} \overline{Iwo}$$

$$rIwo = Iwc + \underline{Iw1} Iwo$$

$$\vdots$$
$$sIw9 = Iws \overline{C9} + (\underline{Tsm Wp}) \overline{Iw9}$$

$$rIw9 = Iwc + (\underline{Tsm Wp}) Iw9$$

Address

$$sIw10 = Iws C10 + \underline{Iw11} \overline{Iw10}$$

$$rIw10 = Iwc + \underline{Iw11} Iw10$$

$$sIw23 = Iws C23 + (\underline{Tsm Wp}) \overline{Iw23}$$

$$rIw23 = Iwc + (\underline{Tsm Wp}) Iw23$$

## PHOTO READER 1

### ENABLE SIGNAL

$$R_e = \overline{W_9} \overline{W_{10}} \overline{W_{11}} W_{12} \overline{W_{13}} \overline{W_{14}} \overline{K_f}$$

### PINCH ROLLER AND LAMP DRIVERS

$$R_d = \overline{R_b} = R_e + K_{ff}$$

### READER SIGNALS

$$\textcircled{Z_{w1}} = \overline{(\text{Ch 6 amp}) R_e}$$

$$\textcircled{Z_{w2}} = \overline{(\text{Ch 5 amp}) R_e}$$

$$\textcircled{Z_{w3}} = \overline{(\text{Ch 4 amp}) R_e}$$

$$\textcircled{Z_{w4}} = \overline{(\text{Ch 3 amp}) R_e}$$

$$\textcircled{Z_{w5}} = \overline{(\text{Ch 2 amp}) R_e}$$

$$\textcircled{Z_{w6}} = \overline{(\text{Ch 1 amp}) R_e}$$

$$\textcircled{Z_{wp}} = \overline{(\text{Ch 7 amp}) R_e}$$

$$\textcircled{E_{cw}} = \overline{(\text{Z}_{w1} + \text{Z}_{w2} + \text{Z}_{w3} + \text{Z}_{w4} + \text{Z}_{w5} + \text{Z}_{w6} + \text{Z}_{wp} + W_0) S_p R_e}$$

### BRAKE DRIVER

$$R_b = \overline{R_e} \textcircled{K_{ff}}$$



## Y BUFFER EQUATIONS

### UNIT ADDRESS REGISTER

$$sY14 = Y_s C23$$

$$rY14 = Y_c$$

$$sY13 = Y_s C22$$

$$rY13 = Y_c$$

$$sY12 = Y_s C21$$

$$rY12 = Y_c$$

$$sY11 = Y_s C20$$

$$rY11 = Y_c$$

$$sY10 = Y_s C19 + I_{oc} C17 \overline{Y_9} \overline{C19} \overline{C20} \overline{C21} \overline{C22} \overline{C23} (T5 - T0) C12$$

$$rY10 = Y_c$$

### INPUT/OUTPUT

$$sY9 = Y_s C18$$

$$rY9 = Y_c$$

### CHARACTER COUNTER

$$sY8 = Y_s C16 + Y7 \overline{Y8} Y4 T0 + Y_x T24 Y_w + \overline{Y9} \overline{Y7} Y10 Y11 \overline{Y_h} + (St)$$

$$rY8 = Y_c (T22 - T17) + Y8 Y4 T0$$

$$sY7 = Y_s C15 + Y_x T24 \overline{Y4} Y_n + (St)$$

$$rY7 = Y_c (T22 - T17) + Y7 \overline{Y8} Y4 T0$$



## CLOCK COUNTER

(Clock Detector)

$$sY6 = \overline{Y5} Ecy (T22 - T17)$$

$$rY6 = Y5 T0 + Yc$$

(Precess Detector)

$$sY5 = \overline{Y5} Y6 \overline{Ecy} T0 + Ys C13 C18$$

$$rY5 = Y4 T0 + Yc$$

(Precess Y)

$$sY4 = Y5 Yf T24 + Ys T0 + Yh T24 + \textcircled{St} T0$$

$$rY4 = Y4 T0 + Y4 T24$$

## COMPUTER INTERLOCK

$$sYf = \overline{Y4} Yx (T5 - T0) + Yc \overline{Yh}$$

$$rYf = \overline{Y8} \overline{Y7} Y4 (T22 - T17) + Ys Y9 + \overline{Y9} Y10 Y11 Y0 \textcircled{MtgY} \overline{Y7} (T22 - T17)$$

## INTERRUPT SIGNALS

$$\textcircled{I1y} = \overline{Yf} Y0 \overline{Yh} (En + \textcircled{En}) \quad \textcircled{\overline{Iy}} \quad \textcircled{\overline{Ey}}$$

$$\textcircled{I2y} = \overline{Yf} Yh (En + \textcircled{En})$$

## TIME-SHARE CALLING SIGNAL

$$Tsy = \overline{Yf} Y0 \overline{Yh} \textcircled{Iy}$$

HALT DETECTOR (See Note)

$$\begin{aligned} sY_h &= Y_h s T_{24} + Y_9 \overline{Y_{11}} \overline{Y_0} Y_5 \overline{Y_6} T_{24} \\ &\quad + \overline{Y_9} \overline{Y_{10}} \overline{Y_{11}} Y_{12} \overline{Y_{13}} (\overline{R_{1Y}} \overline{R_{2y}} \overline{R_{3y}} \overline{R_{4y}} \overline{R_{5y}} \overline{R_{6y}} \overline{R_{py}}) Y_5 T_{24} \\ rY_h &= Y_c \end{aligned}$$

ERROR DETECTOR (See Note)

$$\begin{aligned} sY_e &= \overline{Y_9} Y_4 \overline{R_{py}} (T_5 - T_0) \overline{Y_h} (\overline{N_p}) + Y_0 \overline{Y_6} Y_5 E_{cy} T_p + Y_{es} \\ rY_e &= Y_c \overline{Y_h} \end{aligned}$$

SINGLE CHARACTER REGISTER (See Note)

$$\begin{aligned} sR_{1y} &= Y_4 Y_n \overline{Y_x} (\overline{T_p} \overline{T_{24}}) + \overline{Y_9} Y_6 \overline{Y_5} Z_{y1} + Y_4 Y_x C_{23} \\ rR_{1y} &= Y_4 \overline{Y_n} \overline{Y_x} + \overline{Y_9} \overline{Y_6} \overline{Y_5} \overline{Y_4} + Y_9 \overline{Y_4} Y_5 \overline{Y_6} + Y_9 Y_{10} Y_{11} \\ &\quad + Y_4 Y_x \overline{C_{23}} \\ sR_{2y} &= Y_4 R_{1y} + \overline{Y_9} Y_6 \overline{Y_5} Z_{y2} \\ rR_{2y} &= Y_4 \overline{R_{1y}} + \overline{Y_9} \overline{Y_6} \overline{Y_5} \overline{Y_4} + Y_9 \overline{Y_4} Y_5 \overline{Y_6} + Y_9 Y_{10} Y_{11} \\ sR_{3y} &= Y_4 R_{2y} + \overline{Y_9} Y_6 \overline{Y_5} Z_{y3} \\ rR_{3y} &= Y_4 \overline{R_{2y}} + \overline{Y_9} \overline{Y_6} \overline{Y_5} \overline{Y_4} + Y_9 \overline{Y_4} Y_5 \overline{Y_6} + Y_9 Y_{10} Y_{11} \\ sR_{4y} &= Y_4 R_{3y} + \overline{Y_9} Y_6 \overline{Y_5} Z_{y4} \\ rR_{4y} &= Y_4 \overline{R_{3y}} + \overline{Y_9} \overline{Y_6} \overline{Y_5} \overline{Y_4} + Y_9 \overline{Y_4} Y_5 \overline{Y_6} + Y_9 Y_{10} Y_{11} \end{aligned}$$

$$sR5y = Y4 R4y + \overline{Y9} Y6 \overline{Y5} Zy5$$

$$rR5y = Y4 \overline{R4y} + \overline{Y9} \overline{Y6} \overline{Y5} \overline{Y4} + Y9 \overline{Y4} Y5 \overline{Y6} + Y9 Y10 Y11$$

$$sR6y = Y4 R5y + \overline{Y9} Y6 \overline{Y5} Zy6$$

$$rR6y = Y4 \overline{R5y} + \overline{Y9} \overline{Y6} \overline{Y5} \overline{Y4} + Y9 \overline{Y4} Y5 \overline{Y6} + Y9 Y10 Y11$$

$$sRpy = \overline{Y9} Y4 \overline{Rpy} Yw (T22 - T17) + Y9 Y4 \overline{Rpy} Yn (T5 - T0) \overline{Yx}$$

$$+ \overline{Y9} Y6 \overline{Y5} Zyp + Y9 Y4 (T22 - T17) + Y9 Y4 \overline{Rpy} C23 (T5 - T0) Yx$$

$$rRpy = \overline{Y9} Y4 Rpy Yw (T22 - T17) + Y9 Y4 Rpy Yn (T5 - T0) \overline{Yx}$$

$$+ \overline{Y9} \overline{Y6} \overline{Y5} \overline{Y4} + Y9 \overline{Y4} Y5 \overline{Y6} + Y9 Y10 Y11 + Y9 Y4 Rpy C23 (T5 - T0) Yx$$

LOAD Y FROM C (from computer)

$$Yx = (\overline{01} \ 03 \ \overline{04} \ \overline{05} \ \overline{06} \ F1 \ \overline{F3}) \overline{Ts} + \overline{Wp} Ts$$

CLOCK SIGNAL

$$Ecy = \overline{\textcircled{Ecy}}$$

### WORD ASSEMBLY REGISTER (See Note)

$$sYw = Y4 \text{ (R6y)} + Y4 T_p Y8 + Y4 T_{24} Y7 + (\overline{T_{24}} \overline{T_p}) \overline{Y4} Y_x C_{23} \\ + (T_{24} + T_p) \overline{Y4} Y_n + \overline{Y4} Y_n \overline{Y_x}$$

$$rYw = (\overline{sYw})$$

$sY_n = Y_w$  delayed by 24 pulse times

$rY_n = \overline{Y_w}$  delayed by 24 pulse times

### CLEAR AND SET SIGNALS

$$Y_c = \text{Buc } C_{17} (T_{22} - T_{17}) + Y_h \overline{Y_f} T_0 + \text{(St)} (T_5 - T_0)$$

$$Y_s = \text{Buc } C_{17} (T_5 - T_0)$$

$$Y \text{ Buffer Ready} = \overline{Y_9} \overline{Y_{10}} \overline{Y_{11}} \overline{Y_{12}} \overline{Y_{13}} \overline{Y_{14}}$$

$$YIM \text{ and } MIY \text{ interlock} = \overline{Y_f} (Y_0 + \overline{Y_9})$$

### HALT INTERLOCK

$$sY_0 = \overline{Y_9} Y_6 \overline{Y_8} + Y_s Y_9$$

$$rY_0 = Y_c + \text{Ioc } C_{12} C_{17} \overline{C_{19}} \overline{C_{20}} \overline{C_{21}} \overline{C_{22}} \overline{C_{23}} (T_5 - T_0) + Y_9 \text{ (Iyf)} (T_5 - T_0)$$

### MAGNETIC TAPE CONTROL SIGNALS

Stop Read Interlock =  $Y_0$

Output Character Interlock =  $\overline{Y_5}$

## Y BUFFER EXTENSION

NOTE: When the Y Buffer extension is used the following modifications are required in the Y Buffer Logic.

$$(1) \text{ sYh} = \text{Yhs T24} \\ + \overline{\text{Y9}} \overline{\text{Y11}} \overline{\text{Y0}} \text{Y5} \overline{\text{Y6}} \text{T24} \\ + \overline{\text{Y9}} \overline{\text{Y10}} \overline{\text{Y11}} \text{Y12} \overline{\text{Y13}} (\overline{\text{R1y}} \overline{\text{R2y}} \overline{\text{R3y}} \overline{\text{R4y}} \overline{\text{R5y}} \overline{\text{R6y}} \overline{\text{R7y}} \overline{\text{R8y}} \overline{\text{Rpy}}) \text{Y5 T24}$$

$$(2) \text{ sYe} = \overline{\text{Y9}} \overline{\text{Yh}} (\text{Np}) \overline{\text{Y4}} \text{Y5 Rpe} \\ + \text{Y0} \overline{\text{Y6}} \text{Y5 Ecy Tp} \\ + \text{Yes}$$

$$(3) \text{ sRpy} = \overline{\text{Y9}} \text{Y6} \overline{\text{Y5}} \text{Zyp} \\ + \text{Y4 Y9 (T22 - T17)}$$

$$\text{rRpy} = \overline{\text{Y9}} \text{Y4 Rpy Yw (T22 - T17)} \\ + \text{Y9 Y4 Rpy (T5 - T0)} \overline{\text{Yx}} \\ + \overline{\text{Y9}} \overline{\text{Y6}} \overline{\text{Y5}} \overline{\text{Y4}} \\ + \text{Y9} \overline{\text{Y4}} \text{Y5} \overline{\text{Y6}} \\ + \text{Y9 Y10 Y11} \\ + \text{Y9 Y4 Rpy C23 (T5 - T0) Yx}$$

$$(4) \text{ sYw} = \text{Y4 (Least significant bit of R register)} \\ + \text{Y4 Tp Y8} \\ + \text{Y4 T24 Y7} \\ + (\overline{\text{T24}} \overline{\text{Tp}}) \overline{\text{Y4}} \text{Yx C23} \\ + (\text{T24} + \text{Tp}) \overline{\text{Y4}} \text{Yn} \\ + \overline{\text{Y4}} \text{Yn} \overline{\text{Yx}}$$

### Reset R Register

$$RRy = \overline{Y9} \overline{Y6} \overline{Y5} \overline{Y4} + Y9 \overline{Y4} Y5 \overline{Y6} + Y9 Y10 Y11$$

### Enable R Register

$$ERy = \overline{Y9} Y6 \overline{Y5}$$

### Parity

Rpe = Even number of ones in information bits.

### R Register

$$sR7y = Y4 R6y + ERy Zy7$$

$$rR7y = Y4 \overline{R6y} + RRy$$

$$sR24y = Y4 R23y + ERy Zy24$$

$$rR24y = Y4 \overline{R23y} + RRy$$

## SECTION III

### MAGNETIC CORE MEMORY

NOTE: This section applies only to core memory units that use QK53 and HK55 type modules.

## INTRODUCTION

This section explains the logical and electronic operation of the core memory in detail. Layout, wiring information, and additional circuitry information are contained in a separate manual.

The reader should be familiar with Memory Control, Page 1.39, in Section 1 of this manual.

The computer uses a parallel, random access, coincident current, magnetic core memory for permanent storage of all internal data and instructions.

Each individual bit in each data or instruction word is stored in an individual magnetic element called a core. These ferrite cores are the basic storage elements and are capable of representing one of two logical states, i. e., one-zero, true-false. The ferrite cores are physically arranged as the points of a three-dimensional coordinate system; the X and Y coordinates of a specific core represent the address of the word of which that core is a member; the Z coordinate determines which bit of the word the core represents. Thus, a single column of cores (i. e., all cores with the same X and Y coordinates) represents a single word. Through all of the cores on each Z level or digit plane there are two wires used for the reading and writing of information. Below is an example of selecting word number 12<sub>8</sub>.

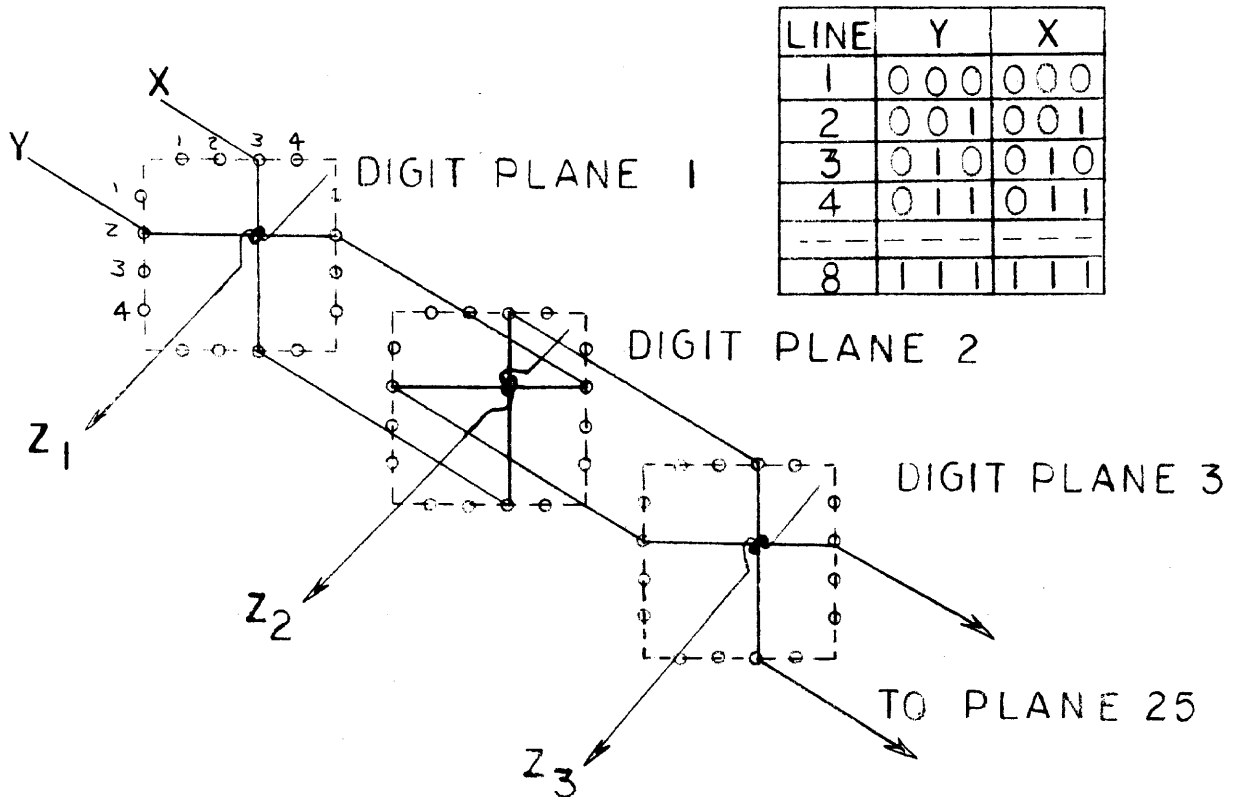



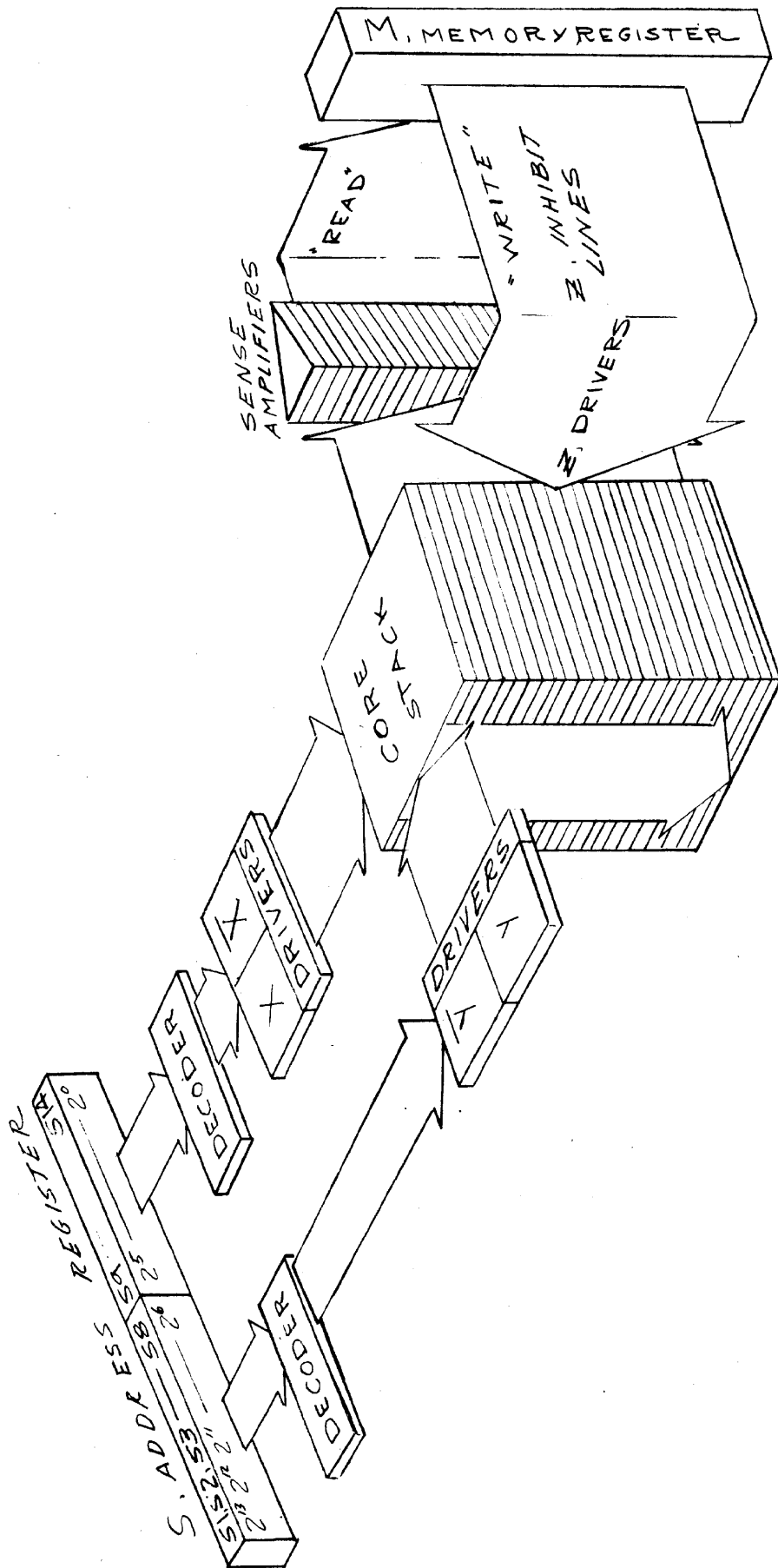

FIGURE 41.  
 BLOCK DIAGRAM  
 MAGNETIC CORE MEMORY

The Z coordinate wires are used for parallel detection of information or for indirectly writing information. The block diagram of the magnetic core memory shows the parallel outputs of the S (address) register being decoded into X and Y coordinate signals. To reduce the complexity and number of components in the address system, the X and Y coordinates are sub-divided into  $X$ ,  $\bar{X}$ ,  $Y$ , and  $\bar{Y}$ . These decoded address signals correspondingly drive current driver circuits whose output lines pass through the cores on the X and Y coordinates.

The 25 (25 bits per word) Z coordinate windings (hereafter called sense windings) are fed to 25 sense or detection amplifiers which detect the state of the cores in the specific word being addressed; and this information is fed in parallel to the M (memory) register for later transfer to the C register.

Note that although the sense windings pass through all cores in a specific plane, only the state of the addressed core will be detected, due to the required coincidence of the X and Y coordinates.

When writing into memory from the M register, the outputs of the  $\bar{M}$  side of the M flip-flops drive 25 Z drivers that correspondingly drive a second set of Z windings, which are used to inhibit the insertion of "ones" in the respective cores requiring "zeros". The reasons for this technique will be explained later.

The reading of information from a core memory of this type is destructive in that all of the cores in the addressed word are left in a "zero" state; therefore, the information read into the M register must be regenerated (written back) into the same address position before proceeding. When regenerating or writing into a word position, the X and Y coordinates will attempt to set all cores at the coincidence points to the "one" state. Note that previously they have all been reset to the zero state by a reading process. The inhibit or Z windings will therefore inhibit the setting of cores requiring zeros, and the correct information is written into the word location. The process of reading and then immediately regenerating is called a memory cycle and takes 6 microseconds to completely execute.

## MAGNETIC CORE STORAGE THEORY

The elementary storage element, the ferrite core, whose principal characteristic is a rectangular, hysteresis loop, is shown in Figure 42.  $H$  is the magnetizing force (proportional to the applied current) applied to the core, and  $B$  is the magnetic flux (proportional to the magnetic permeability of the material) produced in the core by the force  $H$ . If the force  $H_t$  is applied to the core, the flux density in the "one" direction will increase to  $\Phi_m$ , which represents maximum flux density or saturation. When the magnetizing force  $H_t$  is removed, the flux density will decrease to the  $\Phi_r$  value, which represents the remanent or residual flux density that (for a constant  $\Phi_m$ ) is proportional to the retentivity or remanence of the material. The core is now said to be in the "one" state.

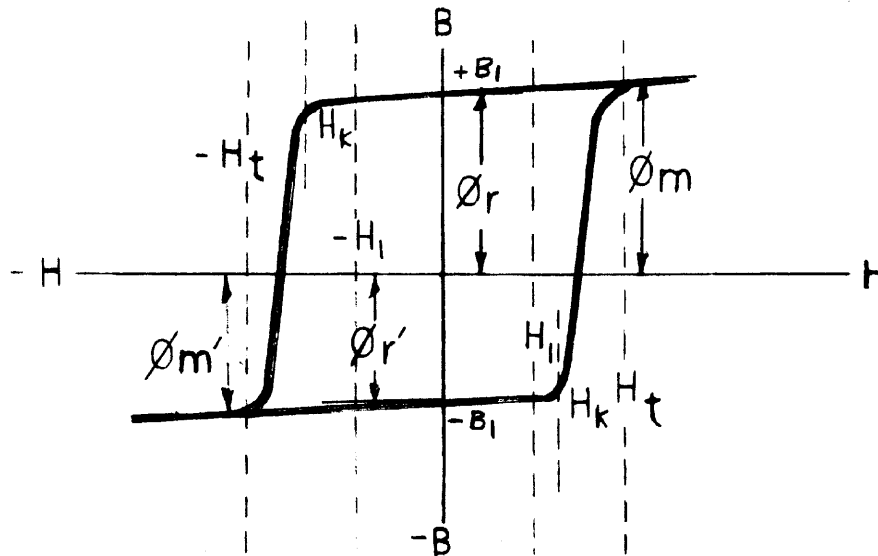

Figure 42 Hysteresis Loop

If the magnetizing force is applied in the opposite direction  $-H_t$  (reverse the current), the remanent flux density  $\Phi_r'$  will be  $-B_1$  and the core will be in the "zero" state. Note that although the  $\Phi_r'$  value approximately equals the previous residual flux density value, the direction of the flux has completely reversed.

The designations of "zero" and "one" for a magnetic core are completely arbitrary and are only in relationship to the polarities of the applied signals, sense, and inhibit windings.

The high squareness ratio ( $H_k/H_t$ ) of the hysteresis loop makes it possible to apply magnetizing forces which are less than that required to saturate the core in either direction, without materially changing the value of the magnetic flux density of the core. An abrupt reversal of the flux direction will take place when the magnetizing force exceeds a critical value. The reversal of the magnetic flux direction switches the core to the complement of its present state. The core will stay indefinitely in

either state until switched back by a sufficient electromotive force applied in the opposite direction to the force which set it initially.

The critical values, the knee, and the squareness ratio, permit the coincident-current type of operation which required the coincidence of two partial magnetizing

forces,  $\frac{Ht}{2}$  or  $\frac{-Ht}{2}$ , each of which alone is less than the magnetizing force required to drive the core past the knee (point  $H_k$ ) of the curve of the hysteresis loop shown in Figure 42. The two partial magnetizing forces, acting simultaneously, are sufficient to change the state of the core. The two partial magnetizing forces are supplied by two drive half-currents applied along X and Y drive lines, respectively. The switching action of the coincident partial magnetizing forces can be prevented by the application of an inhibit current whose value is equal, but whose direction is opposite, to either one of the write drive half-currents. The resulting inhibit magnetizing force cancels the effect of one of the partial magnetizing forces and prevents the core from switching to the other of its two stable states.

The state of a core at a given moment can be determined by the application of read drive current in the direction that would switch the core to the zero state. If the core is already in the zero state, the read drive current will drive it minutely into saturation, but no flux reversal will take place, and only a small amount of flux variation will result. If on the other hand, the core is in the "one" state, it will be switched to the "zero" state by the read drive current, the direction of the magnetic flux will be reversed, and the relative flux variation will be very large. In both cases the flux variations will appear in the form of a voltage induced in a sense winding. If the flux density is varied with time at a rate  $d\Phi/dt$ , then, according to Faraday's law, a voltage  $V$  is induced across the windings of magnitude:

$$V = -N \frac{d\Phi}{dt}$$

where  $N$  equals the number of turns, which in this case, would be one. The signal voltage pulse shown below permits the determination of the state that the core was in before the application of the read drive current. All magnetic cores in a matrix are linked by the X and Y drive lines, the inhibit winding, and the sense winding as shown below:

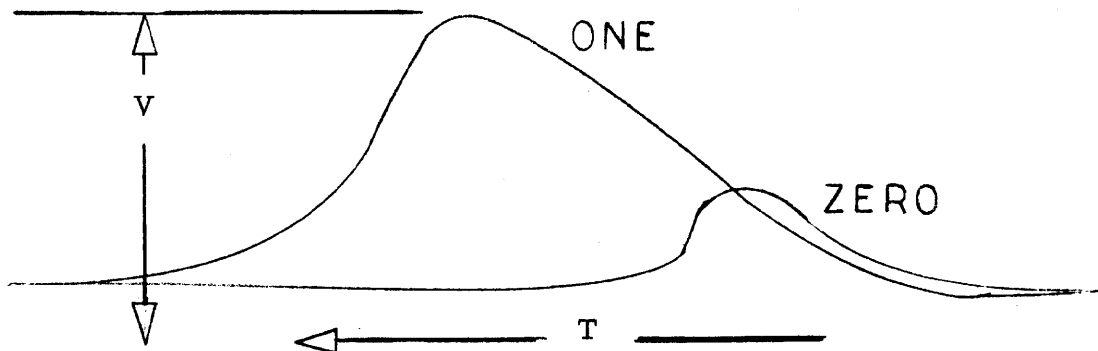

Each selected X and Y drive line carries a drive half-current that applies a partial magnetizing force to all magnetic cores linked by those lines. The core located at the intersection of the selected drive lines will receive the sum of the two partial magnetizing forces, which will be sufficient to produce the magnetic flux reversal and change the state of the core.

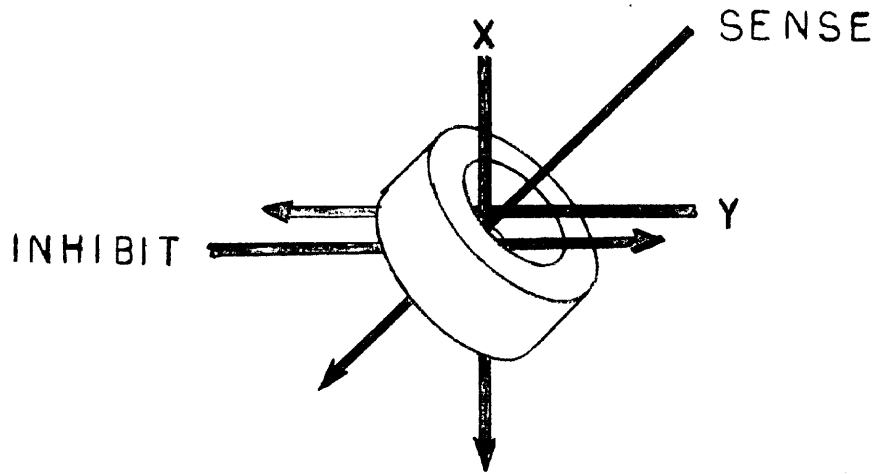

The X and Y drive lines are connected to the X and Y decoders and traverse all digit planes in series. During the read operation, the direction of the drive current in the matrix is such that the core at the selected address would be switched to zero. As explained above, the cores that are in the one state will produce voltage pulses in the sense winding, while those that are in the zero state will produce virtually no signal. Each matrix or digit plane has its own individual sense winding, which will thus read the bit stored in that digit plane at the selected address. When the information is being written into the matrix, write or restore drive half-currents are applied to the selected X and Y drive lines in the direction opposite to that of the read drive currents, so that the core at the drive lines intersection would be switched to the one state. However, in the case of matrices in which a zero has been written, an inhibit current is applied through the inhibit winding that is individual for each matrix. The inhibit current is approximately of the same magnitude as an X or Y drive current and will prevent the core located at the intersection of the selected X and Y drive lines from being switched to one; a zero bit will remain stored in that matrix at the selected address. Each inhibit winding intersects all cores on a given digit plane.

## BASIC OPERATION

### ADDRESSING

The 14 outputs of the S register (address register) are gated into 14 address lines designated L1 through L14 as shown below:

$$\begin{aligned} \overline{L1} &= S1 \overline{Tsm} + (Iw10) (Tsm Wp) + (Iy10) (Tsm \overline{Wp}) \\ &\vdots \\ \overline{L14} &= S14 \overline{Tsm} + (Iw23) (Tsm Wp) + (Iy23) (Tsm \overline{Wp}) \\ L1 &= \overline{\overline{L1}} \\ &\vdots \\ L14 &= \overline{\overline{L14}} \end{aligned}$$

Note that the address lines from the buffer interlace system enter at this point.

The 14 address lines are decoded into the X and Y coordinates according to the following chart:

$2^{13}$	$2^{12}$	$2^{11}$	$2^{10}$	$2^9$	$2^8$	$2^7$	$2^6$	$2^5$	$2^4$	$2^3$	$2^2$	$2^1$	$2^0$
S1	S2	S3	S4	S5	S6	S7	S8	S9	S10	S11	S12	S13	S14
L1	L2	L3	L4	L5	L6	L7	L8	L9	L10	L11	L12	L13	L14
		Y Coordinate						X Coordinate					
		Y			$\overline{Y}$			X			$\overline{X}$		

The X and Y coordinates each represent 6 bits or two octal digits. These coordinates are divided into  $\overline{X}$ , X,  $\overline{Y}$ , and Y, each of which consist of a single octal digit that can be decoded into 8 specific configurations.

The L1 and L2 positions, hereafter referred to as  $2^{13}$  and  $2^{12}$ , are used to define which 4096-word memory stack is being addressed.

- $2^{13} 2^{\overline{12}}$  = stack one, locations 0(0) to 07777 (4095)
- $2^{\overline{13}} 2^{12}$  = stack two, locations 10000 (4096) to 17777 (8191)
- $2^{13} 2^{\overline{12}}$  = stack three, locations 20000 (8192) to 27777 (12287)
- $2^{\overline{13}} 2^{12}$  = stack four, locations 30000 (12288) to 37777 (16383)

Four decoders are thus required and are shown in Figure 43. The decoding function for a single octal digit is performed by an individual circuit module designated QK52, which has one output for each of the eight possible states.

The current path for an X or Y drive line originates at a solid state circuit which acts as a current source and will be called a "switch." The current path terminates in a solid state circuit which acts as a current sink and will be called a "sink." Any X or Y drive line requires two switches and two sinks, as the current must be reversible between the read and write operations.

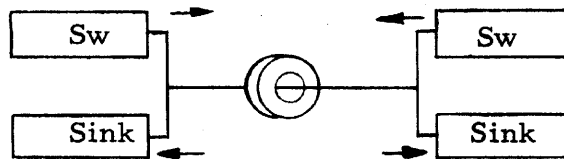

The combination of 8  $\overline{X}$  sw-sink pairs and 8 X sw-sink pairs provides selection of one of 64 X coordinate drive lines, and in a similar manner the 6 bits representing the Y coordinate selects one of 64 Y drive lines. The 4096 intersections of the 64 X drive lines and 64 Y drive lines provide selection of 4096 core storage locations.

Due to the requirement that the X and Y drive currents must reverse between the read phase and the write phase, two separate signals will be required to determine the direction of the drive current. These signals are designated  $R_w$  and  $W_r$ .

$$R_w = Mg \overline{Q2}$$

$$W_r = (Mg Q2) (Mdt + Q1)$$

Due to the fact that the cores alternate in their relative positions to the physical drive lines, the current must pass in the opposite direction for all even-numbered drive lines with respect to all odd-numbered drive lines. To implement this, the external connections on even-numbered lines are reversed as shown below:

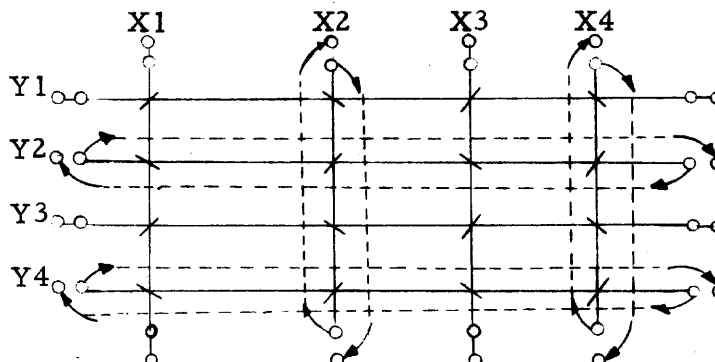





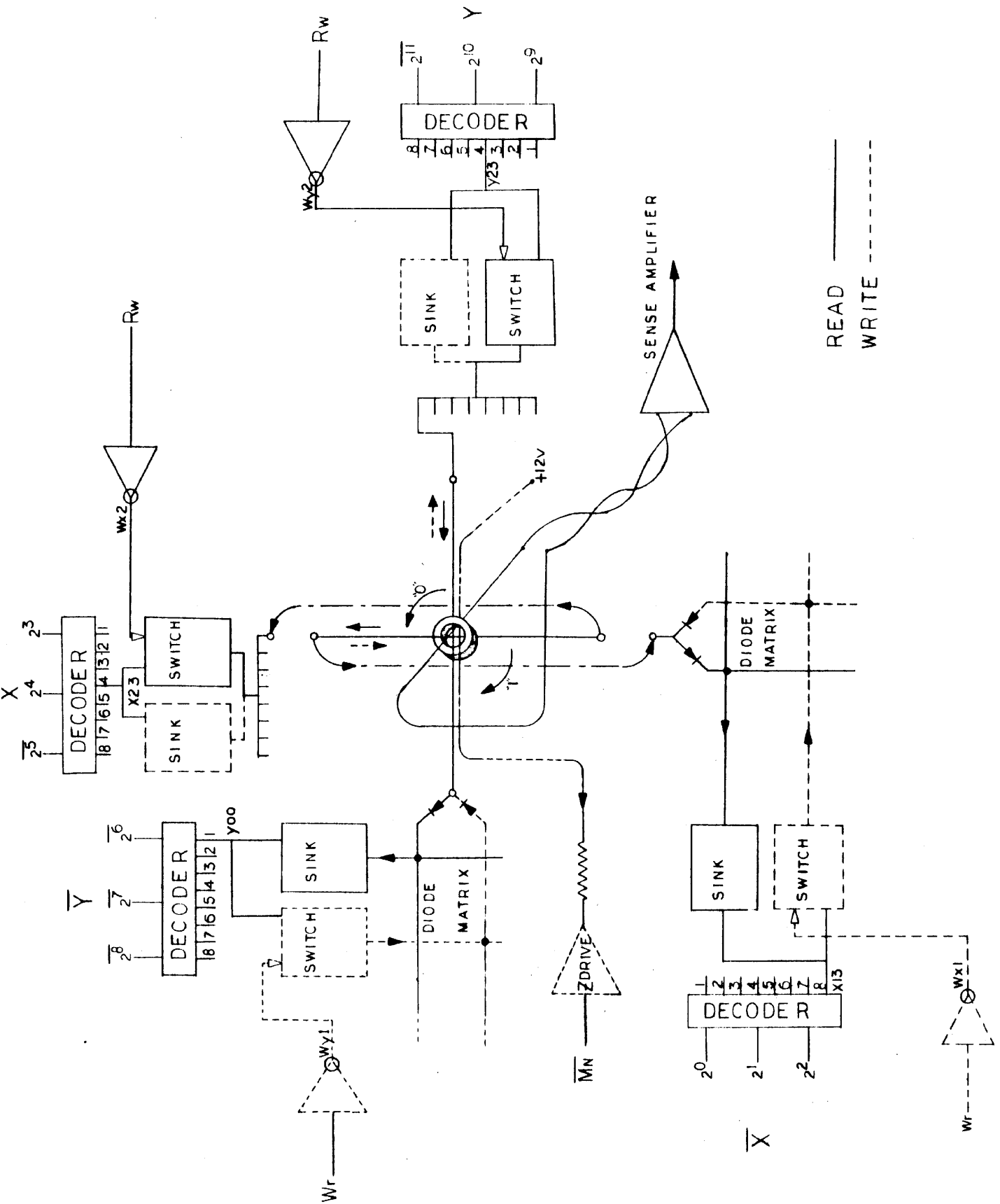

Figure 44. Operation of Address 3037

Figure 44 shows the selection of address 3037 and the control of the direction of the X and Y drive currents by the above-described Rw and Wr terms.

Figure 43 shows the overall structure of an individual 4096-word core stack with the circuit module types and numbers designated. These modules are listed and briefly described below:

<u>Module</u>	<u>Quantity</u>	<u>Function</u>
QK52	4	Decoding of an octal character for address selection.
QK53	4	8 sw-sink combinations for driving the selected line.
HK52	3	Z coordinate, inhibit drivers.
HK59	5	Sense Amplifier.
HK51	2	Discriminator, detects the digital information from the amplifier.
SK58	1	Current regulator, gates and supplies the current to the sinks and switches.
HK55	2	Control, generates and distributes the inhibit terms for $2^{12}$ and $2^{13}$ and also distributes the current direction selection terms Wr and Rw.
SK53	1	Voltage Regulator, generates the + 12 voltage for the inhibit lines and the current regulator.
SK57	1	Operates in parallel with the SK53.

Figure 46 shows the core stack in detail. Note that this is approximately a one-sixteenth model in that one-sixteenth the actual number of cores in a single digit plane are shown. It is suggested that the reader trace the directions of current flow, for both the read and write phases of the memory cycle, for the following addresses:

0070	3760
3037	3747

This diagram also shows the inhibit and sense windings. Note that the inhibit winding passes through all cores in the direction of the Y-axis, and that the sense winding traces diagonally through all cores on the digit plane.

### READ CYCLE

At pulse time T10 of the computer cycle, the S (Address) register is cleared by Sc in preparation for receiving a new address. At T9 time, a new address is transferred to the S register, the decoders will immediately decode the new information, and the outputs of the decoders will assume a new configuration. At pulse time T8, the M (Memory) register will be cleared by Mc in preparation for

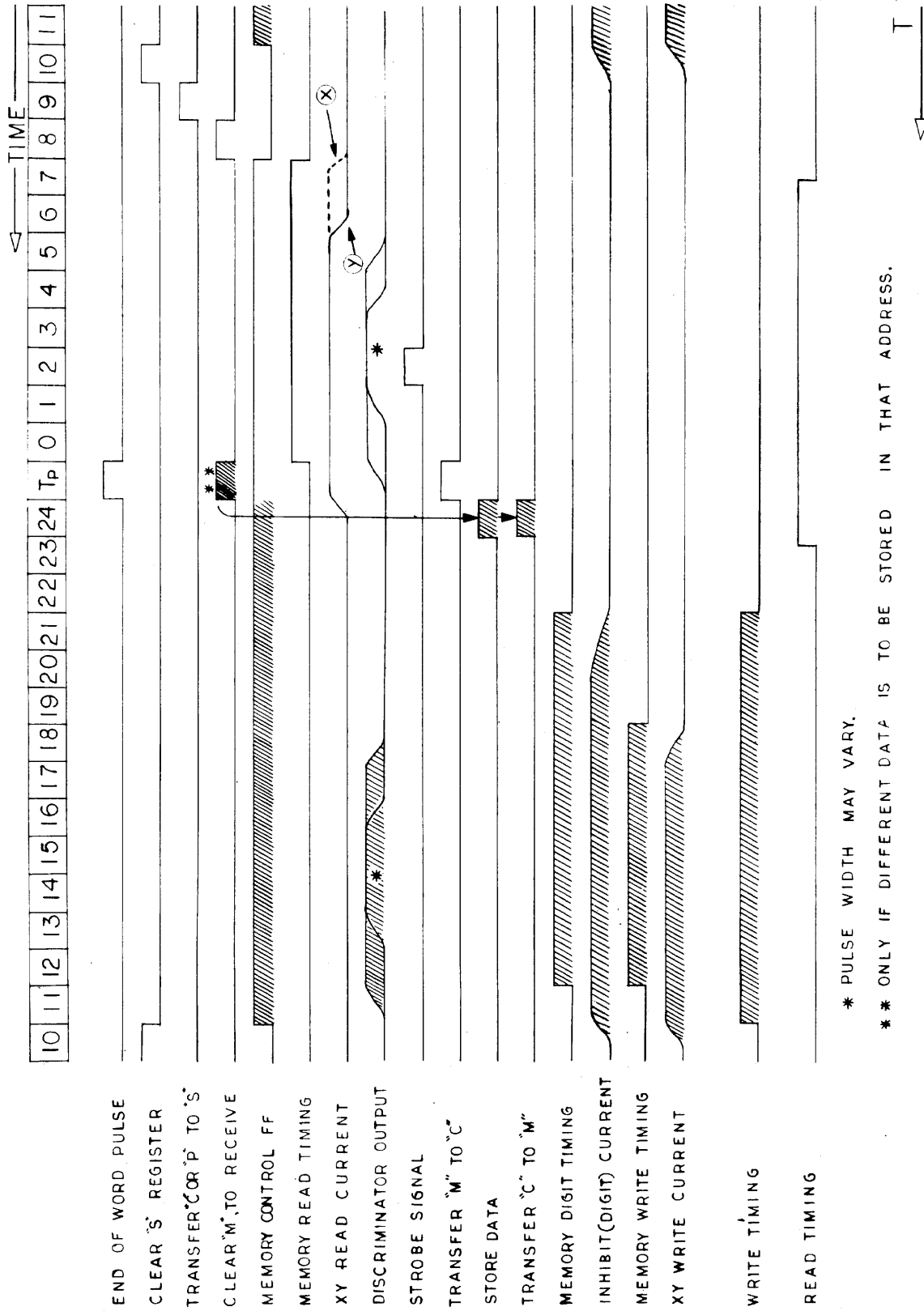

\* PULSE WIDTH MAY VARY.

\*\* ONLY IF DIFFERENT DATA IS TO BE STORED IN THAT ADDRESS.

Figure 45. Computer Memory Cycle

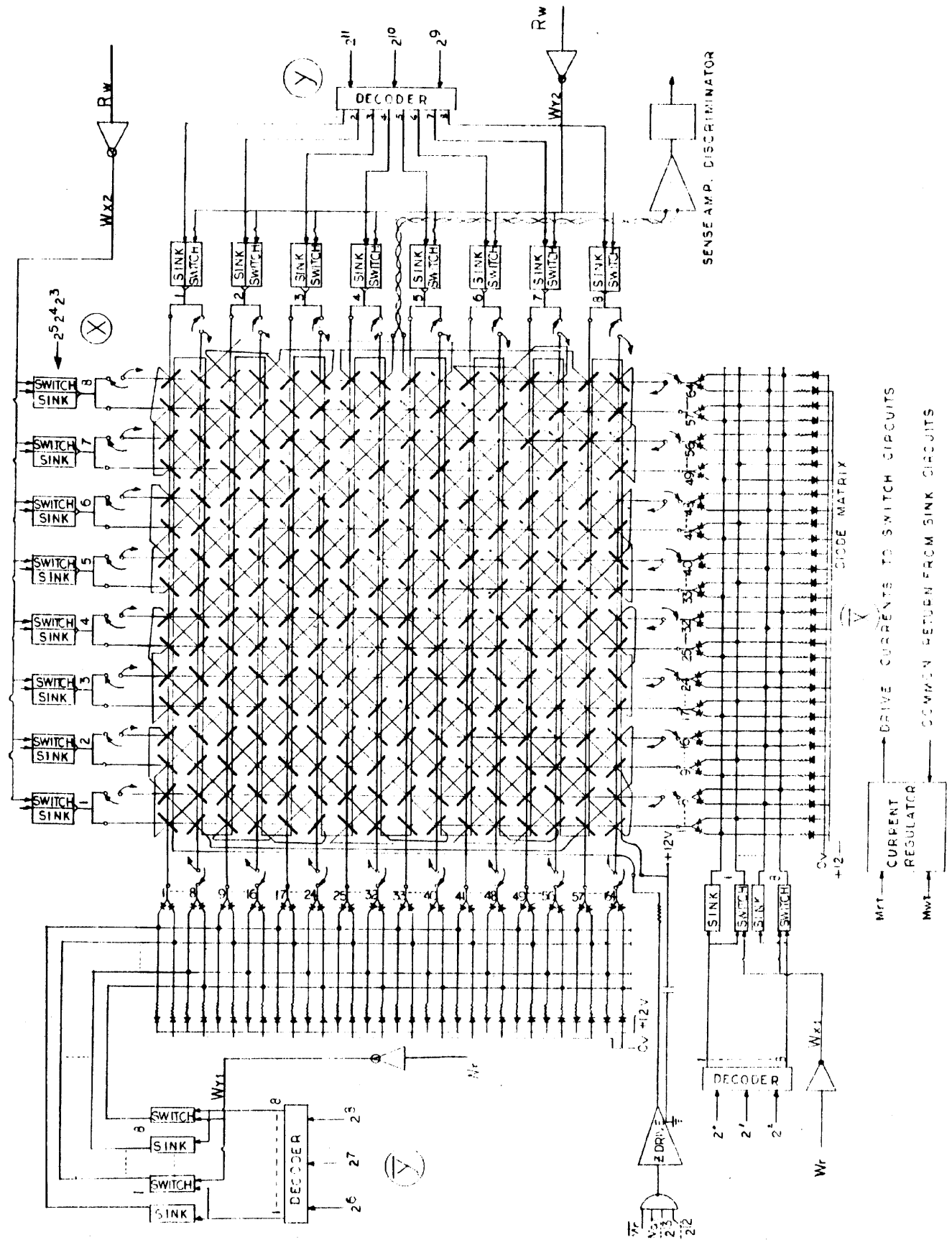
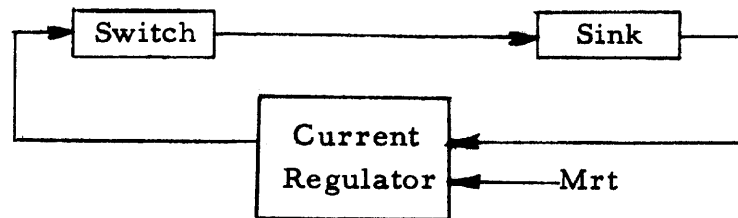

Figure 46. Memory Digit Plane Diagram

receiving data from memory, and the Mg flip-flop will be set, initiating a new memory cycle. When Mg goes true, this will also qualify the current direction signals Rw and Wyl.

At pulse time T7, the memory read timing signal (Mrt) will be enabled for a duration of 8 pulse times. Mrt controls the current regulator circuits which supply the current to all of the switch and sink circuits:



The decoders selected the proper switches and sinks at T7 time, and current is supplied to the drive line by Mrt which, in turn, activates the current regulator.

During the read cycle, all of the X and Y drive line half-currents are applied in a direction which will drive all of the cores in the zero direction. The voltage outputs of the digit planes are sensed by 25 sense amplifiers which feed their respective outputs to 25 discriminator circuits which detect the large signal change; and at T2 time, this information is clocked into the M register by the Ms (strobe) signal.

At Tp time, the Mrt signal is disabled which, in turn, disables the current regulator, and no more current is supplied to the X and Y drive line paths.

### WRITE CYCLE

The write cycle consists of regenerating the present contents of M into the address from which it was just read, or of inserting new information into the M register at T24 time for storage into the address that was just read.

In either case, the contents of the S (address) register will not change, as the address must be the same; therefore, the output configuration of the decoders will remain as they were during the read cycle.

At pulse time T21, the Mdt (memory digit timing) signal is enabled. The Mdt signal enables the Z (inhibit) drivers whose inputs are qualified by the Mn signal. The current for the Z drivers is not supplied by the current regulator modules, but by the voltage regulator so that inhibit current will flow from T21 until T8.

At T18 time, the Mwt (memory write timing) signal will be enabled which, in turn, will enable the current regulator to supply current to the sinks and switches in a fashion similar to Mrt. Note that during the write phase the address selection is the same, but the direction of all drive line half-currents is reversed due to Wr and Wy2 now being enabled.

Voltages will be generated on the sense lines during the write cycle due to the write

drive currents setting cores to the one position and will be generated from the inhibit currents, but these voltages are not strobed by Ms and are always ignored.

At T12 time, the Mwt signal is disabled and the X and Y drive current sources are inhibited.

## MEMORY EXPANSION

The memory of the computer can be expanded to contain 4 core stacks of 4096 words each. Figure 47 shows the addressing system used when expanding the memory to other configurations.

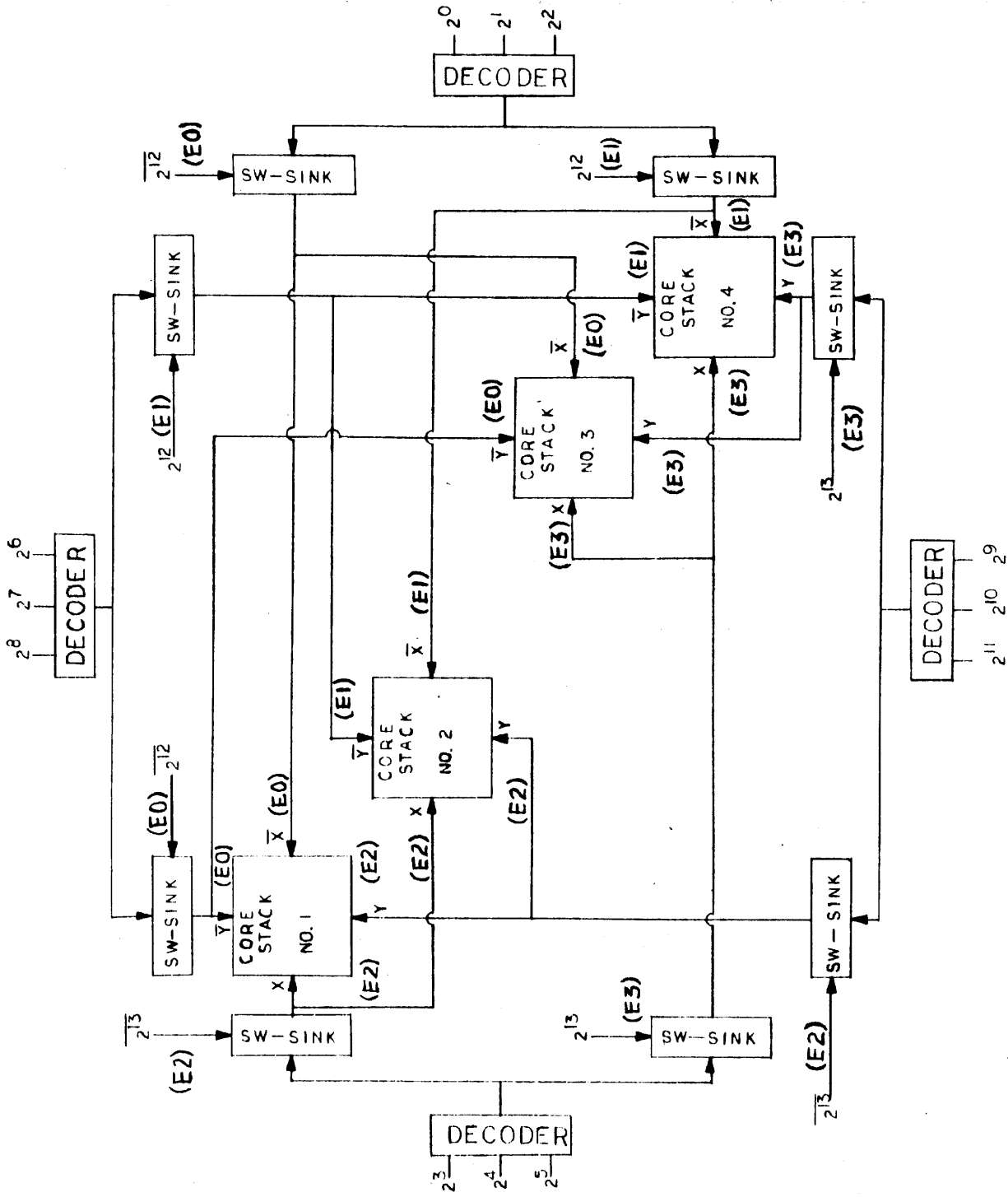

Figure 47. Block Diagram - Memory Expansion



## MODULE OPERATION

### DECODER

The decoder module, designated QK52, produces an output signal (+) on one of eight output lines to represent one of eight possible input configurations. Both the true and false sides of the three bits to be decoded ( $2^n 2^{n+1} 2^{n+2}$ ) are supplied to the module.

The decoding is performed by a series of negative "AND" gates such that the inverted output will be the correct result. The eight output lines feed to one or more sets of 8 sw-sink modules (depending upon the size of memory) and will act as the enabling address terms.

### SELECTOR CONTROL

The selector control module, designated HK55, generates the current direction control terms, the stack selection control terms, and the stack selection terms, for the inhibit drivers.

Two HK55 modules are connected together to generate the required complement of control terms. On the first HK55, two current direction terms are generated from Wr. These are Wx1 and Wy1. On the second HK55, two similar terms, Wx2 and Wy2, are generated from Rw. These four current direction control terms are fed to the four sw-sink modules.

The two most significant computer address terms L1 and L2 are used to generate four stack selection terms E0, E1, E2, and E3. These stack selection terms are coded with Mdt (inhibit or digit timing) to generate four inhibit control signals, designated D1, D2, D3, and D4. The stack selection signals E0, E1, E2, and E3 are also used to enable the sw-sink modules in each of the four stacks.

### XY SELECTOR

The XY Selector modules designated QK53 contain eight sets of switch-sink circuits for selecting the proper X or Y drive line.

The eight address signals from the respective decoder module are connected to pins 39, 37, 33, 30, 24, 20, 14, and 11, respectively. If the specific address input signal is true (ANDed with the stack zero signal E0), it will enable the switch-sink pair to conduct current when directed by the Rw and Wr signals.

The switch circuit gates the drive current onto the appropriate XY drive line where the current passes through a sink circuit to return to the current regulator.

When the current direction control signals invert (between read and write), the mating sink circuit will be enabled and will receive current from the same XY drive line.

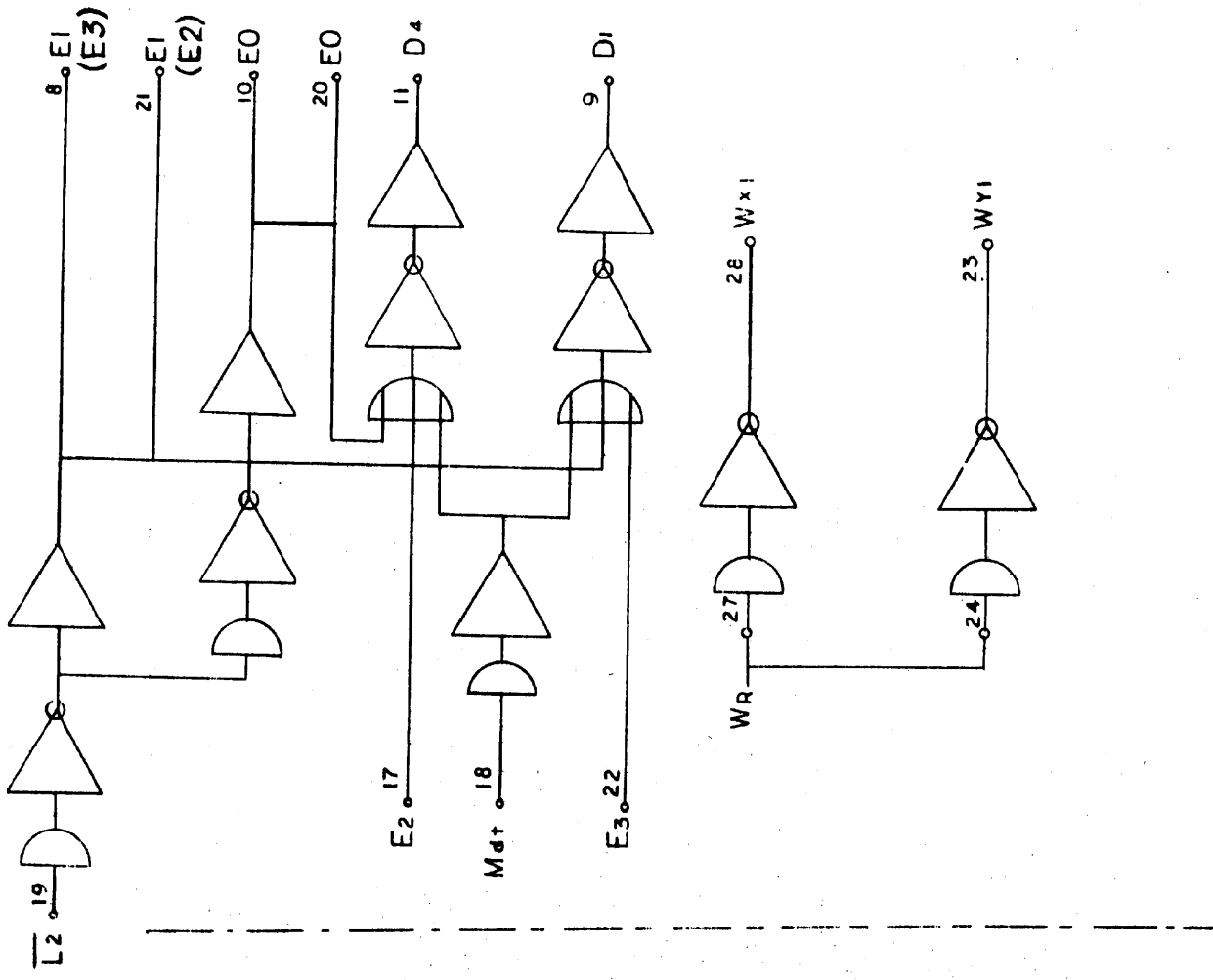

HK 55

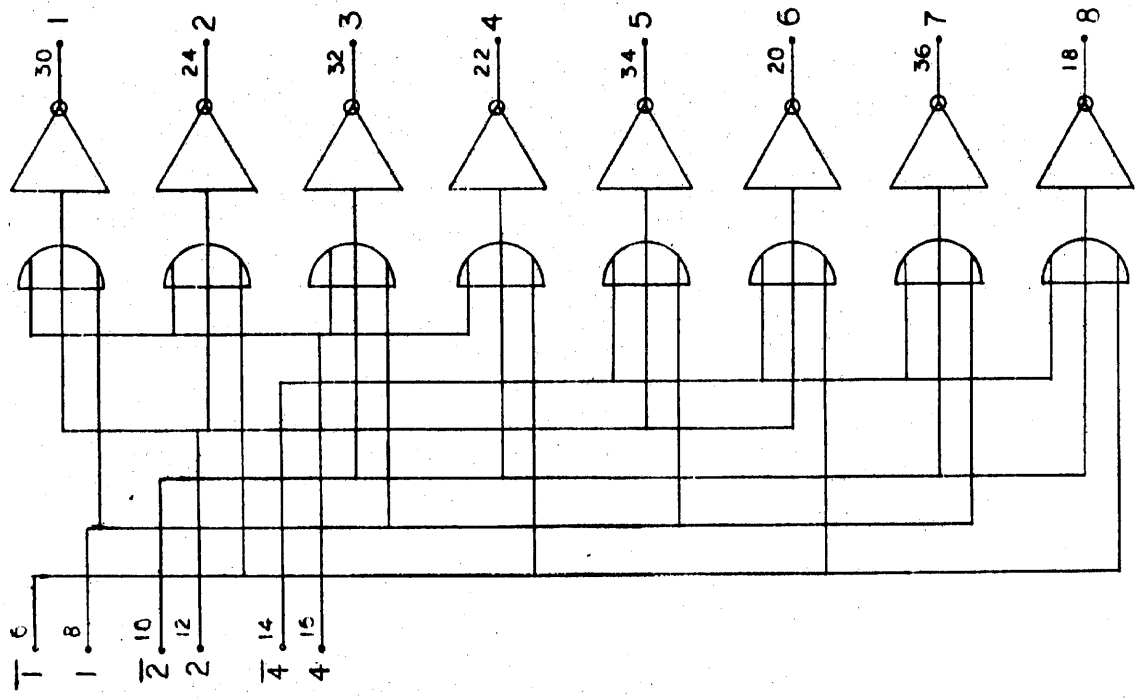

QK 52

Figure 48. Decoder and Selector Control Logic

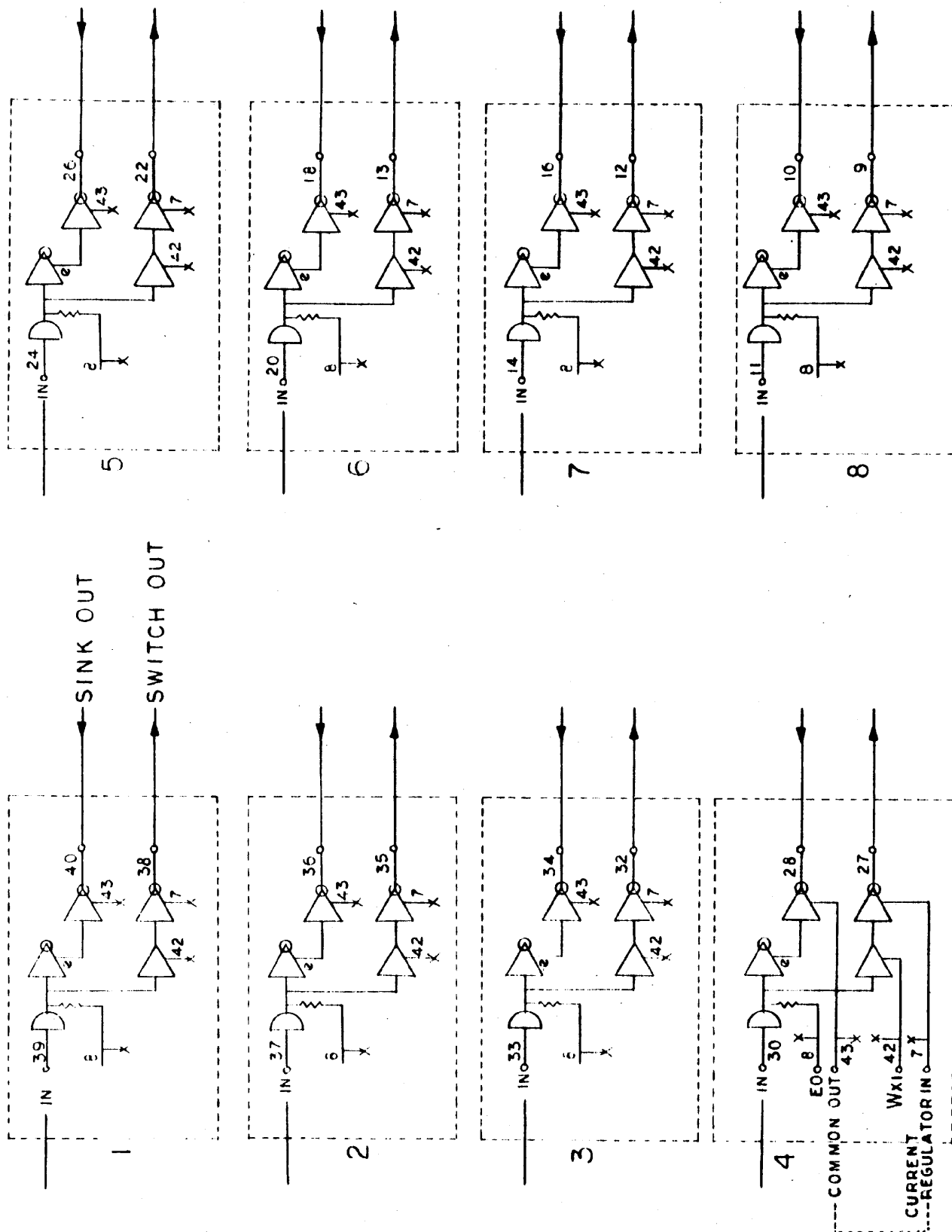

QK 53

Figure 49. X-Y Selector

## CURRENT REGULATOR

The current regulator module, designated SK58, contains three basic circuits, a voltage regulator, and two gated current stabilizers.

Pins 1, 2, 14, 16, and 18 are inputs to the voltage regulator which, in turn, controls the X and Y current stabilizers.

Pin 1 receives the +12 volt reference signal generated by the outputs of the SK53 and SK57 voltage regulators. This voltage will vary depending upon the amount of inhibit current desired. Pins 2 and 18 receive the +15 volt floating supply signal, which has a +12v. reference point. Pin 14 (control in) is used by the automatic "Start up/shut down" mechanism to inhibit all drive currents when the logical state of the computer is in an ambiguous area. Pin 16 (marginal test) is connected to the Marginal Test switch on the front panel of the computer and is used to increase or decrease the XY drive currents by approximately 6%. Pins 34 and 36 connect the Mrt (memory read timing) and Mwt (memory write timing), respectively. The read timing signal (Mrt) may be delayed and it, in turn, will delay the read current on the Y lines and, consequently, the sense signal.

The Mwt and Mrt signals gate the X and Y current stabilizers. Pins 20 and 22 are the current outputs for the X and Y switch circuits. Pins 9 and 10 are the current returns for the sink circuits. There is a potentiometer adjustment on the SK58 for varying the amount of XY drive current. This current is nominally about 500 ma, but should be adjusted according to the individual characteristics of each unit.

## VOLTAGE REGULATOR

The voltage regulator, designated SK53, generates a constant voltage of approximately + 12 v from the + 18 volt line from the power supply. The + 12 v output supplies the inhibit lines and serves as a reference signal to the current regulator module.

The SK57 voltage regulator module operates in parallel with the SK53 and receives its  $V_R$  control signal from the SK53. The threshold potentiometer on the SK57 is nominally set between 6 and 6.5 v, but is optimally adjusted according to the amount of noise on the sense lines. There is a potentiometer adjustment on the SK53 that determines the magnitude of the + 12 output which, in turn, determines the amount of current that will flow through the inhibit (Z) windings. This is nominally about 200 ma, but should be adjusted according to individual stack characteristics.

## Z DRIVER

The Z driver, designated HK52, drives the inhibit winding during the write cycle. The false output of the respective stage of the M (Memory) register is connected to the input. Depending upon the stack number, the input gate will be enabled by one of the stack selection digit signals D1, D2, D3, or D4.

During Mdt time, current will now flow through the inhibit winding.

## SENSE AMPLIFIER

The sense amplifier module, designated HK59, is composed of five basic sense amplifiers. The sense amplifier is basically a two-stage, balanced amplifier with

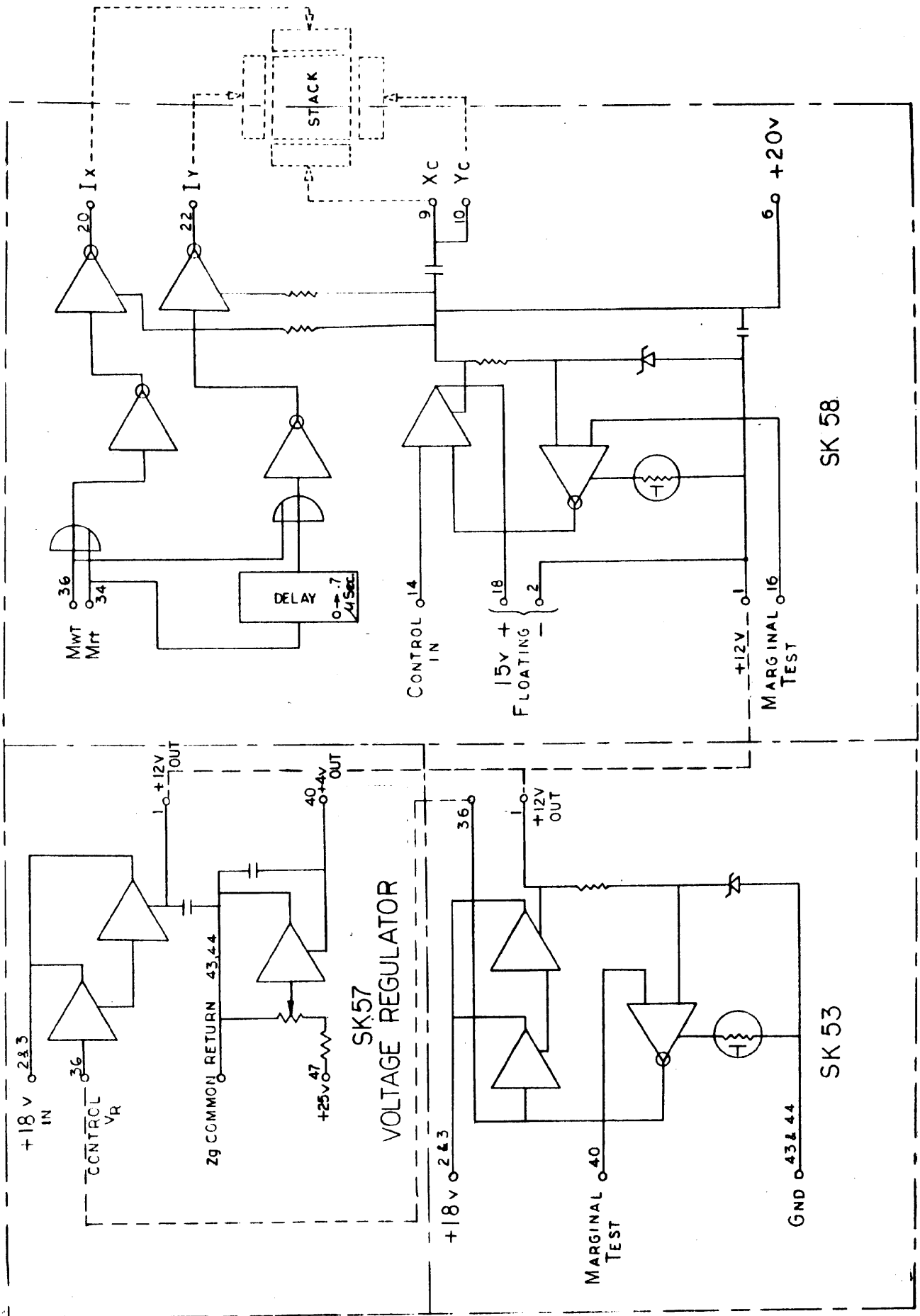

Figure 50. Voltage Regulator and Current Regulator

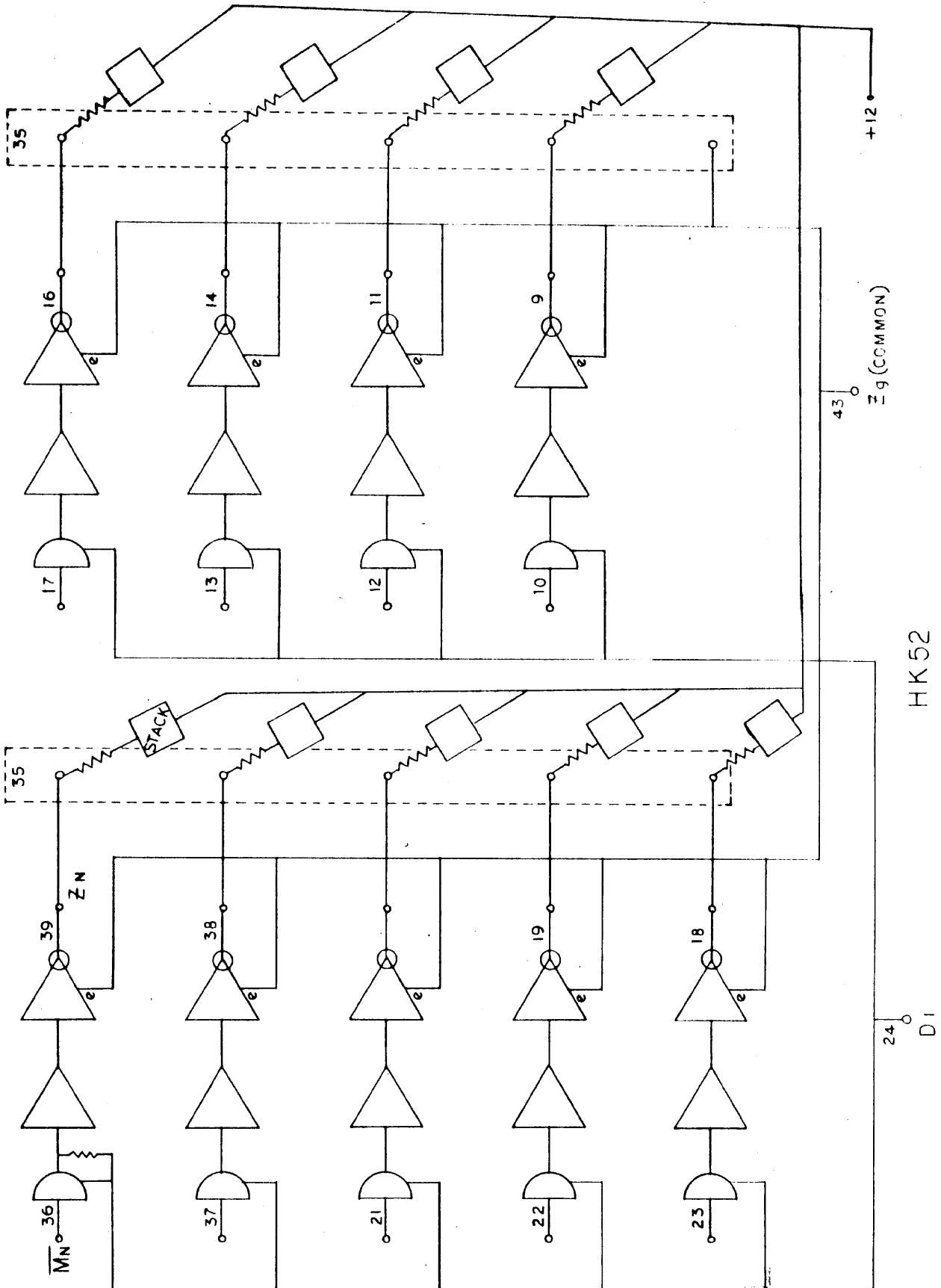
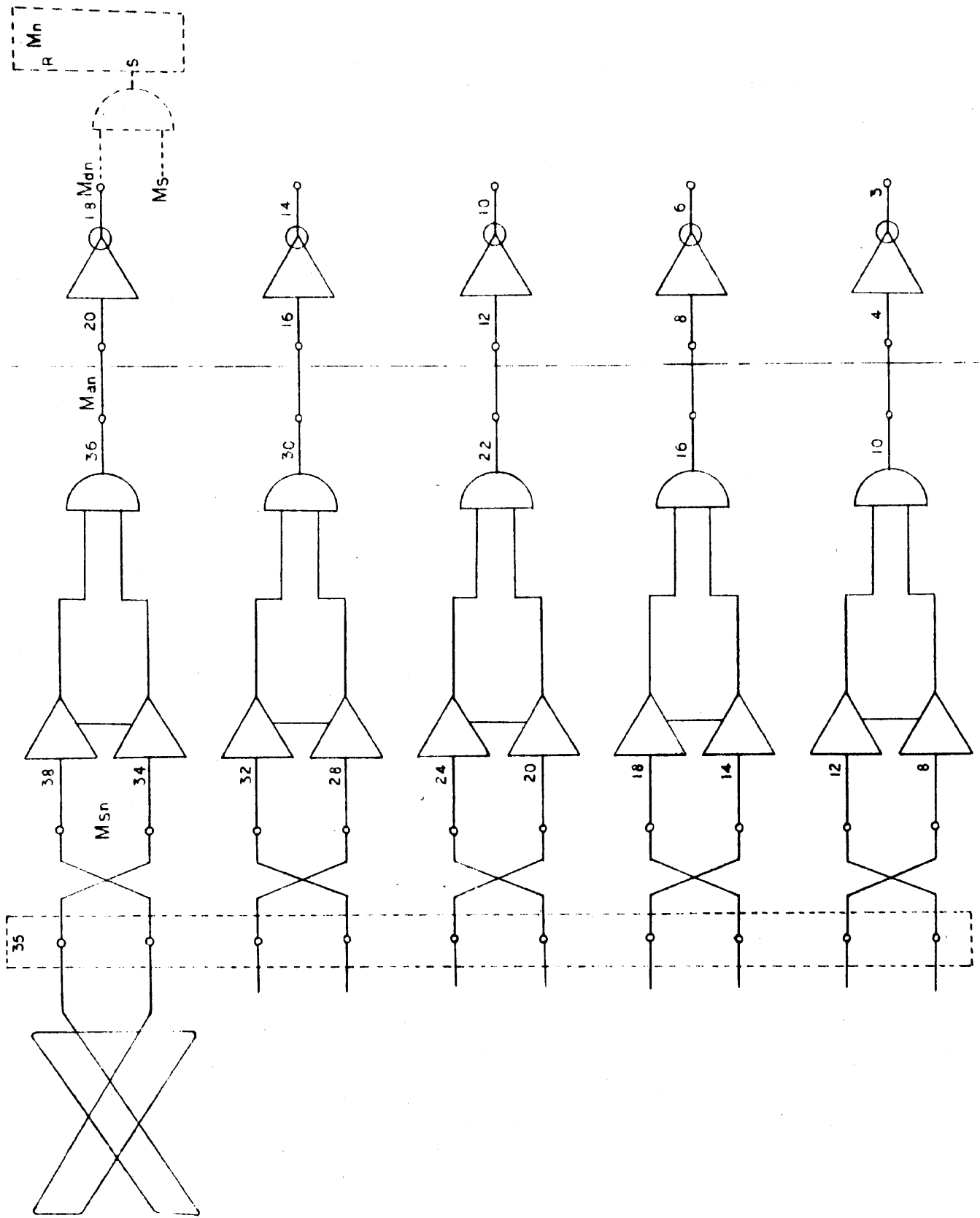

Figure 51. Z-Driver



HK 51

HK 59

Figure 52. Sense Amplifier and Discriminator Logic

SECTION IV

BCD TYPEWRITER AND TAPE PUNCH



## INTRODUCTION

This section contains the functional description and theory of operation of the Model 9134B BCD Typewriter and Tape Punch. Timing diagrams and logic equations are also included. The mechanical descriptions of this equipment are provided in the IBM and Tally manufacturers' manuals, which will constitute a part of the computer maintenance manual.

The information in this section should not be used for Model 9134A Tape Punch and/or Stretch Typewriter since both the punch and the typewriter are operated differently in the Model 9134A version. Use this section for the following model numbers:

<u>Model No.</u>	<u>Configuration</u>
9132B	Punch No. 1 plus coupler
9133B	Punch No. 2 plus coupler
9134B	Punch No. 1 and BCD Typewriter No. 1 plus coupler
9136	Spare Punch
9137B	BCD Typewriter No. 1 plus coupler
9138B	BCD Typewriter No. 2 plus coupler
9139B	BCD Typewriter spare

For proper use of this section, the reader should be familiar with the operation of the W Buffer for the SDS 910 or 920 Computer.

## BCD TYPEWRITER

### FUNCTIONAL DESCRIPTION

The typewriter is an IBM Selectric Input/Output Typewriter. It is used both for input and output. The type element or "golf ball" is special (#908). The typewriter is controlled by the typewriter/punch coupler chassis which is usually mounted in the computer rack. The coupler chassis plugs directly into the W or Y Buffer of the SDS 910 or 920 Computer. The coupler chassis contains an auxiliary connector socket which "repeats" the W or Y Buffer socket to which the coupler chassis is plugged.

Whenever the W or Y Buffer has been programmed to receive inputs from the typewriter, an indicator in the typewriter is lit. The operator can then type characters into the computer at a maximum rate of 15 characters per second. Each character typed sends a different six-bit code to the computer. A parity bit is also sent which is checked in the buffer.

All keys on the typewriter send a code with the exception of case shift. However, typing a key in lower case produces a different code from typing the same key in upper case.

Whenever the W or Y Buffer is programmed to output to the typewriter, the six-bit character codes sent from the computer will cause the typewriter to type at 15 characters per second. The typewriter will automatically case shift for those characters that require it; however, upper case characters are typed at only one-third the rate of lower case characters.

Following is a list of codes used on both input and output. Note that these correspond to the Hollerith codes which are standard for punched cards. All 64 combinations of six bits are used.

# TYPEWRITER CODES

<u>Character</u>	<u>Code</u>	<u>Character</u>	<u>Code</u>
Ø	00	-	40
1	01	J	41
2	02	K	42
3	03	L	43
4	04	M	44
5	05	N	45
6	06	O	46
7	07	P	47
8	10	Q	50
9	11	R	51
SPACE	12	CAR. RET.	52
# or =	13	\$	53
@ or ' }	14	*	54
:	15		55
>	16	;	56
√	17	Δ	57
& or +	20	ḃ	60
A	21	/	61
B	22	S	62
C	23	T	63
D	24	U	64
E	25	V	65
F	26	W	66
G	27	X	67
H	30	Y	70
I	31	Z	71
BACK SPACE	32	TAB	72
.	33	,	73
Π or )	34	% or (	74
[	35	~	75
<	36	\	76
‡	37	*	77

\* Upper Case Character

## THEORY OF OPERATION - INPUT (from typewriter to computer)

When the W or Y Buffer contains an address that calls for a typewriter input or output, an amplifier in the coupler chassis goes true.

$$T_e = \overline{W10} \overline{W11} \overline{W12} \overline{W13} W14$$

This typewriter "enable" signal is gated into the pertinent logic of the coupler. If more than one typewriter is tied to the same computer buffer, then each typewriter must have its own coupler chassis and the second and third typewriters must have different "enable" addresses.

$$\text{For No. 2} \quad T_e = \overline{W10} \overline{W11} \overline{W12} W13 \overline{W14}$$

$$\text{For No. 3} \quad T_e = \overline{W10} \overline{W11} \overline{W12} W13 W14$$

Changing the address requires a minor wiring modification; diodes in the coupler chassis are left free for this purpose. For inputs, the typewriter indicator is lit.

$$T_{lt} = T_e \overline{W9} \overline{W5}$$

The Tlt solenoid driver drives the 8-volt light.

When a character is typed, the G20 one-shot is triggered. It resets about 20 milliseconds later,

$$sG20 = T_e \overline{W5} \overline{G30} \overline{G50} (\textcircled{T_c} \overline{W9} + \overline{T_c} \textcircled{E_c} W9) \underline{Q2} + \dots$$

where  $\textcircled{T_c}$  is a "common" signal from the typewriter indicating that a character was typed.

As soon as G20 is set, the G30 one-shot is triggered.

$$sG30 = G20 (\overline{U_k} + \overline{Dt}) \underline{Q2}$$

This thirty-millisecond one-shot stays on ten milliseconds longer than G20. This ten milliseconds (G20 G30) provides a "window" when the computer samples the typewriter contacts to properly determine the character. The flip-flop Dt is set,

$$sDt = T_e \overline{G20} \overline{G30} \overline{G50} (\overline{Sh} + U_k) \underline{Q2} \overline{Dt}$$

where  $\overline{Sh}$  is always true during inputs.

This flip-flop allows the G50 one-shot to trigger.

$$sG50 = G30 \overline{G20} (Dt \overline{W14} + \dots) Q2$$

The flip-flop Dt clocks the W or Y Buffer which, in turn, opens the gates that allow the character to be transferred from the typewriter contacts into the W or Y Buffer.

$$\overline{E_{cw}} = \overline{(Dt \overline{Uk} G50)}$$

(Uk is always reset during inputs.)

All character decoding is done in the typewriter itself, using diodes where necessary. The complete input circuit for one bit is shown below:

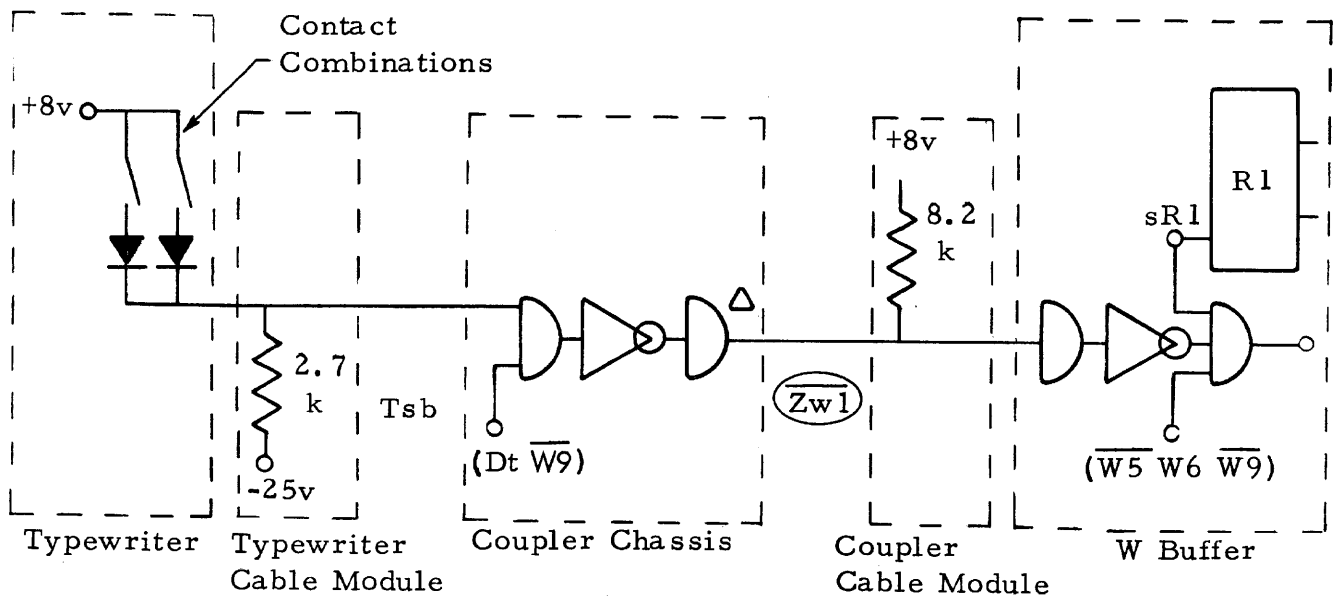

$$\overline{Zw1} = \overline{(Dt \overline{W9} Tsb)} \quad (\text{as shown})$$

$$\overline{Zw2} = \overline{(Dt \overline{W9} Tsa)}$$

$$\overline{Zw3} = \overline{(Dt \overline{W9} Ts8)}$$

$$\overline{Zwp} = \overline{(Dt \overline{W9} Tsc)} \quad (\text{odd parity from typewriter})$$

The character is transferred until G30 relaxes and Dt is reset.

$$rDt = G50 \overline{G30} \overline{Uk} \underline{Q2} + \dots$$

The logic will not accept another character until G50 is reset since  $\overline{G50}$  is included in the sG20 input gate.

## THEORY OF OPERATION - OUTPUT (from computer to typewriter)

The same one-shots used for input are also used for output. When the W Buffer addresses the typewriter for output (Te W9) and there is a character in the buffer's character register ( $\overline{W5}$ ), the typewriter logic begins its output cycle as soon as the typewriter is ready,

$$sG20 = Te \overline{W5} \overline{G30} \overline{G50} \overline{Tc} \textcircled{Ec} W9 \underline{Q2} + - - -$$

where  $\overline{Tc}$  is the inverse of the  $\textcircled{Tc}$  common contact and requires the typewriter not to be in the process of typing.  $\textcircled{Ec}$  is the tabulate and carriage return interlock signal that inhibits the above gate if the typewriter is performing a tabulate (tab), carriage return, space, or backspace.

$$\textcircled{Tc} = (C2)$$

$$\textcircled{Ec} = (\overline{C1}) (\overline{C5}) (\overline{C6}) (\overline{\text{tab interlock}}) (\overline{\text{C.R. interlock}})$$

Consider an output where the automatic case shift is not required. The Sh (shift) amplifier is true for case shift characters and false for lower case characters.

$$Sh = W9 R3 R4 + W9 R1 R3 \overline{R4} R5 \overline{R6}$$

The first term is for case-shift print characters and the second term is for carriage return and tab which will be described later.

For lower case character outputs, Sh is false so that the Uk (upper case) flip-flop is never set.

After G20 is set, G30 is set,

$$sG30 = G20 (\overline{Uk} + \overline{Dt}) \underline{Q2}$$

and when G20 resets, Dt is set.

$$sDt = Te \overline{G20} G30 \overline{G50} (\overline{Sh} + Uk) \underline{Q2} \overline{Dt}$$

Dt causes G50 to trigger.

$$sG50 = G30 \overline{G20} (D + W14 + - - -) \underline{Q2}$$

When G30 relaxes, Dt is reset.

$$rDt = G50 \overline{G30} \overline{Uk} \underline{Q2} + - - -$$

While G20 is set, the print solenoid control amplifier goes true if it is a print character.

$$Td = Te W9 G20 \overline{Tc} (Uk + \overline{Sh}) \overline{Dt} (\overline{R3} + R4 + \overline{R5} + R6) (R1 + R2 + R3 + R4 + R5 + R6 + Rp)$$

$\overline{Tc}$  is in this gate to stop current to the print solenoids as soon as the "common" closes. This is recommended by the manufacturer. ( $\overline{R3 + R4 + R5 + R6}$ ) defines the character as a print rather than a function character. Function characters are space, back space, tab and carriage return.

( $R1 + R2 + R3 + R4 + R5 + R6 + Rp$ ) is in the gate so that the typewriter will not type a "Ø" if the programmer should address the W Buffer and ask for "leader". If he does ask for leader, an extra type cycle time is wasted but nothing is typed.

The Td amplifier gates all the seven print solenoid drivers. The solenoid drivers actuate the solenoids to print the proper character. One solenoid is used as a common and is actuated for every print cycle.

$$Tdp = Td$$

$$Td40 = Td \overline{R1} \overline{R2} + Td R1 R2$$

$$Td20 = Td \overline{R2}$$

$$Td10 = Td \overline{R3}$$

$$Td4 = Td \overline{R3} \overline{R4}$$

$$Td2 = Td \overline{R5}$$

$$Td1 = Td \overline{R3} R6 + Td R3 \overline{R6}$$

The above logic translates the character from the SDS code to the typewriter code.

The Dt flip-flop clocks the buffer so that the next character will be placed in the W Buffer character register. However, this new character cannot be typed until the common contact has opened and the G50 one-shot has relaxed. Note that the clock (Dt) occurs after the character has already been driven into the typewriter solenoids.

The functions, space and back space, have exactly the same control logic and timing as lower case print characters. However, the print solenoid control amplifier is inhibited and, instead, the function solenoid control amplifier goes true.

$$Tf = Te W9 R3 \overline{R4} R5 \overline{R6} G20 \overline{Uk} \overline{Dt} \overline{Tc}$$

Here  $R3 \overline{R4} R5 \overline{R6}$  is the partial code for all functions;  $\overline{Tc}$  again is the inverse of the common contact and stops the solenoid current as soon as the common contact closes.

Tf then allows the proper function solenoid to operate.

$$T_{dbs} = T_f \overline{R1} R2 \quad (\text{back space})$$

$$T_{dsp} = T_f \overline{R1} \overline{R2} \quad (\text{space})$$

### Upper Case Character Outputs

It takes three times as long to print an upper case character because the one-shots go through three complete cycles. Basically, the first cycle puts the typewriter in upper case, the second cycle prints the character, and the third cycle allows the typewriter to return to lower case. The Sh amplifier goes true as soon as the upper case character code is in the W Buffer character register.

$$Sh = Te W9 R3 R4 + - - -$$

All upper case codes have R3 R4 true. Sh stays true during the whole operation and controls the timing. During the operation two flip-flops, Dt and Uk, form a particular type of counter. Their configurations can best be seen from the timing diagram or analyzed from the logic equations. Uk is set after G20 relaxes on the first one-shot cycle. Uk remains set until G20 is set again on the third one-shot cycle. It therefore is set approximately 50 milliseconds before the print cycle, which is the second one-shot cycle, and remains set until this second cycle is complete. It remains reset during the third cycle. For lower case outputs Dt is high for each one-shot cycle during the time that G20 is low and G30 is still high.

For upper case outputs, Dt remains low during the first one-shot cycle. On the second one-shot cycle, Dt is set after G20 relaxes and remains high until after G30 relaxes in the third one-shot cycle. Therefore, Dt comes high at about the time the next character appears in the R1-R6 flip-flops. If the character is upper case, then  $\overline{Dt}$  will remain high until G20 relaxes in the middle one-shot cycle. Also,  $\overline{Dt}$  controls the upper case solenoid driver. The typewriter should not lock in upper case but is held there only by the solenoid, since the mechanical latch is disabled.

$$T_{duc} = Sh \overline{Dt} R4 Te$$

During G20 of the second one-shot cycle, the print solenoid control amplifier goes true and opens the gates to the print solenoids. The same logic is used to translate the codes to the typewriter. Sixteen upper case characters are used.

### Tab and Carriage Return Outputs

When operating either a tab or carriage return function, the Sh amplifier is held true as for upper case characters.

$$Sh = W9 R1 R3 \overline{R4} R5 \overline{R6} + - - -$$

This causes the one-shots to go through three complete cycles exactly as they do for an upper case character. However, the function solenoid control amplifier goes true during G20 of the



first one-shot cycle and the second two cycle times are "dummies". These two dummy cycles allow for sloppy timing of the opening and closing of the tab and carriage return interlock contacts. The interlock contact stops the next one-shot cycle whenever it closes. If it closes too late, a dummy cycle is used as the carriage begins to return (instead of typing the next character).

If the contact opens too soon when the carrier hits the left margin, another dummy character cycle is used (instead of typing the next character to the left of the actual margin). If the contact is timed perfectly, two type cycle times are wasted after the tab or carriage return, but this is a small percentage of the tab or carriage return time. If the tab or carriage return is the last character typed before the buffer is to be used for another device, then these dummy cycles normally tie up the buffer during the entire carriage return or tab. The function solenoid control amplifier is true during G20 of the first cycle and gates the proper solenoid driver.

$$T_f = T_e W_9 R_3 \overline{R_4} R_5 \overline{R_6} G_{20} \overline{U_k} \overline{D_t} \overline{T_c}$$

$$T_{dtb} = T_f R_1 R_2 \quad (\text{tab})$$

$$T_{dcr} = T_f R_1 \overline{R_2} \quad (\text{carriage return})$$

For these three-cycle operations, the buffer clock is not sent until the  $\overline{G_{20}} G_{30}$  time of the last one-shot cycle.

$$\overline{E_{cw}} = (\overline{D_t} \overline{U_k} G_{50})$$

## ADJUSTMENTS

### One-Shot timing

The following times are recommended for one-shot settings:

G20 for 25 milliseconds

G30 for 45 milliseconds

G50 for at least 35 milliseconds, and adjusted on  
timeout to provide minimum "jitter" of  $T_c$

With the total G20-G50 cycle set at 60 ms and with  $E_c$  controlled by C1, C5, and C6 the output typing rate is controlled by feedback from the typewriter. Cam C1 controls for normal lower case characters. Cam C5 controls for tab, space, and backspace. Cam C6 controls the feedback for carriage returns.

The typewriter solenoids which are controlled by G20 should have at least 18 milliseconds and preferably longer. However, the upper case solenoid should be actuated at least 40 milliseconds before the print solenoids are actuated - this is determined by G50.

An important mechanical consideration is to make the shift to upper case while the character positioning operation is stable so that the two motions will not be additive. See figure 55.

The typewriter will print if any of the seven print solenoids are actuated. When the solenoids are actuated manually, one at a time, the following characters should be typed: F, . \$ I F &. If extra periods are typed (period is the character typed if no solenoid actuates but the print cycle actuates erroneously), then the turnbuckle on the trip link near the print solenoids might need adjusting.

If the typewriter refuses to output, it is possible that the tab or carriage return interlock contact is not actuating.

Information about the typewriter itself can be obtained from the IBM/input/output customer service manual which will be a part of the computer maintenance manual. For repairing the mechanical part of the typewriter it is advisable to call an IBM serviceman, preferably one who has had training on the Selectric input/output typewriter.

### Timing Diagrams

The timing diagrams for typewriter input and output are shown on the following pages.

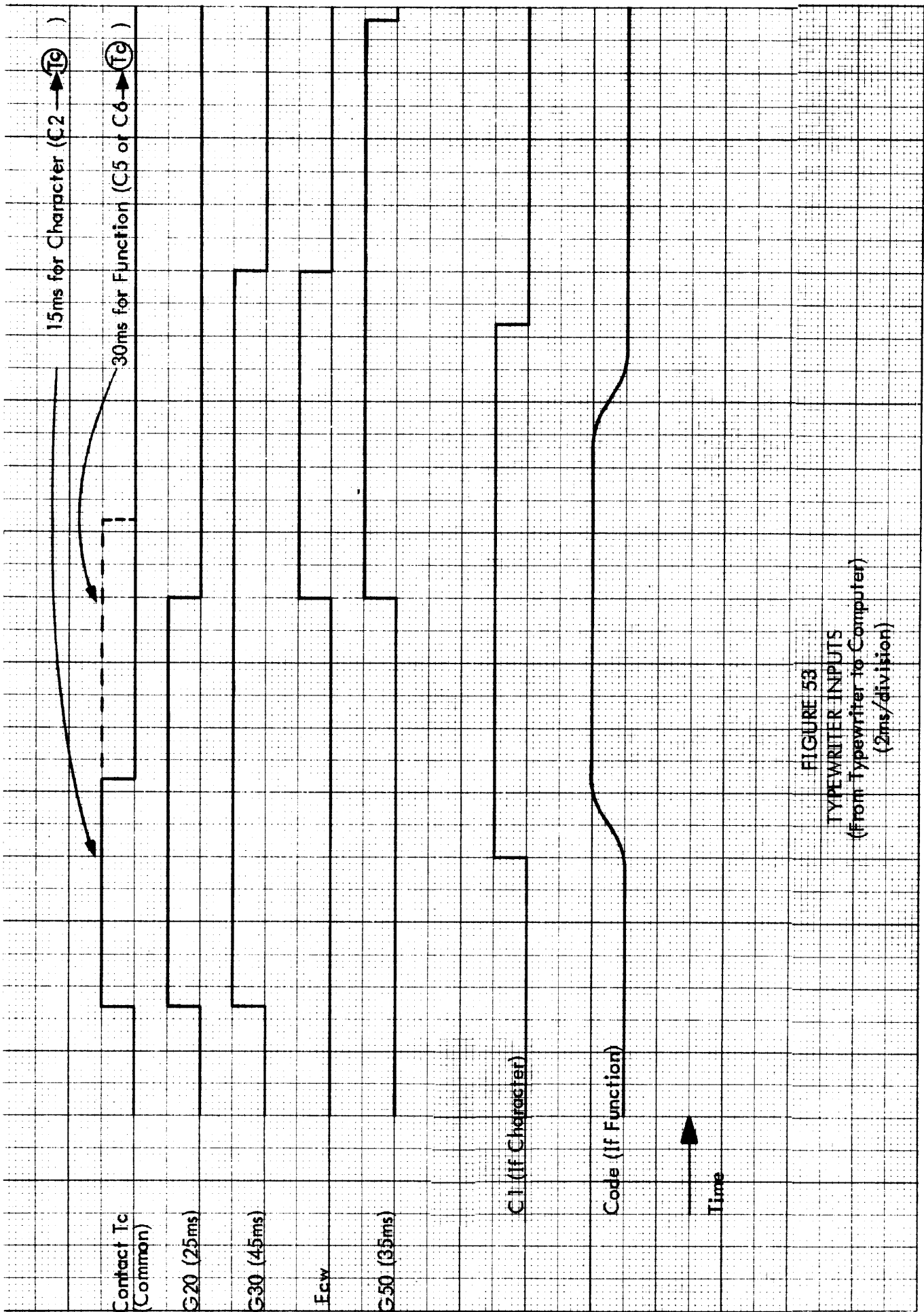

FIGURE 53  
 TYPEWRITER INPUTS  
 (From Typewriter to Computer)  
 (2ms/division)

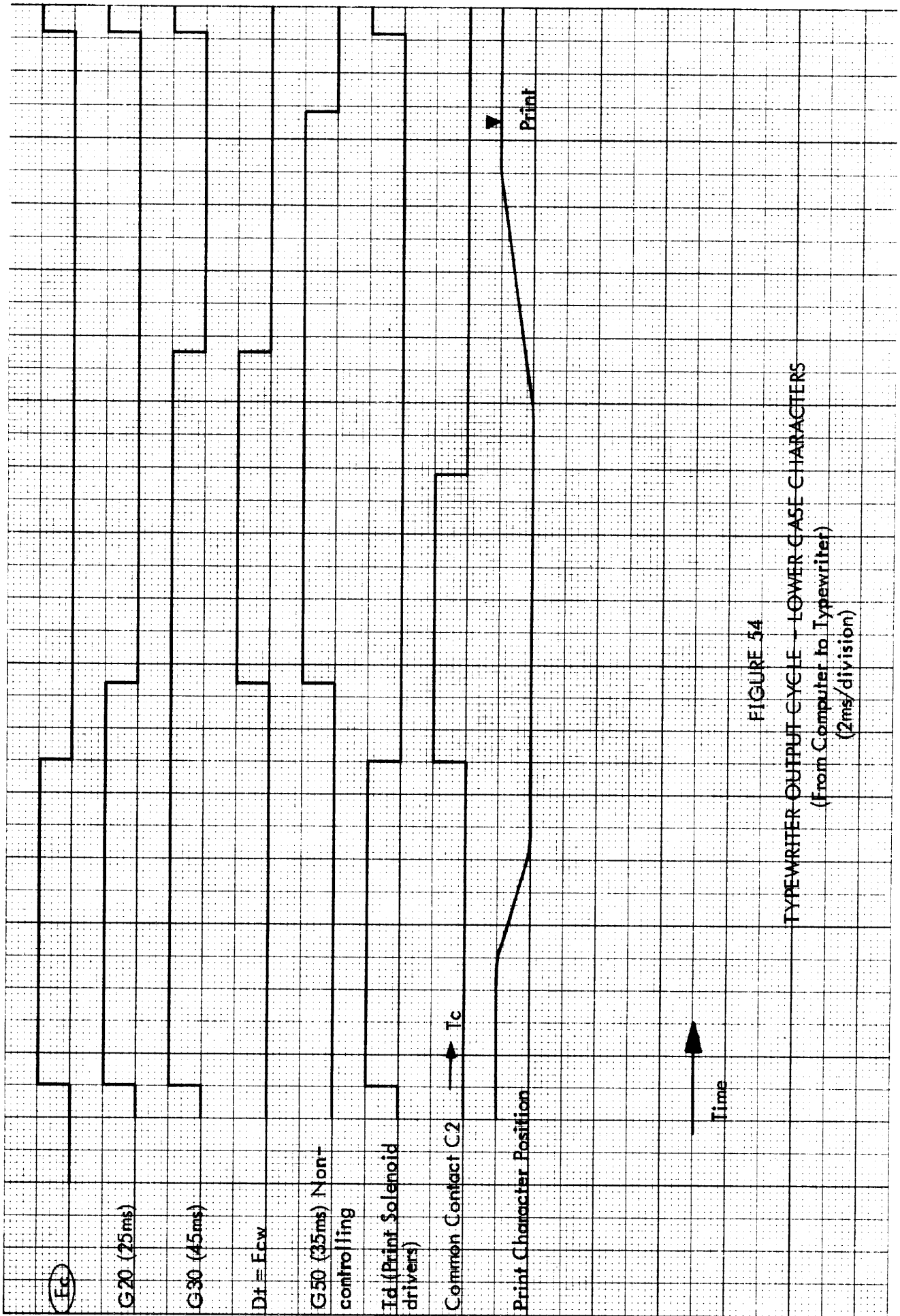

FIGURE 54  
 TYPEWRITER OUTPUT CYCLE - LOWER CASE CHARACTERS  
 (From Computer to Typewriter)  
 (2ms/division)

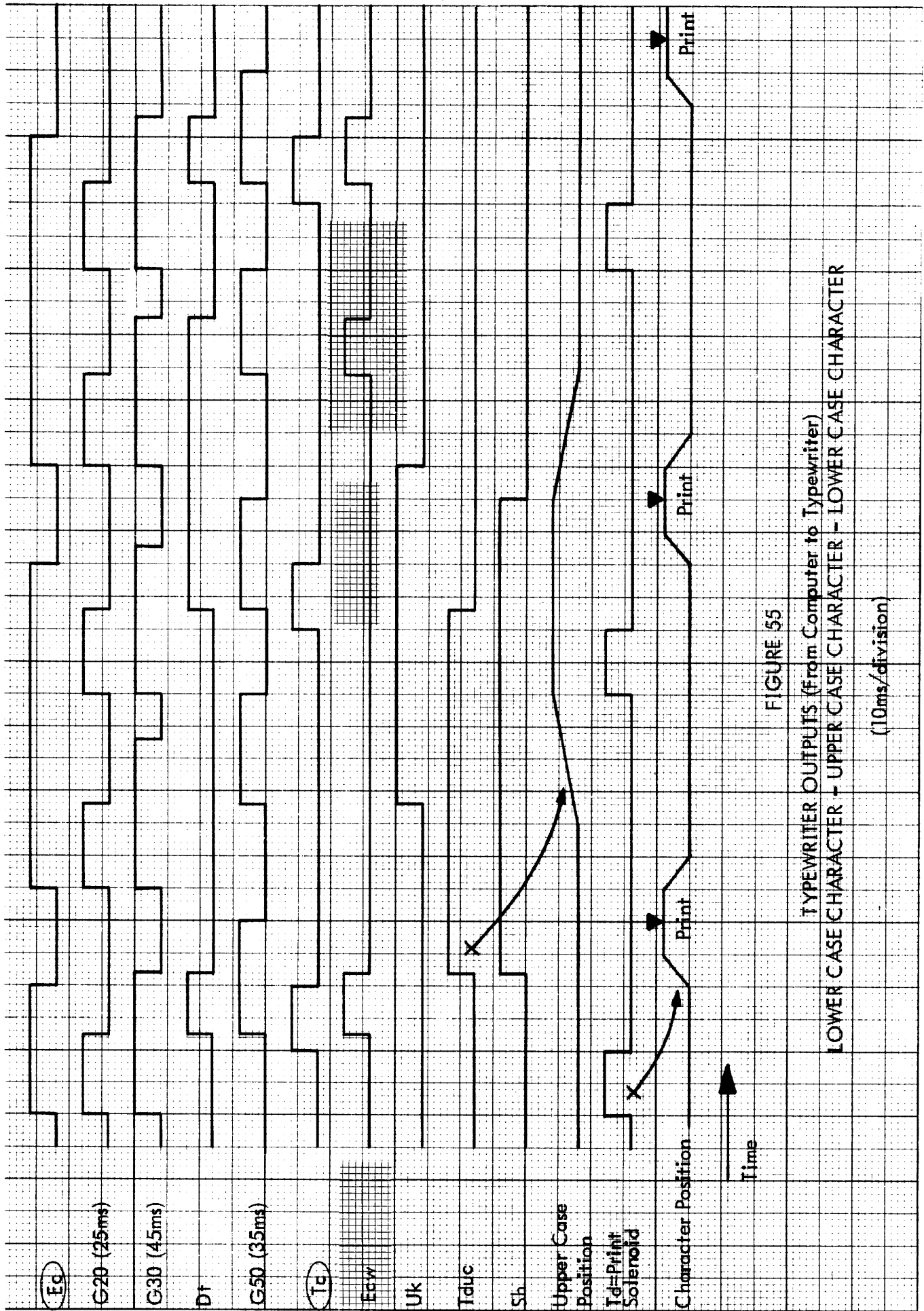

FIGURE 55

TYPEWRITER OUTPUTS (From Computer to Typewriter)  
 LOWER CASE CHARACTER - UPPER CASE CHARACTER - LOWER CASE CHARACTER

(10ms/division)

## DICTIONARY OF BCD TYPEWRITER LOGIC TERMS

- Dt A control flip-flop used on both outputs and inputs. It normally times the buffer clock.
- (Ec) The carriage return and tabulate interlock contact signal. It is false during the operation of a tabulate or carriage return.
- (E<sub>cw</sub>) Clock to the W Buffer.
- G20 A one-shot that determines duration of solenoid current on outputs and blanks out erroneous signals during inputs.
- G30 A one-shot that is fired immediately after G20 is fired. It is also used by the tape punch logic.
- G50 A one-shot that provides delay between output characters.
- R1-R6, Rp The character register of the W Buffer.
- Sh An amplifier that is true for outputs on upper case characters, tabulate and carriage return.
- (Tc) The typewriter "common" contact signal that goes true when a key is typed.
- Td An amplifier that controls the print solenoid drivers.
- Td40-Td1 Output of six coded print solenoid drivers.
- Tdbs Back space solenoid driver.
- Tdcr Carriage Return solenoid driver.
- Tdp The output of the "common" print solenoid driver.
- Tdsp Space solenoid driver.
- Tdtb Tabulate solenoid driver.
- Tduc Upper case solenoid driver.
- Te Typewriter "enable" amplifier. Allows typewriter logic to function.
- Tf An amplifier that controls the function solenoid drivers (space, back space, tabulate, carriage return).

Tlt	Light solenoid driver. Drives light in typewriter indicating an input request.
Tsb	Six coded signals from typewriter to coupler logic which carry the character code on inputs.
Tsa	
Ts8	
Ts4	
Ts2	
Ts1	
Tsc	Parity signal from typewriter to coupler logic.
Uk	A flip-flop used on upper case outputs and on tabulate and carriage return outputs.
W5	Flip-flop in W Buffer.
W9-W14	Flip-flops in W Buffer.
$\overline{Zw1}$ - $\overline{Zw6}$	Data Inputs to W Buffer.
$\overline{Zwp}$	Parity bit to W Buffer.

## BCD TYPEWRITER LOGIC EQUATIONS

### Enable

$$T_e = \overline{W10} \overline{W11} \overline{W12} \overline{W13} W14$$

### Timing

$$G20 = T_e \overline{W5} \overline{G30} \overline{G50} (\overline{T_c} \overline{W9} + \overline{T_c} \overline{E_c} W9) \underline{Q2} + \dots$$

$$G30 = G20 (\overline{U_k} + \overline{D_t}) \underline{Q2}$$

$$G50 = G30 \overline{G20} (D_t W14 + Sh \overline{U_k} + Pe G30) \underline{Q2}$$

### Control

$$sD_t = T_e \overline{G20} G30 \overline{G50} (\overline{Sh} + U_k) \underline{Q2} \overline{D_t}$$

$$rD_t = G50 \overline{G30} \overline{U_k} \underline{Q2} + \overline{T_e} \underline{Q2} D_t$$

$$sU_k = T_e Sh G30 G50 \overline{D_t} \underline{Q2} \overline{U_k}$$

$$rU_k = G20 D_t \underline{Q2} + \overline{T_e} \underline{Q2} U_k$$

$$Sh = W9 R3 R4 + R1 W9 R3 \overline{R4} R5 \overline{R6}$$

### Solenoid Control

$$T_d = T_e W9 G20 \overline{T_c} (U_k + \overline{Sh}) \overline{D_t} (\overline{R3} + R4 + \overline{R5} + R6)(R1 + R2 + R3 + R4 + R5 + R6 + R_p)$$

$$T_f = T_e W9 R3 \overline{R4} R5 \overline{R6} G20 \overline{U_k} \overline{D_t} \overline{T_c}$$

### Print Solenoid Drivers

$$T_{dp} = T_d$$

$$T_{d40} = T_d \overline{R1} \overline{R2} + T_d R1 R2$$

$$T_{d20} = T_d \overline{R2}$$

$$T_{d10} = T_d \overline{R3}$$

$$T_{d4} = T_d \overline{R3} \overline{R4}$$

$$T_{d2} = T_d \overline{R5}$$

$$T_{d1} = T_d \overline{R3} R6 + T_d R3 \overline{R6}$$



### Function Solenoid Drivers

$$Tduc = Sh \overline{Dt} R4 Te$$

$$Tdbs = Tf \overline{R1} R2$$

$$Tdsp = Tf \overline{R1} \overline{R2}$$

$$Tdtb = Tf R1 R2$$

$$Tdcr = Tf R1 \overline{R2}$$

### Light Driver

$$Tlt = Te \overline{W9} \overline{W5}$$

### Clock

$$\overline{Ecw} = \overline{(Dt \overline{Uk} G50 W14)}$$

$$\textcircled{Ec} = \overline{(C1) (C5) (C6) (Tab Interlock) (CR Interlock)}$$

### Inputs

$$\textcircled{\overline{Zw1}} = \overline{(Dt \overline{W9} Tsb)}$$

$$\textcircled{\overline{Zw2}} = \overline{(Dt \overline{W9} Tsa)}$$

$$\textcircled{\overline{Zw3}} = \overline{(Dt \overline{W9} Ts8)}$$

$$\textcircled{\overline{Zw4}} = \overline{(Dt \overline{W9} Ts4)}$$

$$\textcircled{\overline{Zw5}} = \overline{(Dt \overline{W9} Ts2)}$$

$$\textcircled{\overline{Zw6}} = \overline{(Dt \overline{W9} Ts1)}$$

$$\textcircled{\overline{Zwp}} = \overline{(Dt \overline{W9} Tsc)}$$

## TAPE PUNCH

### FUNCTIONAL DESCRIPTION

The tape punch for the 900 Series Computers punches paper or mylar tape at a rate of 60 characters per second. A character is composed of six bits plus an odd parity bit. One-inch tape is generally used.

The punch is controlled by the punch/typewriter coupler chassis which is usually mounted inside the computer rack. The coupler chassis plugs directly into the W or Y Buffer of the SDS 910 or 920 Computer.

"Leader" is punched and fed by depressing a button on the punch panel. The "leader" has only sprocket holes punched. A toggle switch can be set in either the "auto" or "run" position. If it is placed in the "run" position, the punch motor runs continuously. If it is placed in the "auto" position, the punch motor is turned on only when the W Buffer has addressed the punch or the feed button has been manually depressed. When the switch is in the "auto" position, there is an automatic delay each time the buffer addresses the punch in order to allow the motor to get up to speed.

### THEORY OF OPERATION

#### Tape Feed (See Figure 56)

When the feed button on the punch is manually depressed, the signal,  $\textcircled{Ksp}$ , goes true.  $\textcircled{Ksp}$  "enables" the punch motor relay driver. The relay driver closes a relay in the punch assembly which, in turn, closes the ac circuit to the punch motor.

$$Pd = \textcircled{Ksp} + \dots$$

A 200 millisecond one-shot is triggered which provides a delay to allow the motor to get up to speed. Also, a 4.5 millisecond one-shot is triggered which sets the Dp flip-flop.

$$sD200 = \textcircled{Ksp} \overline{Fd} \overline{Dp} \underline{Q2} + \dots$$

$$sD4.5 = \textcircled{Ksp} \overline{D12} \overline{Dp} \overline{G30} \underline{Q2} + \dots$$

$$sDp = D4.5 \overline{D12} \underline{Q2} \overline{Dp}$$

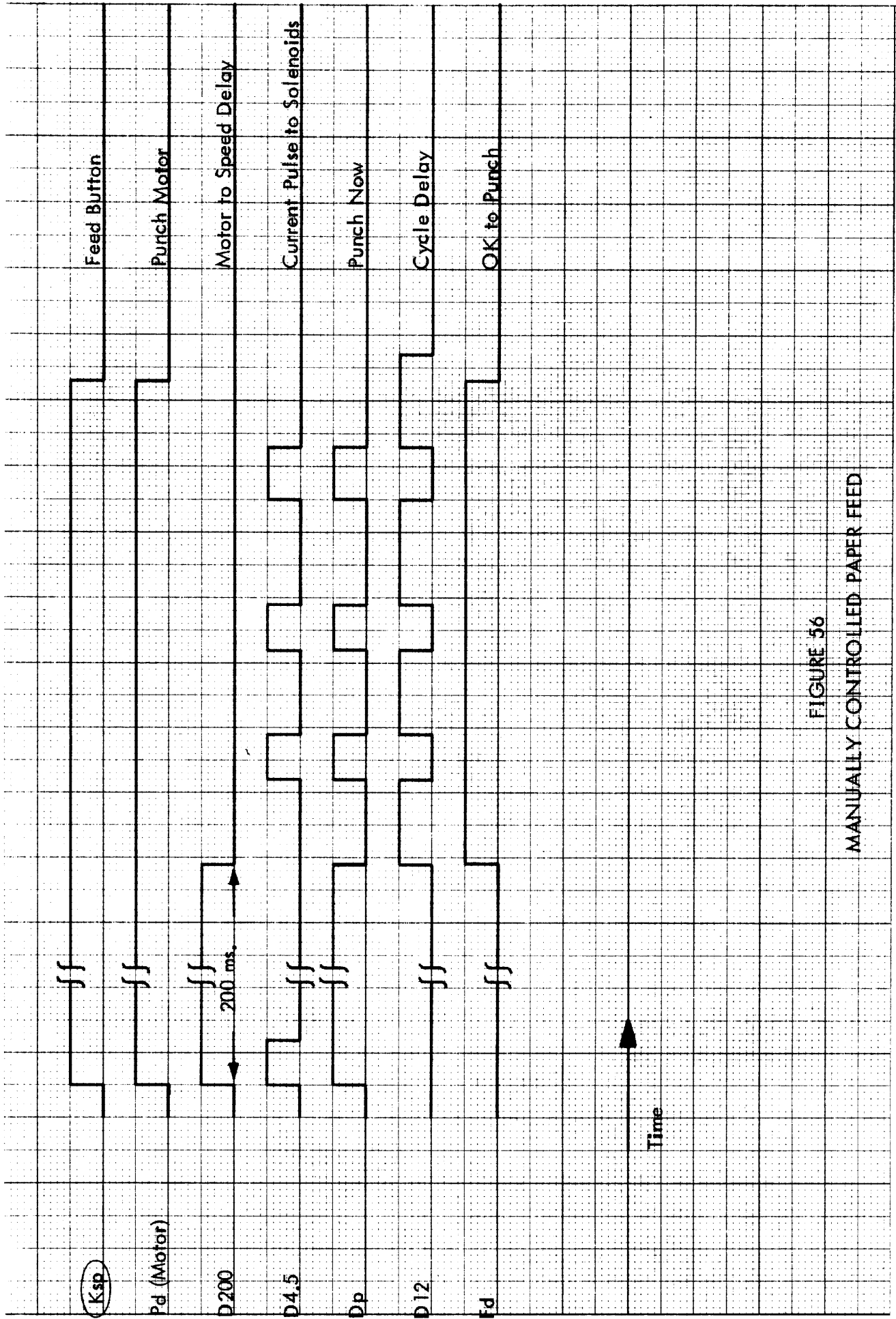

FIGURE 56  
MANUALLY CONTROLLED PAPER FEED

The Dp flip-flop stays set for the duration of the 200 millisecond one-shot. When D200 relaxes, a twelve-millisecond one-shot is fired. This one-shot allows the Fd flip-flop to be set and the tape feed process to begin.

$$sD12 = Dp \overline{D4.5} (\overline{D200} + Fd) \underline{Q2}$$

$$sFd = D12 Dp \underline{Q2} + - - -$$

$$rDp = D12 \underline{Q2} Dp$$

With the Fd flip-flop set, the D4.5 and D12 one-shots and the Dp flip-flop form a counter and provide pulses to drive the punch.

$$sD4.5 = (\text{Ksp}) \overline{D12} \overline{Dp} \overline{G30} \underline{Q2} + - - -$$

$$sDp = D4.5 \overline{D12} \underline{Q2} \overline{Dp}$$

$$rDp = D12 \underline{Q2} Dp$$

$$sD12 = Dp \overline{D4.5} (\overline{D200} + Fd) \underline{Q2}$$

The sprocket solenoid driver and then the feed solenoid driver are actuated. The feed solenoid is timed by the punch to feed after all punches are clear and before the next punch occurs. The process repeats and tape leader is generated as long as the button remains depressed.

$$Pf = Fd Dp \quad (\text{feed solenoid driver})$$

$$Psp = Fd Dp \quad (\text{sprocket solenoid driver})$$

The data channel solenoid drivers are inhibited. If the feed button is pressed while the buffer is addressing the punch, an input/output parity error may occur because the Dp flip-flop will clock the buffer before a character is in the buffer's character register. If the typewriter is tied to the buffer during the tape feed operation, the typewriter G30 one-shot will inhibit D4.5 and temporarily interrupt the tape feed but will cause no difficulty.

#### Data Punching (See Figure 57.)

When the W (or Y) Buffer addresses the punch, a punch enable amplifier, Pe, goes true.

$$Pe = W9 \overline{W10} \overline{W11} W12 \overline{W13} \overline{W14}$$

If there is a second punch connected to the same buffer, then each punch must have its own coupler chassis and the second punch chassis must have a minor wiring modification so that:

(Punch No. 2)  $Pe = W9 \overline{W10} \overline{W11} W12 \overline{W13} W14$

Diodes in the coupler are available for this modification. The punch logic must accommodate three different situations to start punching data. They will be described in order.

1. The program asks for leader.

When the buffer addresses the punch,  $Pe$  goes true which allows the  $Pd$  solenoid driver to close the relay that applies ac voltage to the punch motor. This procedure occurs regardless of the position of the "run-auto" toggle switch.

Since leader was asked for,  $W5$  is false and the  $D200$  one-shot fires immediately.

$$sD200 = Pe \overline{W5} \overline{Fd} \overline{Dp} \underline{Q2} + - - -$$

The  $D4.5$  one-shot also fires for 4.5 milliseconds and allows the  $Dp$  flip-flop to set.

$$sDp = D4.5 \overline{D12} \underline{Q2} \overline{Dp}$$

The  $D12$  one-shot is inhibited until the  $D200$  one-shot relaxes, at which time the punch motor should be up to speed.  $D12$  fires at the first  $\underline{Q2}$  pulse after  $D200$  relaxes, and at the following  $\underline{Q2}$  clock,  $Fd$  is set and  $Dp$  is reset.

$$sFd = D12 Dp \underline{Q2} + - - -$$

$$rDp = D12 \underline{Q2} Dp$$

The motor is now up to speed and the punch is now ready to punch some leader. The  $D200$  one-shot is also used to time the punching of leader but since  $D200$  just relaxed, it is not ready to properly trigger again until its "dead time" has elapsed. This time delay is provided by the typewriter one-shots which are located in the same chassis.

$$G20 = \underline{Q2} Pe Fd D12 + - - -$$

$$G30 = G20 (\overline{Dt} + \overline{Uk}) \underline{Q2}$$

$$G50 = Pe G30 \overline{G20} \underline{Q2} + - - -$$

Therefore,  $G50 \overline{G30}$  becomes true about 30 milliseconds after  $D200$  relaxes.  $D200$  is now fired again, this time for leader.

$$sD200 = Pe \overline{W5} G50 \overline{G30} (\overline{R1} \overline{R2} \overline{R3} \overline{R4} \overline{R5} \overline{R6} \overline{Rp}) \underline{Q2} + - - -$$

This is a dc input term. Q2 is in the gate to prevent triggering D200 from a voltage spike due to logic cross-over, as  $\overline{W5}$  comes true and  $(\overline{R1} \overline{R2} \overline{R3} \overline{R4} \overline{R5} \overline{R6} \overline{Rp})$  goes false. (G50 may have been previously triggered from a typewriter action). The combination of  $\overline{W5}$  and  $(\overline{R1} \overline{R2} \overline{R3} \overline{R4} \overline{R5} \overline{R6} \overline{Rp})$  indicates that leader is required.

During the second D200 one-shot period the Fd flip-flop remains set and D4.5, Dp and D12 begin their cycling. The feed and sprocket punch solenoids are actuated.

$$Pf = Fd Dp$$

$$Psp = Fd Dp$$

The data channels are inhibited since the character in the character buffer is all zeros. The buffer is not clocked until the D200 one-shot relaxes.

$$\overline{Ecw} = (\overline{Pe} \overline{Dp} \overline{D200} \overline{Fd})$$

When D200 does relax, the buffer is clocked and data is punched character after character whenever there is information in the buffer ( $\overline{W5}$ ). Fd remains set once it has been set until the buffer no longer addresses the punch.

If it is required that the computer generate longer leader than the approximate inch provided by the D200 one-shot, the program must set up the buffer and again ask for leader. There must be a delay of about 1/2 second between the ENERGIZE OUTPUT M (02) instructions for more leader to be generated, since whenever the buffer is re-addressed, Fd is reset and one D200 period is necessary to set Fd again before leader can be punched. If an ENERGIZE OUTPUT M (02) is given by the computer to the W or Y Buffer every 1/2 second, leader will be generated about one-half of the time.

If leader is requested, the D200 one-shot is triggered twice regardless of the position of the toggle switch, "auto" or "run".

2. No leader is requested and the toggle switch is in the "auto" position. (See Figure 58.)

The D200 one-shot is triggered only once.

$$sD200 = Pe \overline{W5} \overline{Fd} \overline{Dp} \underline{Q2} + \dots$$

This term will not set D200 until the buffer has been loaded with some data, since W5 will be true until that time.

Pe causes the motor relay to close. The Fd flip-flop will not be set until D200 relaxes as before. The second term that sets D200 for leader will be inhibited as data will be in the character buffer when W5 is reset.

As soon as Fd is set, the data is punched out every 16.5 milliseconds. D4.5, Dp and D12 cycle and provide the proper timing. D4.5 must wait for D12 and for a new character in the buffer register, (W5).

3. No leader is requested and the toggle switch is in the "run" position.

When the switch is in the "run" position, not only is ac power continuously applied to the punch motor but a logic signal, (Kcp), goes true in the coupler chassis.

When the buffer addresses the punch requesting no leader, the Fd flip-flop is set immediately.

$$sF_d = P_e W_5 (K_{cp}) \underline{Q_2} \overline{F_d} + \dots$$

W5 indicates leader is not required. With Fd set, the D200 one-shot is inhibited even after information is loaded into the buffer by the computer, and since Fd is set, the punch can start punching without any delay as soon as the information is available.

Putting the punch toggle switch in the "run" position will inhibit the delay normally required to get the motor up to speed when the punch is being used by the buffer alternately with other devices and leader is not being requested. Failure to put the switch in the "run" position will not cause any difficulty but will cause unnecessary delay. The switch position can be changed while the punch is in operation.

### CIRCUIT CONSIDERATIONS

The punch solenoids are driven by SDS Circuit Module RK51. The solenoids are rated at 25 volts. However, these solenoids will not tolerate a 100% duty factor. To prevent burning out solenoids (due to a transistor or diode failure or by removing a logic circuit module from the coupler chassis), a resistor-capacitor circuit is wired in series with each solenoid. The 50-volt supply is applied to the common side of the solenoids, and the relay driver pulses the other side of the resistor-capacitor circuit to ground. A steady 50 volts applied across this circuit will not harm the solenoids.

### ADJUSTMENTS

The mechanical description of the punch is given in the manufacturer's manual which will be included as a part of the computer maintenance manual. Two adjustments are fairly common:

1. The hole spacing on the punched tape should be 10 per inch. There is both a coarse adjustment and a fine adjustment for this spacing. (See vendor's manual, page 22, "Capstan Adjustment".)

2. The feed solenoid actually closes a set of contacts which, in turn, actuate the escapement magnets. The timing of the closing of these contacts should be adjusted to 10.5 milliseconds after the feed solenoid is pulsed. This period is longer than is recommended by the manufacturer, but because of the resistor-capacitor circuit, the pulse to the escapement solenoid is not square. Improper timing of the escapement solenoid will cause sprocket holes in the paper tape to be stretched or torn.

### Timing Diagrams

The data punching timing diagrams are on the following pages.



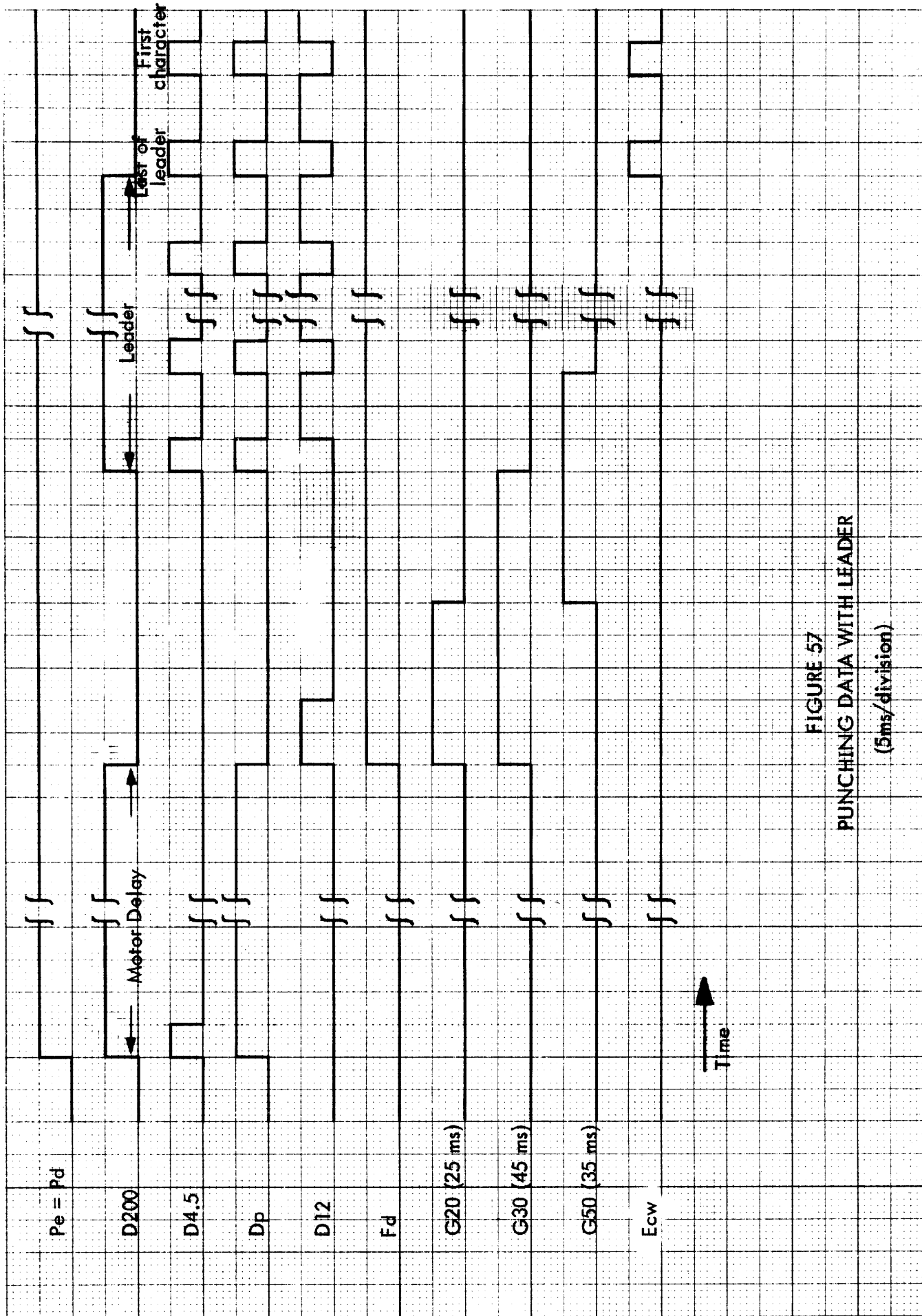

FIGURE 57  
PUNCHING DATA WITH LEADER  
(5ms/division)

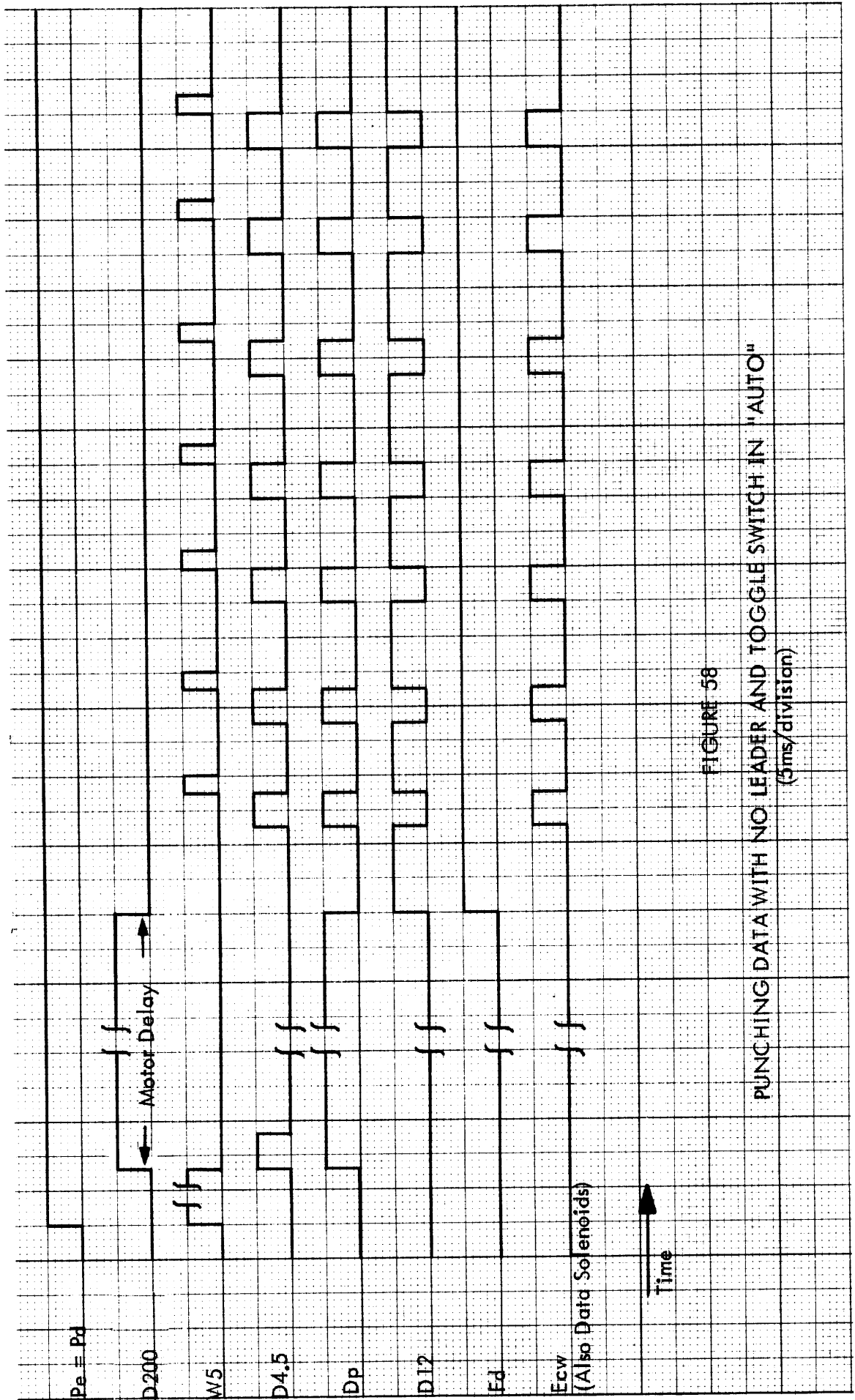

FIGURE 58

PUNCHING DATA WITH NO LEADER AND TOGGLE SWITCH IN "AUTO"  
 (5ms/division)

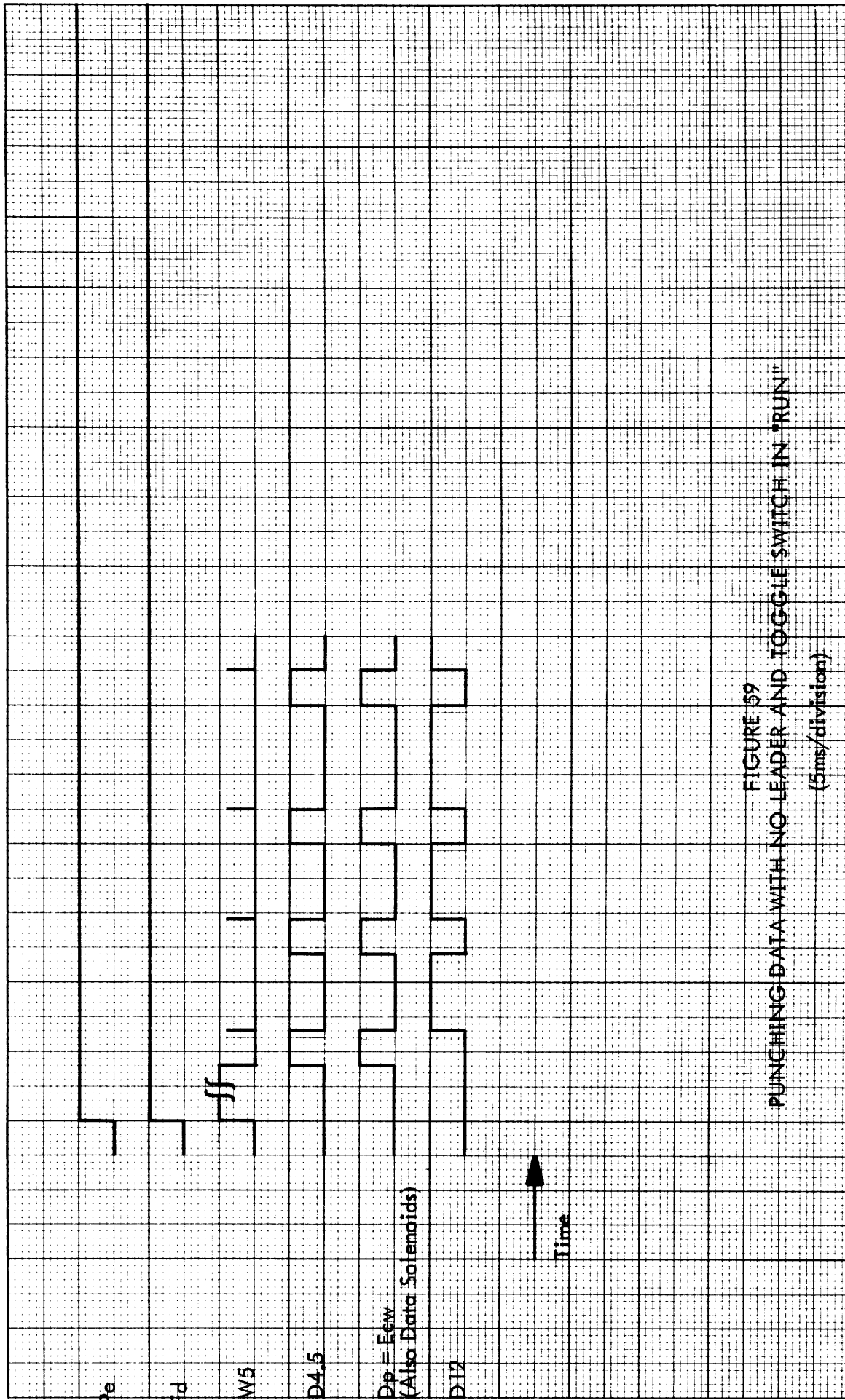

FIGURE 59  
 PUNCHING DATA WITH NO LEADER AND TOGGLE SWITCH IN "RUN"  
 (5ms/division)

## DICTIONARY OF TAPE PUNCH LOGIC TERMS

- D4.5 A one-shot used to time the current pulse to the punch solenoids.
- D12 A one-shot that determines the time interval between punch solenoid pulses.
- D200 One-shot used to time leader generation and to allow punch motor to get up to speed before punching.
- Dp An interlock flip-flop used with D4.5 and D12 to provide timing pulses to the punch solenoid drivers.
- Ecw The clock signal to the W Buffer.
- Fd Flip-flop that allows punching.
- G20-G30-G50 Typewriter one-shots used by the punch logic to provide delay between firing the D200 one-shot.
- Kcp Signal from "Auto - Run" toggle switch on the punch panel. Signal is true when switch is in the "Run" position.
- Ksp Signal from "Feed" button on punch panel to the punch coupler.
- Pd Punch Motor Relay Driver.
- Pd1-Pd7 Data channel solenoid drivers.
- Pe Punch "enable" amplifier.
- Pf Feed solenoid driver.
- Psp Sprocket hole solenoid driver.

## TAPE PUNCH LOGIC EQUATIONS

### Enable

$$Pe = W9 \overline{W10} \overline{W11} W12 \overline{W13} \overline{W14}$$

### Punch Motor Relay Driver

$$Pd = Pe + (Ksp)$$

### Delay Timer & Leader Generator

$$sD200 = (Pe \overline{W5} + (Ksp)) \overline{Fd} \overline{Dp} \underline{Q2} + Pe \overline{W5} G50 \overline{G30} (\overline{R1} \overline{R2} \overline{R3} \overline{R4} \overline{R5} \overline{R6} \overline{Rp}) Q2$$

$$sFd = Pe W5 (Kcp) \underline{Q2} \overline{Fd} + D12 Dp \underline{Q2}$$

$$rFd = (\overline{Pe} \overline{Ksp}) \underline{Q2} Fd$$

$$sG20 = Pe \overline{Fd} D12 \underline{Q2} + - - -$$

$$sG30 = G20 (\overline{Dt} + \overline{Uk}) \underline{Q2}$$

$$sG50 = Pe G30 \overline{G20} \underline{Q2} + - - -$$

### Pulse Control

$$sD4.5 = (Pe \overline{W5} + (Ksp)) \overline{D12} \overline{Dp} \overline{G30} \underline{Q2}$$

$$sDp = D4.5 \overline{D12} \underline{Q2} \overline{Dp}$$

$$rDp = D12 \underline{Q2} Dp$$

$$sD12 = Dp \overline{D4.5} (\overline{D200} + Fd) \underline{Q2}$$

### Clock

$$(Ecw) = \overline{(Pe Dp \overline{D200} Fd)}$$

### Solenoid Drivers

$$P_f = F_d D_p$$

$$P_{sp} = F_d D_p$$

$$P_{d1} = R_6 (P_e F_d D_p)$$

$$P_{d2} = R_5 (P_e F_d D_p)$$

$$P_{d3} = R_4 (P_e F_d D_p)$$

$$P_{d4} = R_3 (P_e F_d D_p)$$

$$P_{d5} = R_2 (P_e F_d D_p)$$

$$P_{d6} = R_1 (P_e F_d D_p)$$

$$P_{d7} = R_p (P_e F_d D_p)$$